

2026 APBA Rules for Inboard Racing

ISSN #1549-604X



As of 3/30/2026

The rules and/or regulations set forth herein are designed to provide for the orderly conduct of racing events and to establish minimum acceptable requirements for such events. These rules shall govern the condition of all APBA events. And, by participating in these events, all APBA members are deemed to have complied with these rules. No express or implied warranty of safety shall result from publications of, or compliance with, these rules and/or regulations. They are intended as a guide for the conduct of the sport and are in no way a guarantee against injury or death to participants, spectators, or others.

INBOARD WEBSITE: www.apba.org/inboard-category.html

E-mail: inboardracing@apba.org

The **Technical Manual for Inspection and Measurement of the Racing Runabout** and the **Technical Inspection Manual and Guide to Measuring the Racing Crackerbox** are located in the Appendix of these rules and on www.apba.org under **RESOURCES**.

Printed copies of these rules, or rules for other categories of racing, are available from APBA, 4401 S. Charleston Pike, Springfield, Ohio 45505

Phone (586) 773-9700

E-mail: APBAHQ@apba.org; Website: www.apba.org

All **2026 changes appear highlighted; deletions are in red.**

Rules that appear in *italic* are also contained in the APBA General Racing and Safety Rules.

General Racing Rules take precedence over those written by any category. Categories, when writing rules regarding a subject covered by General Racing Rules, may only add more restrictive details. These more restrictive rules will then prevail for that category.

Any changes made to the APBA General Racing and Safety Rules must also be incorporated into the corresponding Inboard rules. Conversely, no change should be made to these rules that contradicts the APBA General Racing and Safety Rules.

NOTE: Rule changes and corrections may occur throughout the year.

They will be printed in *Propeller* magazine and/or placed on the APBA and Inboard websites.

Check www.apba.org and www.apba.org/inboard-category.html periodically to make sure you have the most recent rules.

© Copyright 2019-2024 by the American Power Boat Association. All rights reserved.

Copy of any portion of this book by others is prohibited without first obtaining consent of the copyright owners.

2025 INBOARD RACING RULES

RULE 1 - GENERAL SAFETY RULES

The considerations below are meant to provide an awareness that safety must be everyone's first priority NOW, not after a problem occurs.

- 1.1 Racing is an inherently dangerous sport and each competitor assumes the risk when he/she participates in an event. While everyone involved—owners, drivers, crew members, officials, promoters, and the sanctioning body—can take, and have taken, measures to reduce the risk of serious injury, the risk cannot be eliminated and, in fact, will always be present. It is the participant's responsibility to advise their spouses and next of kin APBA cannot be, and is not, responsible for all or even most aspects of the safety effort. That responsibility instead rests with the various participants in the events as follows:
 - 1.1.1 *APBA officers, officials, agents, and representatives are not present at APBA events with sufficient frequency to make any representations or warranties of safety to any competitor or other person. As a result, APBA cannot and does not take responsibility to ensure the adequacy—for purposes of safety—of the racing facility, safety personnel or equipment, or conditions of the premises including the waterway. The participants are solely and ultimately responsible for satisfying themselves as to the safety of the premises, pit areas and race course.*
 - 1.1.2 *All participants are obligated to inspect the racing facilities, including the pit area and race course, including all of the conditions that would affect their participation in, before, and after the event. Participants are solely and directly responsible for the safety of their race craft and racing equipment; are obligated to perform their duties whether as an owner, driver, or crew member in a manner designed to minimize, to the degree possible, the risk of injury to themselves and others. NEITHER APBA NOR THE PROMOTER OR CONDUCTING CLUB CAN OR WILL BE RESPONSIBLE FOR THE ADEQUACY OF A PARTICIPANT'S RACE CRAFT, RACING EQUIPMENT, OR RACING ACTIVITY TO ACCOMPLISH THIS PURPOSE.*
- 1.2 *No contestant shall participate in a race, nor shall any official serve in an official capacity, after having consumed alcohol or controlled substances or while intoxicated. The phrase "after having consumed" shall mean from midnight before the day of the race and until the driver has been cleared through inspection. Intoxicated means under the influence of alcohol, a controlled substance, any drug, or any combination of the above, such that there is an impaired condition of thought and action and the loss of normal control of a person's faculties to such an extent as to endanger any person.*
 - 1.2.1 *At all APBA sanctioned Inboard Racing Regattas a Breathalyzer test may be required of any participant (anyone required to sign the insurance participant form) under the following guidelines:*
 - a. A Race Committee may, at the time of issuing a sanction, set in place a program to test any or all participants.
 - b. The Referee has the authority to require any or all participants (including non-member holders of hot pit passes) to submit to a Breathalyzer test.
 - c. The Risk Manager or Race Director shall have the authority to require the referee to submit to a Breathalyzer test and/or to ask the referee to test any participant.
 - d. Permissible Breathalyzer tests include:
 - 1) Breathalyzer test administered by Police, Sheriff, or other qualified agent.
 - 2) Over-the-counter Breathalyzer test administered by the Referee or his designee. Participants failing this type of test may pursue, at their own expense, a retest as listed in 1.2.1d.1 to verify results. The retest must be administered on site under the observation of the referee or his designee.
 - e. Tests may be administered on race day from 7:30 AM until one-half hour after the final heat has concluded.
 - f. Criteria and Consequences:
 - 1) The maximum allowable test limit shall be no greater than 0.00 BAC. Refusal to take the test will be considered a failed test and the consequences outlined below apply.
 - 2) In a given Race Year (1 Nov. - 31 Oct.):
 - First violation—The offender shall be suspended for the remainder of the event and shall not be allowed to participate in any capacity (event defined as all dates stated on the sanction).
 - Second violation—Suspension as above, review by the IRC, and subject to penalties up to and including a 12-month suspension from involvement with APBA Inboard Racing.
 - 3) A pattern of infractions over multiple racing seasons will be subject to review by the IRC and to penalties up to and including a lifetime suspension from involvement with APBA Inboard Racing.
 - 1.2.2 *Alcohol and non-prescribed drugs are strictly forbidden on any rescue/patrol turn judge boat, and none of the associated personnel shall be allowed to consume alcohol until all race related duties have been completed and they are released by the Race Rescue Director. Caution should be exercised that prescribed medication should not alter the rescuer's ability to perform their duties, mentally or physically. The Race Rescue Director shall have the discretion to place a rescuer off duty if he or she determines that the rescuer is not performing effectively or is endangering their own or others' safety.*
- 1.3 No contestant shall participate in an APBA-sponsored event with any type of splint, including, but not limited to, a cast or brace applied to his body without showing written authorization from a medical doctor and approval by the Referee at the particular event.

RULE 2 - SAFETY INSPECTION

- 2.1 Safety Inspectors are required to inspect and certify all boats competing in any National, Divisional, or National Series once a year using the official Inboard "Equipment Inspection Checklist" supplied by the APBA office prior to the event. The inspector, at the first race of the season that the boat attends, will verify compliance to all safety related rules applicable to that boat. A certification inspection is required at the first event an owner enters with a new boat/restraint capsule. The inspector will sign off if no discrepancies are found and will issue an Inboard Safety Sticker, to be placed on the transom of the hull in plain view.
 - 2.1.1 *A safety inspection of each entry may be made by the Inspector or his designee at any APBA Inboard sanctioned race.*

- 2.1.2 A driver's ability to open and exit from the bottom escape hatch will be a part of the inspection procedure.
- 2.2 If a discrepancy is found at the first race, or any other race thereafter, the inspector will classify the problem as follows:
 Level 1 - Discrepancy found - boat not allowed to compete.
 Level 2 - Discrepancy found - allowed to compete/fix before next event.
 Level 3 - Involved in accident - repairs required before next event.
- 2.2.1 The inspector will complete an Equipment Discrepancy Report and remove the Inboard Inspection sticker from the transom for Level 1 and Level 3 Discrepancies. For Level 2 Discrepancies, the Inboard Inspection Sticker will be marked with a large "2" and dated; the sticker shall be removed at the end of the weekend's competition. Copies of this report will be submitted to the referee to forward to the Inboard office for filing, and a second copy will be given to the boat owner.
- 2.2.2 Prior to registering for the next event, an owner with an open discrepancy or damage item must submit his boat and his copy of the Equipment Discrepancy Report to the inspector for re-registration. Only approved APBA Inboard Inspectors can sign off that a modification/ repair has been completed.
- 2.2.3 When the inspector approves the modifications, he affixes a new Inboard Inspection sticker to the transom. The inspector also takes the owner's copy of the Equipment Discrepancy Report, fills out the correction section, and submits it to the referee to be forwarded to the Inboard office for filing.
- 2.2.4 Inspectors can refuse to close items if the modifications are not satisfactory; or can open a new item found as a result of an unacceptable change.
- 2.2.5 Under no circumstances can an owner be given a second chance to compete with an open "Level 2 Discrepancy."
- 2.2.6 Discrepancy report disputes can be filed with the Inboard Safety Council Chairman for review. The appropriate persons will be contacted to settle the dispute.
- 2.3 The penalty for altering or forging safety inspection documents shall be \$1,000 and/or a 60-day suspension as decided by the Inboard Racing Commission and the Inboard Chairman.
- 2.4 At the discretion of the Inspector, the Race Rescue Director shall safety inspect specific designated points on the safety inspection sheet and report any discrepancies found to the Inspector.
- 2.5 *If requested, it is the responsibility of the driver or owner to submit his equipment for safety inspection. If, in the judgment of the Inspector or Referee, a boat is unseaworthy, unsafe, or unmanageable, he shall refuse to allow the boat to participate in the race. The Referee, at his discretion, may require any flipped boat or boat involved in any accident to be reinspected before entering another heat of racing.*
- 2.6 *In the event that any competing boat is damaged during a heat or a race, it shall be inspected before returning to competition. The driver must report any damage to the inspection committee or referee. Where repairs to damage are made during a race, the boat must be inspected and approved upon completion of such repairs in order to continue in competition. Failure of a driver to report such damage or repairs renders him liable to disqualification.*

RULE 3 - SAFETY EQUIPMENT

- 3.1 Drivers and riding mechanics, when in competition, are required to wear uniforms with tight-fitting cuffs at the ankles and wrists. These uniforms must be made of Nomex or a comparable fire-retardant material. Closed footwear is required.
- 3.2 *When driving or riding in any racing craft, eye protection in the form of a helmet face shield, goggles or ANSI/OSHA approved safety glasses with restraint straps shall be mandatory.*
- 3.2.1 *A full canopy is described as "a cover for the top of the reinforced cockpit which completely encloses the driving compartment and is securely fastened". Canopies meeting this criterion shall be considered sufficient eye protection.*
- 3.3 All participants must wear footwear in the pits. Drivers, riders, crew members and pit personnel are required to wear closed footwear in the pits.
- 3.4 *Considering the fact that there are no safest life jacket and helmet that will eliminate all risks, the participants are solely and ultimately responsible for selecting a suitable helmet and life jacket. Only those considered in good condition will be permitted to be used.*
- 3.5 **HELMETS**
- 3.5.1 *Drivers and riding crew are required to wear helmets at all times while on the water for the purpose of racing or testing. The helmets may be removed only if the craft is under tow or being held fast in the infield by an official tow boat. Violators will be disqualified and suspended for thirty (30) days. Exceptions may be granted by the referee for unusual situations. All suspensions and exceptions granted must be reported, in writing, to the Chairman of the Inboard Racing Commission immediately following each incident.*
- 3.5.2 *Helmets shall meet one of these rating specifications: Snell 2015 or newer (SA, M, K, CMR/CMS 2007, CMH); SFI competition 31.1 and 31.2; SFI spec 24.1 youth helmet for drivers age 16 and under. Beginning in 2023 ratings must be no greater than 12 years from rated date code (i.e., SNELL2015 rating good through the beginning of the 2027 season).*
- 3.5.2.1 *The majority (>50%) of the helmet must contain one or more of the following colors: yellow or fluorescent (high visibility) yellow or lime green or orange or international orange or fluorescent red. Additional artwork or lettering is acceptable as long as the majority color(s) are maintained. This area is not to exceed 8" wide x 2" high.*
- 3.5.2.2 *Half-shell and 3/4 type helmets are not allowed.*
- 3.5.3 *Drivers/Riders not in restraint capsules shall wear helmet support straps (lanyards) secured to the driver's/ rider's body as required or a Head and Neck Restraint device. APBA will make no recommendation on which device to use but, must be manufactured for use in motorsports for unrestrained drivers.*
- 3.5.4 No image recording devices may be attached to helmets for unrestrained drivers. Restrained drivers may use a device that weighs less than 60 grams. Not to be attached to top of helmet. Must be attached to the visor, chin or inside helmet. No holes are permitted to be drilled in the helmet shell for camera attachment.

- 3.5.3.1** Empirical data is showing that when the camera does not disengage immediately upon water impact it can lead to a neck injury. The camera acts as a keel and creates drag using the neck as the fulcrum.

3.6 LIFE JACKETS

- 3.6.1** *Life jackets: All racing life jackets must be constructed in compliance with the “APBA Life Jacket Basic Manufacturing Specifications” dated March 1, 2013. Copies are available from APBA National Headquarters.*
- 3.6.2** *All racing life jackets must have a permanently affixed (sewn in) manufacturer’s label that indicates: The date of manufacture or the date of recertification, and the manufacturer’s or recertifier’s company name.*
- 3.6.3 Life jacket category (A, A-100, B or C)**
- “A” For use in an open and unrestrained cockpit. Maximum boat speed is less than 100mph.*
- “A-100” For use in an open and unrestrained cockpit. Maximum boat speed is 100mph or greater. A-100 may also be used where A is required.*
- “B” For use in a driver restrained cockpit not necessarily employing supplemental life support equipment needing life jacket accommodations.*
- “C” For use in a driver restraint cockpit that does employ supplemental life support equipment.*
- 3.6.4** *All “A” and “A-100” lifejackets are required to have 70% of the upper surface, both front and back, orange or yellow in color; skid collars must be orange.*
- 3.6.5** *Lifejackets must be securely fastened at all times while on the race course, for racing or testing. Any driver removing his lifejacket or racing with a lifejacket that does not meet the approved guidelines shall be disqualified and suspended for thirty (30) days. Exceptions may be granted by the referee for unusual situations. All suspensions and exceptions must be reported, in writing, to the Inboard Chairperson immediately following each incident.*
- 3.6.6** *Lifejacket specifications for use by an unrestrained driver: The lifejacket must be designed for racing, with leg straps or thigh skirts securely fastened to the jacket. There must be a minimum of 1/4” thickness of impact material covering the back and sides, and safety tapes over any zippered seam. The jacket shall have a puncture and tear resistant outer covering (e.g. ballistic material which meets or exceeds the following: Mil Spec Flay Nylon, Mil Spec C-476, Bright High Tenacity Nylon, 210 Denier, 3.6 oz per sq. yard, Count 62x50. Break strength 225 pounds warp, 152 pounds fill. The jacket must be capable of meeting USCG Type II flotation perUL standard 1123, but with a minimum flotation of 18 pounds and 10% flotation imbalance. All jackets must be equipped with skid collars. The skid collar shall contain a single piece of 1/4 thick (minimum) Ethofoam 900 which covers continuously from top inner edge of the jacket to a minimum of 2” past the base of the helmet when the wearer is standing in an erect position with the head looking toward the horizon and the lifejacket worn in accordance with manufacturer’s instructions. The axial coverage shall be from 110 degrees to 250 degrees minimum, measured from the midsagittal plane (basically from the back of the ear to the back of the other ear around the back of the head). The outer covering shall be any synthetic material which is fungus- and mildew-proof (e.g. nylon, Dacron, etc.) which is of equal or greater thickness than the material used as the jacket covering. The thread used to stitch the skid collar to the jacket shall also be fungus- and mildew-proof. This collar may be incorporated with, or in addition to, other collars which may be present.*
- 3.6.7** *Drivers in restrained racing vessels must wear a lifejacket or flotation that provides positive buoyancy.*
- 3.6.8** *In boats equipped with a Type 3 or 4 restraint capsule a driver may elect not to wear a life jacket when competing, but instead choose to wear either a flotation vest inside his/her racing uniform or a driver’s suit manufactured with flotation as part of the driver’s suit.*

3.7 BOAT SAFETY

3.7.1 Propeller shaft safety collars. Safety collars in all classes shall be machined from bar stock, not pressed metal (sintered iron). In runabout classes, safety collars must be configured so they will prevent the shaft and propeller from sliding back and hitting the rudder should the thrust bearing come apart or loose on the shaft. They must be located within 0.5 inches of the leading end of the strut or within 0.5 inches of the shaft log assembly. Couplers between the gearbox shaft and the propeller shaft on runabouts shall be a minimum of 4.75 inches long and utilize a minimum of 5 clamping bolts. Set screws shall be used in each end of the coupler. Each shaft shall be dimpled to receive set screws. In Inboard classes the safety collar for smooth round propeller shafts must be of the split-type configuration or have two set screws and the shaft shall be dimpled to receive those screws. A splined propeller shaft with a grooved undercut to receive two axial restraint bolts can also be used with a splined safety collar.

3.7.2 *All boats must be equipped with a positive return throttle, insuring that the throttle plate returns to a normally closed position when throttle pressure is released.*

3.7.3 *Hulls without restrained drivers must be equipped with an electric kill switch, or fuel shut-off valve. It must be capable of stopping the engine if the driver is separated from the boat. The safety kill switch or fuel shut-off valve tether or lanyard must be securely attached to the driver’s life jacket.*

3.7.4 *The recommended depth of rear “shoes” or “sponsons” is no more than 75% of the distance from the bottom of the hull to the center line of the propeller shaft, at the transom.*

3.7.5 *All hydroplanes and runabouts must have suitable flotation which will float the hull, motor, and driver in a swamped state. It will be the responsibility of each owner to verify if his crafts flotation is adequate and they may be asked to indicate location of the flotation for runabouts with restraint capsules it is recommended that flotation be placed in a location to help upright a capsized hull. Flotation should be placed in the left (port) side, and mechanically fastened to the capsule and stringers, based on a maximum of 60 lbs. per cubic foot.*

3.8 HARDWARE MATERIAL SPECIFICATIONS: The following specifications are recommended in all Inboard classes, but mandatory in the Grand Prix class.

3.8.1 Rudders: Many different materials and design configurations will work. The following should be considered when building a rudder.

- Aluminum - 7075-T651 is acceptable; Steel - 4140, 4340, 174 PH alloys are acceptable if properly heat treated.
- The material grain MUST be in the length dimension to insure that the greatest strength can be reached. NEVER paint a rudder. This hides cracks. Anodizing for aluminum and zinc plating for steel would be acceptable. NEVER machine to a sharp corner; always radius edges.
- Pivot Pins - Stainless is not the strongest nor the best. Materials of a high fatigue quality like 1045 steel are better and readily available. NEVER weld or braze a rudder. NEVER straighten a bent rudder and reuse until it has been stress relieved, annealed, and re-heat treated.

3.8.2 Rudder Brackets:

- Eliminate cast aluminum or bronze brackets.
- Fabricated aluminum plate, bolted and doweled, is acceptable.
- Steel weldments, or bolted and doweled, is acceptable.
- Billeted of bar stock construction would also be acceptable.
- A particular type or grade of material is not the major consideration.

3.8.3 Skid Fins: *Aluminum - 7075-T651 is acceptable; Steel - 4140 or 4340 alloys are acceptable only if properly heat treated. Grain MUST be in the length direction. Bolts, draw rods, clevises, etc., are and should be a major consideration with the skid fin.*

3.8.4 Struts:

- Eliminate cast struts in aluminum or bronze.
- Designs are optional.
- Consider a steel "V" type weldment or other type of fabricated construction.
- The materials used are not the major consideration in struts as long as they are of plates or billeted construction.

3.8.5 NON-DESTRUCTIVE TESTING (NDT), *such as magnetic particle, dye penetrate or other processes, is recommended annually for propellers, shafts, couplers, rudders, skid fins, brackets, struts and other critical hardware. Following an accident, it is recommended that NDT be performed prior to competition.*

3.9 SLINGS: All slings shall be manufactured to industry standards. The slings must be identified by a serial numbered patch or identification tag. The slings must have an original manufacture rating displayed on the patch or identification tag. A dated receipt from the manufacturer or vendor referencing the sling shall establish entry into service date during the initial service period prior to the first required manufacturer visual inspection.

The minimum sling standards for each class are as follows:

4 leg sling = the minimum weight of the boat per leg

3 leg sling = 1.5 times the minimum weight of the boat per leg

2 leg sling = 2 times the minimum weight of the boat per leg

1 leg sling = 2.5 times the minimum weight of the boat

EXAMPLE: A 3 leg sling E 350 would have overall minimum rating of 6864#. (1525# x 1.5 = 2288# per leg x 3 legs = 6864# minimum)

A single point lift 2.5 Litre Stock minimum would be 2563#

A four point lift 2.5 Litre Stock minimum would be 4100#.

Any sling leg angle to horizontal minimum under load shall be no less than 30 degrees.

3.9.1 All slings shall be inspected by a recognized industrial sling manufacturer every five years. A dated letter of verification from said manufacturer of satisfactory condition, with the sling serial number or identification number, shall be required. If said inspection reveals that repairs are required, an industry-accepted proof test shall be performed; both the repair and the proof test results shall be stated on the dated letter of verification. A dated receipt from the manufacturer or vendor referencing the sling shall establish entry into service date during the initial service period prior to the first required manufacturer visual inspection.

INSPECTOR: Visual sling inspection shall note abraded, frayed or torn material, breakage, missing attachment components, heat damage, environmental damage, etc.; any of these conditions will deem the sling be removed from service. This does not preclude an inspector's right to deem a sling unsafe.

All lifting hardware on the boat must be of sufficient strength, and attached properly for safety inspection, as to support the entire weight of the boat from any one of the lifting points. All lifting hardware must be visible.

3.10 AIR SYSTEM: A full-time onboard air system is mandatory for all boats competing with an F-16 type structural canopy, and is recommended for all drivers in reinforced cockpit boats.

1) *Type 4 capsule (F-16 type structural) – mandatory; 30 cu. ft. air tank capacity mandatory.*

2) *Type 1, 2, 3, - recommended; 30 cu. ft. air tank capacity recommended.*

The following guidelines must be followed.

3.10.1 *The driver's mask must cover the driver's nose and mouth and be designed to be watertight. The mask must be attached in such a way as to prevent its being dislodged or removed inadvertently and must be worn by the driver anytime the boat is under power. An ambient air valve is allowed; an ambient air valve is required when air tank capacity is less than 30 cu. ft. The mask shall be worn by the driver anytime the boat is under racing or testing conditions.*

3.10.2 *Air tank: All tanks regardless of size shall be designed for the delivery of breathing air. All inboard boats with a permanent onboard air system and an F-16 structural style canopy in place must carry a minimum of 30 cubic feet of air, regardless of mask type. A 30 cubic foot bottle is highly recommended for all boats with a safety cell other than that of the F-16 style, provided they have a mask and a functioning ambient air valve. All air delivery systems, whether permanent or part time, shall carry air in a vessel approved and certified for the delivery of breathing air. The tank shall be stamped to verify inspection and certification of the tank to meet D.O.T.*

(US Department of Transportation) or T.C. (Transportation Canada) standards. All components of the air system shall be rated for use with compressed air and with the pressures utilized. All connections in the air system shall meet diving industry standards (SCUBA type), including high pressure, crimped hose ends. Hose clamps, push-lock or similar low pressure connections are not allowed. The air tank shall be securely mounted to the boat; a commercially made driver worn holster is acceptable only for appropriately sized tanks.

3.10.3 A quick release pressure sealing coupler shall be used to connect the air supply hose from the tank (first stage regulator) to the driver mask hose (second stage regulator); the driver mask hose length shall be 10 inches (min) to 36 inches (max) to the connection; the air supply hose from the tank to the driver mask hose connection shall be ten (10) to fifteen (15) feet long; measured starting at the center of the steering wheel. The female coupler fitting shall be attached to the air supply hose from the tank; the male coupler fitting shall be attached to the driver mask hose. A tee block with two male coupler fittings, attached to the driver mask hose, is allowed. Parker part number SH1-62 / SH1-63 (or other manufacturer interchange) is the accepted design sealed coupler assembly; stainless steel material is highly recommended, brass is an acceptable alternative. All connections in the air system must be done with commercially accepted or SCUBA type, high pressure crimped ends. Hose clamps are not allowed.

3.11 CAPSULE TRAINING: All drivers and riders of Inboard boats with restraint capsules are required to successfully complete an APBA Approved Inboard Capsule Training Program. Training programs will be approved by the Inboard Racing Commission and conducted by an approved APBA Inboard Rescue Team.

3.11.1 When capsule training is completed prior to October 1, capsule training documentation shall be valid for the racing season in which the training was taken and also for the following racing season ending October 31.

- When capsule training is completed during October, capsule training documentation shall be valid for the racing season in which the training was taken and also the following two (2) racing seasons ending October 31.
- To avoid expiration, it is recommended that training be done annually.

3.11.2 APBA APPROVED CAPSULE TRAINING CRITERIA: All procedures discussed in detail with the driver before they are carried out. Drivers must indicate that they understand the procedure to be carried out and are comfortable with it prior to each exercise. APBA Capsule Training for drivers shall be performed under the following conditions: 1. controlled environment; 2. no water current; 3. minimum underwater visibility 4 feet ; 4. minimum two (2) certified divers shall be in the water while training is conducted; 5. divers must be able to clearly see the driver and the driver's face throughout the training exercise; 6. minimum water depth shall be 5 feet, maximum water depth recommended is 15 feet. It is highly recommended that APBA Capsule Training shall take place in a swimming pool.

- Orient driver with procedures and drill.
- Familiarization with driver's air system.
 - 1) Driver demonstrates knowledge of operation and proficiency with his equipment.
 - 2) Driver demonstrates ability to utilize and clear his system in the pool with divers standing by.
- Familiarization with diver's SCUBA regulator.
 - 1) Function and use of regulator explained.
 - 2) Demonstration of methods to clear regulator.
 - 3) Explanation of breathing techniques, i.e. **DO NOT HOLD YOUR BREATH!**
 - 4) Driver demonstrates use of regulator underwater.
 - 5) Driver demonstrates how to clear regulator.
- Familiarization with capsule safety equipment and function, i.e. steering wheel release, harness release and canopy release.
 - 1) Driver demonstrates ability to release steering wheel, harness, and canopy.
- Orient driver on procedures to extricate himself from the capsule.
 - 1) Review extrication procedures. (1) canopy (2) wheel (3) safety harness (4) roll forward and out
 - 2) Explain proper method for exiting capsule (driver rolls forward into a "C", coming up in front of boat)
 - 3) Explain signals to be used
 - a) Driver ready (thumbs up)
 - b) Driver needs help (a clenched fist held out); safety divers will extricate.
 - 4) Go over procedure to be followed; when signals are to be given, safety procedures, how drill will be conducted.
 - 5) Driver is strapped into capsule with a SCUBA regulator.
 - 6) Driver is asked if he is ready and signals he is ready.
- Driver is flipped and allowed to extricate himself using SCUBA air.
- Driver is strapped into capsule using his own air system.
 - 1) Diver is asked if he is ready and signals he is ready.
- Driver is flipped and allowed to extricate himself using his own air system.
- Optional: Driver is strapped into capsule using either his own air system or a SCUBA regulator with mask/visor blacked out.
 - 1) Driver is asked if he is ready and signals he is ready.
 - 2) Driver is flipped and allowed to extricate himself using his own air system or SCUBA.
- Driver should be wearing his flotation device and helmet he wears while racing. It is recommended that the driver also be wearing his driving suit and shoes.

3.11.3 In addition, at race sites or other location, a referee or inspector may require the driver to:

- Demonstrate that he can adequately extricate himself from a safety team test cell, both on land and under water.
- Demonstrate that he can extricate himself from the cockpit of the boat he intends to drive prior to any event.
- Complete any further test, including a driving test, under the supervision of the Inboard Racing Commission or their designee,

to demonstrate that he can participate in an event without representing an unjustifiable risk or endangerment to himself or others.

- 3.11.4** *The evaluation of any of the above tests are within the sole discretion of the Inboard Racing Commission and not subject to protest or appeal.*
- 3.11.5** *All members who have passed Capsule Training set forth in Rules 3.11.2 – 3.11.4 shall be eligible to compete in the Jersey Speed Skiff Class*
- 3.11.6** *Competitors in a Jersey Speed Skiff with an enclosed safety capsule, as defined in Rule 3.12.1, Type 2 and Type 3 must successfully complete a current APBA approved Inboard Capsule Training Program.*
- 3.11.7** *The following training may be used for Jersey Speed Skiff competitors, but does not qualify the member for any other class which has a capsule:*

A) Familiarization with diver's SCUBA regulator.

- 1) Function and use of regulator explained.*
- 2) Demonstration of methods to clear regulator.*
- 3) Explanation of breathing techniques, i.e. DO NOT HOLD YOUR BREATH!*
- 4) Competitor demonstrates use of regulator underwater.*
- 5) Competitor demonstrates how to clear regulator.*

B) Harness Release

- 1) Competitor demonstrates ability to:
 - a) Follow zipper of life jacket down to the harness release mechanism*
 - b) Release mechanism*
 - c) Competitor demonstrates ability to exit roll cage by rolling forward, or going straight up through cage**

The skiff trainer (PVC roll cage and seat, or other approved training device) shall be used. When using this device, competitor shall be strapped in, and then it will be submerged right side up. Competitor shall then demonstrate ability to extract himself/herself from the cage as described above.

3.12 RESTRAINT CAPSULES:

3.12.1 *The general term "Restraint Capsule" encompasses all the following type capsules that protect a restrained driver. For specific restraint capsule guidelines, refer to the guidelines for the construction of all Restraint Capsules that are available from the Inboard Office.*

Type 1 - Capsules constructed of steel tube with water deflection without canopy. Type 1 capsules are not to be used in new hydroplane construction after November 1st, 2011.

Type 2 - Capsules constructed of composite materials without a canopy.

Type 3 - Capsules constructed of composite materials fitted with canopy which is not designed to withstand a hard impact.

Type 4 - Capsules constructed of composite materials reinforced with a steel or composite tubing roll cage fitted with structural canopies and bottom hatches designed (flatbottom hulls are not required to have a bottom hatch) to withstand a hard impact.

3.12.2 *It is mandatory that all boats competing in the Inboard hydroplane classes, have registered reinforced cockpits; and that the JSS class has registered reinforced cockpits or roll cages.*

3.12.3 *All hulls in the SS class, PS class, and the K Racing Runabout class are required to have registered reinforced cockpits.*

3.12.4 *Any inboard hydroplane, SS, PS, or K racing runabout must be equipped with a registered reinforced cockpit of Type 2, 3, or 4 construction to be eligible to participate in a time trial (Kilo).*

3.12.5 *Mandatory standards for all restraint capsules include:*

- Minimum 2" clearance above driver/riding mechanic to cockpit or canopy.
- The top of the front of the cockpit will be a maximum of 4" below eye level.
- Minimum 1/2" (9 lbs) Ethofoam support behind driver/riding mechanic's head to prevent slapping rear of cockpit with helmet. No sharp edges or protrusions anywhere inside or around entry-way of cockpit. Energy absorbing foam padding to be strategically placed inside cockpit area where head, arms, hands, knees, etc., might impact.
- The cockpit area must be completely sealed off from the engine compartment to prevent the intrusion of fire, fuel or harmful vapors in the cockpit. Openings for restraint harnesses, wiring, cables, hoses, etc. must be kept to a minimum. The use of grommets or other types of sealing devices are recommended around these openings.
- When drilling and/or mounting into capsules, all coring must be coated with epoxy. When mounting, an aluminum or stainless steel sleeve with a washer machined or welded to the sleeve. Or make hard spots; epoxy and Cab-O-Sil or fumed silica must be used to create the hard spot. The hard spot must be 3-times larger than the diameter of the bolt being used for mounting. If using an aluminum or stainless steel sleeve, the sleeve must be mechanically fastened with epoxy, thus sealing the exposed coring.
- All canopies must have an external handle or hand hold opening.
- All hydroplanes must have a rollover lift bracket or eyelet permanently attached to the rear area of the left sponson. The bracket or eyelet must have at least a 3/4" hole and be strong enough to support the weight of the boat should it need to be righted for rescue purposes. The skid fin bracket would be considered a rollover bracket and does not need to have the 3/4" hole.
- The restraint capsule must have enough flotation permanently attached to it to float the capsule and the driver should they be detached from the hull. It will be the responsibility of each owner to verify if his hull's flotation is adequate.
- A removable steering wheel is required with a 360 degree spring loaded release collar.

It is highly recommended, but not mandatory:

- To assist rescue crews, reinforced cockpit boats must have the following critical information labeled on the bottom of the cockpit, using 3" letters on a strongly contrasting background:
- Boat letter and number designation.
- Restraint belt - If using lever type (latch & link), do not put anything;
If using rotary type, put rotary.
If air system is used, put air.
If head restraint is used, put head restraint.

3.12.6 Boats with reinforced cockpits and full coverage canopies must have:

- Positive air flow ventilation.
- Internal and external release capability.

3.12.7 Right and left hand rear view mirrors are required on all boats with reinforced cockpits except Jersey Speed Skiff hulls with roll cage type reinforced cockpits.

3.12.8 It is strongly recommended that all inboard boats with engine cowling and/or canopies have these affixed to the boat in such a manner as to allow the removal by Rescue or Fire personnel without the use of any tools. These should be installed with external hinges equipped with quick release hinge pins.

3.12.9 Complete guidelines for construction of all Restraint Capsules are available from the Inboard Office.

3.12.10 A manufacturer of Restraint Capsules must submit his name (company name) and a completed APBA Restraint Capsule Questionnaire (available from Inboard Office) before his cockpit will be allowed in an APBA sanctioned event. Individuals building cockpits for only themselves, are still considered manufacturers and must follow the rules established for all manufacturers. All boats must have the official APBA Inboard manufacturer's label permanently attached and visible inside the cockpit. It is the boat owner's responsibility that this label be present and legible.

3.12.11 Manufacturers will receive an acknowledgement from the Inboard Racing Commission stating that the company is registered to build restraint capsules for the Inboard Category.

3.13 RESTRAINT SYSTEMS - General: To the degree practical, the seating system, whether upright or reclining, should provide lateral support on both left and right sides. The driver should be positioned as far rearward and as close to the seat back bulkhead as possible. It is absolutely necessary, in the reclining position, to provide a kick-up (roll-up) forward to the buttocks of sufficient height and strength to prevent forward movement and/or rotation of the torso under the seat belt. Closed cell padding (recommend SFI certified 45.1) is recommended under the buttocks to absorb impact.

3.14 DRIVER RESTRAINT SYSTEM: The use of an SFI certified 16.1, 16.5, 16.6, or FIA 8853-2016 certified competition driver restraint system is mandatory. Polyester belt material is recommended. Clasp, belt (strap), adjustment hardware, and system mounting condition is subject to inspection. The inspector has the right to declare a restraint system unsuitable for use. Removal or alteration of the manufacturer date tag shall result in immediate removal from service of that restraint assembly.

- **MINIMUM REQUIREMENT:** Restraint system shall consist of a two-piece (left side, right side) lap belt, two individually mounted shoulder belts, and an anti-submarine (crotch) belt connecting at a quick opening metal clasp (five mounting point). Systems using a dual crotch strap (six mounting point) or triple crotch strap (seven mounting point) are acceptable.
- Restraint system shall be mounted per manufacturer installation instructions.
- Belt material length to mounting point shall be as short as practical.
- A highly visible lanyard must be attached to the release lever of a lever/latch type system. Cam Lock (Rotary) type system shall have no lanyard attached to the actuating lever or knob.

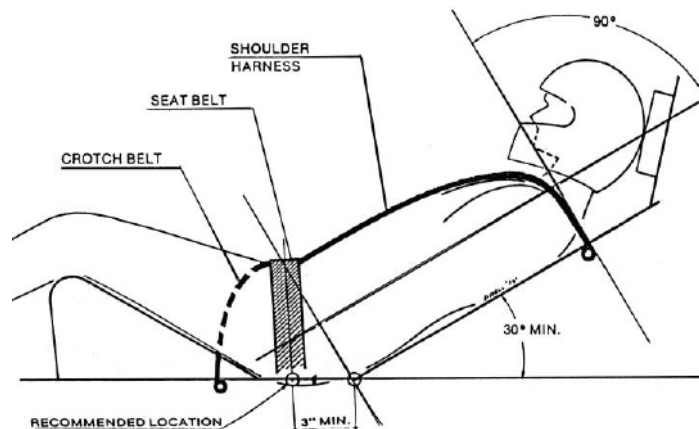

RULE 4 - RESCUE SAFETY TEAM CRITERIA

The following are the standards for rescue safety teams working APBA Inboard events.

4.1 The name of the safety/rescue team selected to work each event must be listed on the race circular for all Inboard events.

- 4.2 *Rescue personnel shall contact potential receiving hospitals prior to the event day in order to familiarize the facility with particulars about the event.*
- 4.3 *The ambulance, emergency medical staff, and dive team and all rescue team members in attendance shall be dedicated to provide service to the race for the duration of the event, and will not be on call or otherwise responsible for other duties.*
- 4.4 *The rescue team must have communication equipment sufficient to ensure adequate communication between rescue boats, race officials and the Race Rescue Director. The rescue boats shall have radio communications with the Referee, or his designee. Radio communications specific to patient condition shall be kept at a minimum. Rescuers should bear in mind at all times that radio frequencies may be monitored. Condition of patient shall only be discussed with the Referee.*

4.5 Personnel and Staffing

- 4.5.1 *An individual member of the rescue team must be clearly identified as the Race Rescue Director. He or his designee shall be the lead person at all rescue scenes and shall direct all rescue operations. He will take direction from and report to the Referee. The Race Rescue Director shall meet daily with the Referee or his designee for instruction prior to beginning the day's events. The Race Rescue Director shall immediately advise the Referee if, in his/her opinion, any unsafe course conditions (including swimmers in the water, alcohol consumption on the course boats, underage children on course boats, lack of PFD use, debris on course, etc.) exist.*
- 4.5.2 *No heat shall be started at an Inboard Regatta in the absence of a properly equipped ambulance and a licensed physician, registered nurse, paramedic, or an EMT in attendance. The ambulance will be authorized to transport injured individuals from the race course to the assigned hospital, and the medical attendant will be trained and authorized to use all the equipment in the ambulance.*
- 4.5.3 *At race events where there are classes with restrained drivers, there shall be a minimum of four divers certified by an accredited certifying agency present on the water at all times. Prior to each race day, divers shall familiarize themselves with driver safety equipment and structural characteristics of each boat. Divers shall be fully suited and ready to enter water at any time a race boat is present on the water. The divers may or may not be on the official rescue boat but cannot be on either of the turn judge boats. At race events where there are no classes with restrained drivers, the number of divers can be reduced to two (one in each rescue boat) and are required to have a current American Red Cross Basic Water Rescue Certification or equivalent or are certified by an accredited diver certifying agency. At time trial events the diver requirements may be reduced to two.*
- 4.5.5 *If Personal Watercraft are used with a diver for rescue purposes, then the Personal Watercraft MUST remain in the safety zones at either end of the course until the race boats have cleared the one minute pin. At this point they may idle to the center of the course for the duration of the heat. This will allow them to respond in any direction to assist the rescue boats stationed in either turn. Divers placed on Personal Watercraft shall carry a minimum of a 30 cubic foot Super Pony Bottle and shall be fully suited and ready to enter the water any time race boats are on the course.*

4.6 Patrol Boats and Rescue Boats

- 4.6.1 *There must be a minimum of two (2) designated rescue boats capable of carrying one or more accident victims in a supine position present and the craft shall be staffed and ready for use at all times when racing boats are under power. A patrol boat, properly staffed and equipped, may be used as a rescue boat. These boats should be positioned to minimize response time to an incident on the course.*
- 4.6.2 *All rescue/patrol/turn judge personnel shall meet with the referee, or his designated representative, for instructions prior to each day's racing.*
- 4.6.3 *The operators and crews of all rescue/patrol/turn judge boats must wear personal flotation devices (PFDs) in the manner intended by the manufacturer, any time a race boat or their rescue boat is under power on the course. They must be fully informed by the referee, or his designee, in signal flag use, driver hand signals, on how to conduct themselves, their position on the course, what to watch for, and how to respond in the case of an emergency. The importance of moving slowly to not create a wake should be stressed.*
- 4.6.4 *A set of appropriate signal flags should be carried by both rescue and patrol boats. The referee should ensure that all boat personnel are instructed in signal flag use.*
- 4.6.5 *Two patrol boats as an absolute minimum, and more if conditions warrant, are available for duty on the course at all times. Only authorized personnel shall man safety and/or patrol boats.*
- 4.6.6 *No person less than fourteen (14) years of age, unless accompanied by a parent, will be allowed to be a member of a patrol or turn judge crew except APBA members being trained or functioning as a turn judge.*
- 4.6.7 *Rescue boats may not be utilized for purposes other than rescue functions while race boats are on the water.*
- 4.6.8 *When any race boat is on the course, each rescue boat staff shall consist of a minimum of two persons on board consisting of at least one person with an American Red Cross Basic Water Rescue Certification or equivalent, capable of providing basic life support and one experienced boat operator.*
- 4.6.9 *Rescue boats should not have excessive personnel on board during the race. The number of individuals should be limited to only the number required to carry out the assigned functions. No person less than eighteen (18) years of age will be allowed to be a rescue crew member or present on a rescue boat.*
- 4.6.10 *Rescue boats shall be operated in such a manner as to avoid creating wakes except under emergency response conditions. Rescue personnel shall not offer mechanical assistance of any type to a driver. The boat operator has full responsibility for the safe operation of the craft at all times. The safety of rescuers and racers is his or her responsibility. The operator should be aware at all times of potential hazards in the water, including racers and divers.*
- 4.6.11 *The rescue boat crew shall lift all accident victims from the water in as nearly a horizontal position as possible on a Stokes, or backboard type litter. Speed of transport of a patient to onshore care should be determined in concert with the medical/rescue person in charge of the patient.*

4.7 Rescue Equipment

4.7.1 Minimum rescue/extrication equipment:

- Belt cutters or knives - with each diver.
- Octopus or other manifold air delivery device equipped with a standardized quick connect device (i.e: Tiger Performance T-1610) approved by APBA Inboard - with each diver.

- Basic Scuba Equipment with a minimum 40 cu. ft. tank for boat operations and a minimum 30 cu. ft. tank required for Personal Watercraft operations.
- Prying tool (minimum 12 inch) - one per rescue boat.
- 16-inch cable cutter - one per rescue boat.
- Rigid body immobilization device (such as Stokes basket, backboard, etc.) - one per rescue boat.
- A minimum of 25 to 50 foot tow rope with heavy duty quick connects such as snap hooks or carabiners at each end, per rescue boat.
- Equivalent of 20 lb. dry chemical (ABC) fire extinguisher - per rescue boat.
- Flares or pyrotechnic devices shall not be carried on rescue boats.

4.7.2 Medical Equipment per boat

- Body substance isolation devices.
- Airway kit including basic airway adjuncts, a bag-valve mask, and manual or mechanical suction.
- Basic BLS trauma kit.
- Blankets and towels.
- Liquid detergent for hand washing and fuel decontamination.

RULE 5 - REGATTA SAFETY

- 5.1** Each trailer or cradle will be equipped with a dry charge fire extinguisher which:
- shall have a minimum rating of 3A40BC, and a gauge indicating condition of charge,
 - shall be painted with the in-service date of the fire extinguisher and be replaced no later than five (5) years from this date,
 - shall be readily accessible for each boat in the pit area.
- 5.2** *Engines shall not be run or turned over on the beach or trailer, unless the propeller is disengaged or removed from the propeller shaft. Violators will be automatically suspended for a period of thirty days.*
- 5.3** *The areas in which the cranes are located shall be separated from all other pit areas. Access to the crane area shall be restricted and limited to authorized personnel.*
- 5.4** *With regard to weather conditions, racing shall take place at the Referee's discretion.*
- 5.5** *If, during competition or testing, a driver appears to need medical assistance or rescue services, the Turn Judge or Safety & Rescue Team must signal the Referee to stop the race.*
- 5.6** The race shall be halted and restarted in the event of a flip or a driver being thrown from or bailing out of his boat (fire, etc.). The referee shall have the privilege of stopping the race at any time when the safety of a driver is at stake. If the race is stopped after the lead boat has begun its final lap, the position of finish will be scored on the position of the boat completing the previous lap. The boat(s) causing the stoppage of the heat shall not receive points for that heat, nor be allowed to run in a restart should one take place.
- 5.7** *All persons wishing to fly any aircraft over a race course in which power boats are competing shall obtain prior approval from the Referee and be briefed as to any rules that may be imposed.*

RULE 6 - MANAGEMENT

All Inboard racing will be under the supervision of the Inboard Race Chairman and an Inboard Racing Commission elected annually as per APBA By-Laws.

- 6.1** *All races and all boats taking part therein shall be under the control and direction of a Race Committee, consisting of a Race Director, Timer, Scorer, Starter, and Inspector, all of whom shall be current members of the APBA. Matters shall be subject to its approval and control, and all questions and disputes that may arise shall be decided by it. Its decision may be overruled by the Referee, from whose ruling an appeal may be carried to the Inboard Racing Commission.*
- 6.2** *No member of any Race Committee nor the Referee shall take part in the decision of any question in which he is directly interested.*
- 6.3** **Referee:** *At all sanctioned events a Referee and Assistant Referee, selected from the list of approved Referees, shall be present. The Referee is the bona fide representative of the Inboard Racing Commission, with all personnel connected with the regatta, officials, drivers, mechanics, and owners to be under his/her jurisdiction during the entire regatta.*
- 6.3.1** *All referees must have completed and passed a yearly Referee test before being approved to work an event.*
- 6.3.2** *The Inboard Racing Commission shall appoint a number of persons qualified to act as Referees, who shall serve during the racing year of their appointment, only after passing the Inboard Referee test for that year.*
- 6.3.3** *In case of an emergency, any member of the Inboard Racing Commission may designate a Referee for any Inboard regatta.*
- 6.3.4** *No specific duties shall be assigned to the Referee such as Announcer, Timer, Surveyor, Inspector, etc. He shall not act as a member of the Race Committee or any other committee in connection with the race or regatta. He shall advise the Race Committee or make suggestions for the proper handling of the race. His suggestions to the Race Committee as to course, conduct, inspection, and compliance with rules, etc. must be observed.*
- 6.3.5** *The Referee shall be the Chief Representative of APBA at APBA events and shall have broad authority, including but not limited to the following:*
- *To serve as the Risk Manager and make sure that the event is in full compliance with all APBA rules and requirements.*
 - *To have in his/her possession a copy of the insurance certificate before any boats are allowed on the race course.*
 - *To see that the INSURANCE WAIVER and RELEASE FORMS are being signed by all PARTICIPANTS.*
 - *To attend the Drivers' Meeting and to assure himself that all questions regarding rules, conduct of the regatta, and conditions of awarding of posted prizes are thoroughly explained to all contestants. The Referee should also inform the drivers whether or not all requirements for sanction have been provided for.*
 - *To see that adequate pit facilities, pit security, and course patrols are provided for the efficient conduct of the race before the*

sanctioned testing or racing activity, (competition, testing, exhibition) begins. The Referee/Risk Manager (or his/her designee) or Race Director shall visually verify by on water personal inspection that the race course setup adheres to plan(s) on the approved insurance application and to all APBA rules prior to beginning racing activities (competition, testing, exhibition).

- To be on the Judges' Stand at all times during the running of a heat. He/she must make sure the timing, scoring, and all other details or procedure are properly handled and correctly recorded on standard forms. Should the Referee have to leave the Judges' Stand for any reason, the race or heat is to STOP, until he/she returns, unless an assistant or alternate Referee is present. The assistant Referee or alternate Referee will then take over as the Referee with all authority until he/she returns.
- To insist that all provisions of the racing rules be complied with at all times by contestants and officials.
- To ensure that all proper officials are present and functioning during the conduct of the regatta. The Referee should be on the alert to see that officials themselves obey all rules and impartially compel obedience by others.
- To remove any official or assistant at any time who in the opinion of the Referee, fails to perform satisfactorily.
- To work with Race Committee in modifying the race course as may be deemed necessary to assure the safety of drivers and spectators;
- To prohibit use of any equipment he deems unfit for service.
- To enforce the conditions demanded for a proper basis for records. He may decline to allow a speed made to be considered as a record, if in his judgment, the rules have not been complied with or enforced.
- To postpone any competition for reasons of safety or forces beyond the control of APBA and/or the organizer.
- To close the race course if any hazardous conditions exist (rough water, wind conditions, etc.), or to stop the race at any time when the safety of a driver is at stake.
- To record a disqualification on a specific member's card whenever:
 - A driver does not report with his boat to the Inspector after a race for inspection,
 - refuses to dismantle his engine when asked to by the Inspector, or
 - forfeits a race rather than submit to inspection.
 - In the opinion of the Inspector, the driver has defied the rule and competed with illegal equipment.
 - In case of infractions of any technical rules during a heat, the driver shall be disqualified from that heat and all other heats of the race.

6.3.6 It shall be mandatory that the Referee notify the owner and/or the driver as soon as possible of any disqualifications.

6.3.7 The Referee shall forward to the National Headquarters of APBA, as soon as feasible after an event, a report which shall include at least the following information:

- Incident (accident) report forms, following all instructions contained in the current form. This does not preempt local authorities from reporting those accidents as required by state and federal law. Race officials will assist local authorities in completing their reports where necessary.
- Details of protest or appeals received and any decisions he/she may have rendered in connection therewith;
- Action taken or penalties imposed;
- Any other material that the Referee may deem appropriate or APBA National Headquarters may request.

6.3.8 Immediately after the conclusion of any event where a record is claimed, the Referee shall make a report on blanks provided for the purpose, and shall file two copies of the report with the sanctioning official.

6.3.9 It shall be the duty of the Referee to report in writing to APBA Chief Referee and Inboard Chairman any problems that he/she may have enforcing any rules. This report is to be done not later than eight (8) days after the final day of the sanction.

6.3.10 Expenses of the Referee shall be paid by the organization holding the sanctioned event.

6.4 Assistant Risk Manager

6.4.1 There may be more than one Assistant Risk Manager at any regatta. The Assistant Risk Managers must be members of APBA and at least 18 years old. The Assistant Risk Managers are NOT members of the Race Committee and will have NO other duties than those concerning the SAFETY of the event. The Assistant Risk Managers must work with the referee to make sure that the event is in full compliance with all APBA rules and requirements.

6.4.2 The Assistant Risk Managers will report any and all violations immediately to the Referee and have the authority to correct any violation. The Referee and Assistant Risk Managers must work together.

6.4.3 Officials who have passed the previous year's test shall be grandfathered for a period of 45 days after the new test comes out.

6.5 Timer - Scorer - Starter

6.5.1 All must be currently active members of the American Power Boat Association.

6.5.2 The scoring test will be updated every two years. Scoring candidates must take and pass the scoring test with the minimum required passing grade PRIOR to being named Scorer by the Inboard Racing Commission. Scorers who have passed the previous test shall be grandfathered for a period of 45 days after the new test comes out.

6.5.3 The Scorer shall be in charge of registration and scoring and shall be responsible for maintaining only trained qualified personnel to assist in the duties of same. Is responsible for reviewing and submitting all summary sheets, scorers/timers data sheets, original entry blanks, liability release waivers, minor releases, officials' sign-in sheets, money and any other registration forms used to APBA Headquarters within the specified time required.

6.5.3.1 All results should be completed using a computerized scoring system unless circumstances require otherwise.

6.5.4 Shall also assist the Referee in completing accident/incident reports.

6.5.5 Scorer is a member of the race committee.

6.5.6 Expenses of the Scorer shall be paid by the organization holding the sanctioned event.

- 6.5.7** *The Timer and Scorer shall obtain, accurately compile, and record all necessary timing and scoring information for each racing competition. The Timer and Scorer shall inform the Referee and the Starter of the standings during the course of all races. The Timer and Scorer shall provide results of the competition and other material as may be directed by the Referee as soon as possible.*
- 6.5.8** *The Starter shall function under the direct supervision of the Referee. The Starter is responsible for bringing the boats to the starting line in the proper order before starting a race and before any restart of the race and for displaying the proper flag signals during the entire event.*
- 6.6** *Inspector: At sanctioned races an Inspector, selected from a list of approved Inspectors, shall be present. To be considered to be on the approved list, all inspectors must have completed and passed a yearly Inboard inspectors test before being approved to work an event. An Inspector approved in the prior year is eligible to work an event the following year when the regatta takes place prior, to or up to 45 days after, the official release of the current year's Inspector's test. It is highly recommended that all helpers also take this test. The Inspector shall act as a member of the Race Committee in connection with the race or regatta. He shall have power to enforce all provisions of the technical rules.*
- 6.6.1** *The Chairman of the Inboard Racing Commission shall appoint a number of persons qualified to act as Inspector who shall serve during the racing year of their appointment.*
- 6.6.2** *In case of an emergency, any member of the Inboard Racing Commission may designate an Inspector for any Inboard regatta.*
- 6.6.3** *The Inspector shall supervise the technical aspects of the competition, and may appoint a committee to assist with the following specific duties and authorities: To conduct before, during and after a competition such inspections and examinations of the equipment entered in such competitions as may be deemed necessary or appropriate to determine compliance with all supplementary regulations applicable to such competition, and to ascertain whether any potentially dangerous conduct may exist; To supervise and maintain control of the inspection areas during the course of an event; to take possession and conduct such examination of any and all equipment, to determine compliance with applicable rules and regulations at the conclusion of competition; and, to prepare and deliver to the Referee immediately following each competition any reports as may be necessary for the Referee to make during the course of the event.*
- 6.6.4** *It shall be the responsibility of the Inspector to attend the Drivers' Meeting and any meeting of the Race Committee. The Inspector shall inform the drivers on the number of finishers required in inspection after the race.*
- 6.6.5** *It shall be the duty of the Inspector to see that all provisions of the technical rules are complied with by contestants and report in writing to the Inboard Chairman.*
- 6.6.6** *Technical questions regarding the legality of a boat or motor shall be referred to the Inspector at each respective race site.*
- 6.6.7** *Motors, hulls, and other equipment subject to rules shall be inspected by the inspector and a report of any violation of rules and regulations submitted at the earliest possible moment to the Referee for action.*
- 6.6.8** *The Inspectors shall have the power after the finish of any race to order any contestant to dismantle his motor for inspection and measurement. Any contestant refusing to comply with the orders of the Inspector shall be disqualified by the Referee.*
- 6.6.9** *Each winning boat and motor and such others as may be designated by the Referee, shall be torn down, inspected, measured and weighed, when weight is a requirement. The Referee may waive inspection except at National Championship regattas or if a protest has been filed or records are claimed.*
- 6.6.10** *The Inspector shall inspect and check the boat with the same powers and requirements defined for motors. Boats in each weight-regulated class must be weighed at the Inspector's discretion. If the category requires the boat to have its own lifting bridle, it will be disqualified if the bridle is not available at weigh-in. All water must be removed from the boat prior to weigh-in.*
- 6.6.11** *The owner shall be responsible the condition of the motor and hull as raced. Errors on the part of the manufacturer, boat builder, mechanic, or previous owner shall not excuse noncompliance with the rules.*
- 6.6.12** *Whenever the Inspector has a technical disqualification he must immediately complete the APBA standard form "NOTICE OF TECHNICAL DISQUALIFICATION" and have the Referee sign the form. The Referee is to see that this completed form is given to driver or owner as soon as possible.*
- 6.6.13** *Expenses of the Inspector shall be paid by the organization holding the sanctioned event.*
- 6.6.14 Tools and equipment**
- 6.6.14.1** *It is expected that the Inspector/Race Committee/Region provide the inspection tools and equipment necessary to perform the inspection of any component within these rules.*
- 6.6.14.2** *It is the racer's responsibility to present any part for inspection to the Inspector as called out within their specific rule set.*
- 6.6.14.3** *Inspection (other than laboratory tests of fuel samples, etc.) shall be completed no later than midnight of the final day of the regatta. If, through no fault of his own, a contestant's equipment is not inspected by this deadline, the contestant will not be penalized and will receive those prizes and points to which he would have been entitled had his equipment been inspected and found to comply with class rules applicable.*
- 6.6.14.4** *Immediately after the finish of a race, contestants shall report with their boats and motors to the Inspector at such place as designated by the Race Committee. The boat and motor shall remain in the custody of the Inspector until dismissed. For the purpose of the enforcement of technical rules, the engine and boat shall be assumed to have been raced in the same condition in which it appears during post race inspection.*
- 6.6.14.5 Championships**
- 6.6.14.5.1** *At all listed events, it shall be mandatory that the first place boat of each eligible class be inspected to ensure that class rules have been met; the second and third place boats stand by. No other boat is required to stand by unless otherwise notified by the Inspector or Referee.*
- 6.6.14.5.2** *The midnight deadline shall not apply at Divisional and National Championships and where a boat has established a new record. In these cases the Referee shall be empowered to seal or impound any equipment which has not been inspected by midnight following the last heat of the regatta. Inspection of the sealed or impounded equipment which has not been inspected by midnight following the last heat of the regatta (other than laboratory tests of fuel samples, etc.) shall be completed within 24 hours of the last heat of the regatta. If, through no fault of his own, a contestant's equipment is not inspected by this deadline, the contestant will not be penalized and will receive those*

prizes and points to which he would have been entitled had his equipment been inspected and found to comply with class rules applicable.

6.6.14.5.3 Any contestant who has placed first (1st), second (2nd) or third (3rd) at a championship or series event who refuses inspection or leaves the race site or inspection area without permission from the Inspector or Referee will be disqualified, penalized \$300 and/or suspended for a period of 30 days. The same will apply at any event and/or anytime you are notified to report for inspection by the Inspector or Referee.

6.6.14.6 - Records

6.6.14.6.1 *No records shall be approved unless a Referee, appointed by the Inboard Racing Commission, is present and the boat and engine were inspected by a person approved by the Inboard Racing Commission.*

6.6.14.6.2 *Immediately after the conclusion of any event where a record is claimed, the Inspector must see that the boats and motors are inspected and make a report and shall file a copy of the report with APBA Headquarters, Inboard Racing Commission and Referee.*

6.6.14.6.3 *Hulls, motors, and fuels of Inboard Hydroplanes and Runabouts in the limited classes must be inspected completely per the respective class rules by the Inspector appointed for the regatta in the event of a claim for an APBA or UIM record.*

6.6.14.7 The following are four different acceptable methods of checking fuel. At the discretion of the Inspector, any one or all methods may be used.

6.6.14.7.1 Cerium Nitrate Reagent Testing: the purpose of this test is to determine if alcohol is present in fuel sample.

6.6.14.7.2 Water Solubility Test: the purpose of this test is to determine if water soluble additives are present in fuel sample.

6.6.14.7.3 Digatron Testing: The DT-15 and the DT-47 fuel testers are designed to detect the addition of oxidizers to a gas/oil fuel mixture. This is done by comparing the resistivity and the dielectric constant of a competitor's fuel to a known base. Fuel with oxidizers added (such as methanol, nitro, etc.) will cause the instrument to register more positive than the base. This indicates some type of additive in the competitor's fuel. When using the Digatron system a supply of Cyclohexane (C₆H₁₂) is needed, as this is the base called for by I.K.F. and W.K.A. It can be purchased from Klotz Special Formula Products 800-242-0489 and also Russell Karting 800-821-3359. To begin testing, use the following procedure: Turn the instrument on and allow it to warm up at least 15 minutes before doing any testing. This will allow the internal components to stabilize at their normal operating temperature. Attach the sensor to the instrument, insert the sensor in the Cyclohexane (C₆H₁₂) base, and adjust the instrument to read -75. (The reading is used to allow for minor variations in gasoline from one manufacture to another.) This -75 reading will be used as the zero adjustment in your testing. NOTE: When inserting the sensor in the cyclohexane and fuel samples to be tested, agitate the sensor to release any trapped air bubbles. Air trapped in the sensor can cause inaccurate readings. Draw a sample of the fuel to be tested and put it in a sample bottle. Be sure to use enough fuel to completely cover the sensor. Insert the sensor into the fuel and observe the reading on the instrument. If the reading is zero or a negative number, the fuel is legal. A reading of above zero (a positive number) indicates an illegal additive. When checking fuel at the race site, it is important that the temperature of the fuel being tested and the temperature of the cyclohexane be within about five degrees of each other. If the fuel being tested is more than five degrees hotter than the cyclohexane was at the time the instrument was zero at -75, the fuel will test more positive than it should. For testing ethanol concentrations, separate out the ethanol, measure the percentage, not greater than 25%, and then test the separated fuel with the Digatron.

Procedure:

1. In a 250ml graduated cylinder pour in 100ml of the fuel.
2. Add 100ml of water.
3. The ethanol will mix with the water, and the mixture will settle to the bottom of the cylinder.
4. Subtract 100 ml from the mixture to determine % of ethanol in the fuel (i.e. 110ml - 100ml = 10% ethanol).
5. Test the remaining fuel on top of water/ethanol mix with the Digatron.
6. The separated fuel remaining at the top of the cylinder must meet the requirements of rule 33.12.3.

6.6.14.7.4 Laboratory Test: The procedure would be as follows. The inspector is to advise the owner of the boat that his fuel is going to be sent to a lab and get two samples from the fuel system in the boat. The samples are to be collected in sealable containers with the owner and inspector initialing a label that is to be affixed to the containers. One sample is then to be sent to a lab in an "expedient manner". The second container is to be stored by the inspector in a safe, cool space until the test results are returned. A third sample may be taken if requested by the owner. It will also be put in a sealable container, signed by the owner and inspector and be kept by the owner. No official awards will be given or order of finish established until the fuel is determined to be legal or illegal. In a situation where the owner is not present, the person responsible for the boat will initial the seal (possibly requiring a third container.)

6.6.14.8 Engines operating on methanol will be allowed 5% contaminants, as long as the contaminants are not of the "power boost or oxygen bearing" category (i.e. nitro methane, nitro benzene, ether, etc.). The maximum allowable specific gravity is 0.800 at 20 degrees C (68 degrees F). Ethanol-based fuels are defined as fuels that contain ethanol amounts between 25% and 86% by volume.

6.6.14.9 Overall responsibility for all inspections conducted at a regatta is charged to the Inspector named on the race circular. No Inspector will inspect or be directly involved in the inspection of any racing equipment in which he has an interest, has manufactured or assembled.

6.6.14.10 No records, divisional champions or national champions shall be approved without the completed official inspection forms, signed by an Inboard Racing Commissioner.

6.6.14.11 The Technical Committee Chairman involved will be contacted by the Inspector and will determine the category of vio-

lations on engines and hulls.

6.6.14.12 Complete detailed fuel testing instruction will be supplied on request from the Inboard office.

6.6.14.13 *The use of the following substances are forbidden to be present in gasoline during any APBA event: Acrylonitrile, Amino-diphenyl, Aniline, Benzene, Benzidine, Beryllium compounds, Bromine compounds, Chloromethyl ether, Chlorine compounds, Ethylene oxide, Hydrazine compounds, Manganese compounds, Nitrobenzene, Nitrochlorobenzene, Nitrogen compounds, Nitrodiphenyl, Propylene oxide and Tert Butyl toluen* The penalty for a first violation will be a disqualification from the race and a two-year suspension. A second offense will result in a lifetime suspension.

6.6.14.14 Sponsors shall make prize money and trophies available upon request, not later than an hour after the final heat of the regatta to all scheduled classes except those under protest or undergoing inspection, unless a class rule and/or the race circular specifies otherwise.

6.6.15 – Inspections

6.6.15.1 Inspections: Hulls, motors, and fuels of Inboard Hydroplanes and Runabouts in the limited classes must be inspected per the respective class rules by the Inspector in the event of a Divisional or National Championship. It is further provided that any competing boat, motor or fuel may be technically inspected per the respective class rules at the discretion of the Referee.

At inspection the owner/driver must declare their fuel. It must be one of the fuels on the list as per **General Technical Rule 40.18.12**. Once declared, the inspector will use the data sheet for that particular fuel for comparison. If the sample tested does not meet the specifications on the data sheet, the fuel will be illegal.

6.6.15.2 Sponsors shall ensure that an approved Inboard Inspector is available and equipped with instruments and specifications to inspect those classes scheduled for the regatta. Where applicable the P&G may be used to determine the cubic inch measurement of an engine. Where applicable a compression ratio tester such as the KATECH Whistler Compression Ratio Tester may be used to determine the compression ratio measurement of an engine. The contestant shall be allowed a physical measurement of the engine, if so desired; in the event of a protest or record, a physical measure of displacement is required.

6.6.15.3 APBA Inboard Title Event Inspection Protocol for Eastern & Western Divisionals– All Stock classes shall receive a Level 1 inspection; however, one class shall be drawn from a hat at the driver’s meeting by the Referee and receive a Level 2 inspection. This class shall be announced after it has finished its heats of competition and has been sealed. For Summer Nationals, all Stock classes will receive a Level 2 inspection. All Modified classes will be inspected per their class rules.

Levels of Inspection:

Level 1: Any measurements or procedures the inspector chooses without removing the head/heads. Any 2-stroke engine must have the head/heads removed for a physical measurement of displacement.

Level 2: Any measurements or procedures the inspector chooses with the head/heads removed, but short of removing the short block from the hull.

Level 3: A complete inspection that may include removing the short block from the hull.

This protocol does not preclude the referee or the inspector from the right to inspect any equipment, for any reason, at any time, at any level. All levels of inspection allow the inspector discretion to choose the number of measurements or procedures he wishes to perform within the class rule set. In the case of a protest or a record being set a complete level 3 inspection is recommended.

6.6.15.4 – In the event of a technical violation, the Inspector will confiscate the relevant parts and submit a report to the IRC Chairperson. A Technical Violation Committee, composed of the Chairperson and three appointed members by the Chairperson, will review the violation and determine any additional penalties, which may include returning or destroying components, fines of up to \$1,000, and/or suspension of the owner for up to one calendar year.

6.7 RACE DIRECTOR: *The Race Director shall function as chairman of that event’s race committee. It shall be the responsibility of the Race Director to effectively organize the racing event, to implement appropriate safety measures and to provide the necessary personnel and adequate facilities as required by APBA for officials, competitors and other participants to ensure the appropriate environment for an APBA sanctioned event, and to assist APBA in the securing of entries.*

RULE 7 - SANCTIONS

7.1 Definition - An APBA Inboard-sanctioned event is an event that APBA Inboard has agreed in writing to sanction, in an applicable, fully executed Sanction Application and Agreement form that is in effect at the time of the event and that has not been canceled or rescinded by APBA Inboard. A sanction for a specific event does not obligate APBA Inboard to enter into a sanction agreement, or to issue a sanction, for any future event.

7.2 Running of Regatta - A regatta must be run in accordance with all provisions of the Association rules under the supervision of the category rules of the Association and under the direction of the Referee. A sanction for such a regatta must be obtained, the requirements for which are established by the Board of Directors. A pamphlet “Instructions for Running Regattas” may be obtained upon request to National Headquarters.

7.3 Regatta Reports and Summary Sheets - All regatta reports, summary sheets, and applications for records, etc. must be completed in all details and properly prepared and signed by the appropriate officials. The Scorer shall immediately thereafter file a full report of the regatta, to be mailed to National Headquarters bearing a postmark not later than eight (8) days after the final day of competition in the regatta. In event of a National Championship race, the time shall be extended to fifteen (15) days. Material received after this will be subject to not being considered for high point scoring, championship tabulation, or records claimed.

7.4 Sanction Fees - Each club, at the time it makes a request for a sanction, shall deposit with National Headquarters the sanction fee as from time to time established. Sanction applications received at National Headquarters less than forty-five (45) days prior to the regatta date are subject to not being accepted. Official notification for a National Championship, Divisional Championship, or North American Championship must be sent from APBA Headquarters 20 days prior to the event. If accepted, an additional fee may be assessed as a penalty. For other conditions, sanctions, and fees, contact National Headquarters.

7.5 Club Races - APBA Member clubs may schedule sanctioned club races for club members only. Drivers participating in these races must be

racers members of APBA. National Headquarters will issue sanction numbers and furnish regatta supplies, but there will be no high point scoring and no mailing of race circulars by National Headquarters for these special club races. These events must have approval of the Region Chairman concerned.

7.6 *After September 1st, no additional classes (or additional running of classes) may be added to a sanction for a race taking place*

between September 1st and November 1st.

RULE 8 - ENTRIES

- 8.1** *The entries made on the form provided by the Race Committee must be filed with the Race Committee within the time specified on the race circular. The entry shall be made on a "Standard Form Entry Blank." No entry shall be considered official until the driver and/or owner has displayed proof of his/her current APBA racing membership and club membership cards and a current physical exam certificate (or copy) or the current APBA racing membership card shows the physical expiration date.*
- 8.2** *Persons wishing to compete in an event scheduled at an APBA Inboard sanctioned regatta, being otherwise qualified, may purchase a SINGLE EVENT membership in accordance with APBA Inboard membership fee structure. Such members shall not, however, participate in Divisional, North American or National Championships. Single Event members may participate in record events but shall not be entitled to establish records. There shall be no other privileges to Single Event members.*
- 8.3** *The competitor must complete the official Entry Blank for the event in full, and submit it to the appropriate person by the deadline listed thereon. Acceptance of an entry is at the discretion of APBA and the Race Committee and may be refused.*
- 8.4** *The Race Committee may, if it considers it expedient, refuse any entry or set penalty for entries received after a specified closing date and so stated on the race circular.*
- 8.5** *If a competitor participates in an APBA Inboard-sanctioned event without having properly submitted a fully executed official Entry Blank, the competitor nevertheless is subject to all APBA Inboard Rules, Amendments, and Special Rules, as well as all statements, releases, and obligations appearing in the official Entry Blank, as if he had properly submitted a fully executed official Entry Blank.*
- 8.6** *A competitor in an APBA Inboard-sanctioned event shall have no claim for damages or recompense of any kind for any advertising, exploiting his name, picture, or the picture of his boat, or exploiting the achievements of any product used by the competitor's participation in the event.*
- 8.7** *An APBA Inboard-sanctioned event is a competitive sports event, the conduct of which is governed by APBA officials in accordance with the APBA By-Laws and Inboard Rules, as it may be amended from time to time, any Special Rules that may be published by APBA Inboard specifically for the event, and any applicable agreement to which APBA Inboard is a party. By submitting his entry application and taking part in any activity relating to the event, a competitor agrees to abide by the decisions of those officials relating to the event, except as provided in the By-Laws and Rules. Such competitors further agree that it is his obligation to inspect the racing area to determine that it is in a safe, raceable, and usable condition, and that he voluntarily assumes the risk of, and has no claim for damages against APBA Inboard, its promoters or their officers, directors, officials, agents or employees by reason of damage to either the watercraft, the driver, and/or pit crew. ALL such competitors assume full responsibility for any and all injuries sustained including death and property damages, any time they are in the racing area or en route thereto or therefrom.*
- 8.8** *Any competitor who competes in an event for which he is not eligible, while under suspension, probation, or for any other reason, shall forfeit all prize moneys and points won in the event, and shall forfeit all championship points won in previous events, and may be subject to a fine and suspension.*
- 8.9** *The Referee may cancel a heat, if fewer than three (3) boats cross the starting line, except when a previous heat in the race has been run. If a previous heat for the class has been run, any subsequent heat shall be canceled only if no boats cross the starting line.*
- 8.10** *The Referee must limit the number of boats starting in any heat to the number specified for that class. The Referee may, when limitations on certain courses so demand, to ensure good starting and the safety of contestants, further limit the number of boats starting in any heat or race. In such event, the Race Committee must run elimination heats for any class in which there are more entries than the permissible number of starters.*
- 8.11** *The final standing in any event necessitating qualifying heats will be determined in accordance with the point system outlined herein. All trophies, merchandise, and cash prizes shall be awarded according to the APBA Race Circular for that event.*

RULE 9 - BOAT REGISTRATION

- 9.1** *Application for registration of boats shall be made annually to the National Headquarters. Upon receipt of the application for a racing number, properly filled out and signed, and accompanied by the correct fees, National Headquarters will assign racing numbers and forward to the owner a membership card. This card, along with club membership card, must be presented to the Registry Clerk at every regatta. The release form on the application for membership must also be signed before any membership card will be officially issued. The assignment of a racing number in no way guarantees that the boat is qualified for any particular class.*
- 9.2** *All boats entered in a sanctioned race must be registered with National Headquarters and display a racing number in conformity with the Inboard rules for the current membership and racing year. The use of numbers that are unauthorized or not officially assigned for the current year is forbidden and such boats may not be scored or allowed prizes. Numbers not assigned in the following racing year are void.*
- 9.3** *Registrations and assignments of racing numbers become effective November 1st and are valid until the following October 31st unless rescinded or surrendered. When requested, the numbers of the previous membership year will be reassigned if the application is received prior to October 31st of the following membership year. After that date, old racing numbers will be considered null and void and duly canceled without further notice.*
- 9.4** *Numbers assigned by Inboard as special numbers for National Championship and high point winners shall be valid for the year assigned only.*
- 9.5** *When boats are sold, they must be re-registered and new numbers assigned to the new owner; except when the old owner surrenders the number and consents to a transfer to the new registrant at National Headquarters. Owners must remove racing numbers from hulls when possession is given to non-registered individuals.*
- 9.6** *All boat numbers shall be a minimum of eight (8) inches in height with a one and one-half (1-1/2) inch stroke using block style letters and numbers, in a strongly contrasting color on a vertical surface. A fifty (50) point penalty will be given if numbers are deemed illegible. Class letter identification shall be a minimum of three (3) inches in height with a three-quarter (3/4) inch stroke.*
- 9.7** *In the Inboard division, boats may have APBA annual registration in more than one class and must meet technical requirements of all classes in which they are registered.*
- 9.8** **Names of Boats** - *Any race boat may carry a boat name elected by the owner, but such name shall be subject to the approval of the Inboard Racing Commission. Lewd, suggestive, or vulgar names and/or graphics will not be permitted on race boats. Should such approval be withheld*

and until such time as the Inboard Racing Commission approval is forthcoming, that boat shall be ineligible to compete in any sanctioned Inboard event until cleared by the Inboard Racing Commission. The decision of the Commission shall be final on such matters.

RULE 10 - LICENSING AND REGISTRATION

- 10.1** Licenses or registrations must be secured annually from the APBA National Headquarters before drivers, crew members or officials may participate in an APBA sanctioned event. Licenses shall expire upon resignation of an active member, or upon termination by APBA for good cause. Any licensed competitor who resigns his license in any category of competition shall resign as an active participant in that category of competition in which such participant holds a license and shall be ineligible for an annual license as a competitor for twelve (12) months from the subject resignation.
- 10.2** Driver's Licenses shall expire on October 31 of each year. Licenses may be issued to competitors who are determined by APBA Inboard to be eligible to compete in the Inboard Division. Eligibility shall be determined upon the previous racing experience of the applicant and the applicant passing any required physical examination and obtaining written recommendation of driving ability satisfactory to APBA Inboard. In order for competitors to compete in any APBA Inboard sanctioned event, they must hold an APBA license for the Inboard Division.
- 10.3** Application for License shall be made on an approved form and filed with APBA National Headquarters.
- 10.4** Fees will be charged for licenses. No fees or part thereof shall be returned to a licensee because of a licensee's ceasing to participate in sanctioned competition regardless of the reason for such cessation.
- 10.5** An annual license issued by APBA is valid in competition only with respect to the category as indicated on the participant's application and license or registration.
- 10.6** Qualifications for licensing shall be specified by APBA Inboard and may be periodically revised and be such as to indicate ability to perform with satisfaction in a competition.

RULE 11 - DRIVER QUALIFICATIONS:

- 11.1** Inboard racing members who intend to drive racing boats and inboard riding mechanics must submit a statement of good health, certified by a licensed physician or a licensed medical assistant. The APBA Inboard Physical form is recommended. This form is available at the Inboard website www.apba.org under resources or on request from the Inboard office. Additionally, other motorsports racing physical forms, DOT, FAA or similar medical certificates are acceptable. If corrective lenses are listed on the physical form/certificate, they must be used in competition. The original or a photocopy of a current physical form/certificate with no waivers except for corrective lenses, are to be sent to APBA headquarters with membership application. If your physical expiration date is not on your APBA membership card, you are required to present your physical form/certificate at registration. Any of the above stated forms/certificates will remain current from date on said form/certificate until 12:00am of the second anniversary of the physical.
- 11.2** If an individual prefers to apply for his membership at the regatta site or if he prefers to apply for a one-day membership, the same requirements given above must be met; however, the Scorer will have the responsibility of sending the medical certificate or photocopy to APBA Headquarters with the membership application. APBA will make and keep a copy on file at headquarters and send the original back to the member with his APBA racing cards. Filing false or incorrect medical certificates shall be sufficient cause for suspension of the driver for two years from all APBA racing. Any driver found competing without a current physical shall be fined \$100.00 and shall sacrifice all points earned back to that date where a current physical can be shown. Proof shall be the responsibility of the driver.
 - 11.2.1** Canadian residents can submit proof of their CBF physical and membership forms along with their APBA application and waive the required FAA, D.O.T. or Inboard physical. Canadians who are not members of CBF must still provide an FAA, D.O.T. or Inboard medical certificate.
- 11.3** A new driver is any APBA Inboard member in good standing who has never driven a registered APBA Inboard boat in closed course competition. New drivers shall be designated "Unqualified Rookie" until all provisions of these rules have been met. After completion of these qualification requirements, a new driver shall be designated "Qualified Rookie" for the remainder of his first season.
 - 11.3.1** New drivers will be issued white paper cards with provisions on the reverse side for referees' signatures.
 - 11.3.2** New drivers must be given a written open book examination, followed by an oral review of said examination by the referee or an Inboard Commissioner. He shall show knowledge of course safety and racing rules before being approved to enter the race course. At each race during their rookie season, all new drivers and rookies shall present themselves to the referee and shall be introduced at each driver's meeting as a rookie driver.
 - 11.3.3** New drivers shall tape or paint a one inch (1") wide white cross on their helmet for a period of one calendar year. The cross shall extend from the front, up over the top of the helmet to the back rim of the helmet, and from left ear, up over the top of the helmet to the right ear. Rookie drivers in reinforced cockpits, whose helmets are not readily visible, must put the rookie "X" on the cockpit or canopy as near the driver's head as possible, without obstructing his vision. The "X" may be taped or painted on and must be at least 12" long and 1" wide on both sides of the hull in a color strongly contrasting the color behind it.
 - 11.3.4** Any 15 year old who has completed 16 heats of racing in the 1.5 litre stock class is eligible to race in the 2.5 Stock class and 1 litre modified class but must follow rules pertaining to any new driver Rule 11. Any 17 year old who has completed 40 heats of racing in the T class, 2.5 Stock (S/F), or One Litre is eligible to race in the E350 (E/H) or 2.5 Mod(A) class, but must follow rules pertaining to any new driver Rule 11. Proof of racing heats is the responsibility of the driver.
- 11.4** New drivers are considered legal starters of the class.
 - 11.4.1** A new driver shall run four heats, starting at the rear of the pack and advancing only to a position predetermined by the referee. After successfully completing the first 4-heat requirement, a new driver shall run four (4) additional heats advancing only to a position predetermined by the referee. The new driver may only start in the farthest outside position during these heats. To become fully qualified to race, the new driver must get signatures from four (4) qualified drivers in his/her class and at least one referee he/she has raced under. Any driver new to the Jersey Speed Skiff class must complete a minimum of ten (10) heats on the outside-eight heats as described above, with the remaining two heats to be run on the outside. New drivers who have successfully completed the Inboard Driving School shall run two (2) heats, starting at the rear of the pack, and advancing only to a position predetermined by the referee. After successfully completing the first 2 heat requirement, the driver shall run three (3) heats starting in the farthest outside position during these heats and advancing as predetermined by the referee.

- 11.4.2** Drivers already qualified who desire to drive in a class greater than they are currently qualified for, move from a hydroplane class to a runabout class (or vice versa), or have been inactive for more than twenty-four (24) calendar months; must re-qualify as follows:
- Must notify the Referee at the event during the Drivers meeting that they are qualifying or re-qualifying for a particular class.
 - Shall run two (2) heats starting from the farthest outside position, advancing only to a position predetermined by the referee.
 - Run an additional (2) heats in competition in the class, during which the driver showed the ability to handle the boat at competitive speeds and otherwise complies with all other driver qualifications outlined in the Inboard Racing Rules.

11.4.3 Rule 11.4.2 will be waived for veteran drivers from other race organizations who have raced in like classes in the past 24 months and have demonstrated an understanding of APBA Inboard rules to the referee or designee. It shall be driver's responsibility to show proof of that racing. Rookie drivers from other race organizations must comply with rule 11.4. Rookie heats run under other race organizations may be counted toward rookie qualification at the referee's discretion. It shall be driver's responsibility to show proof of that racing.

11.5 Injured drivers returning to competition must present a medical doctor's certification as to their physical and psychological fitness to race.

RULE 12 - CRITERIA FOR RULE CHANGE

In order for a proposed rule change to be acted upon by the Inboard Racing Commission, said proposal must be submitted using the following format:

12.1 Non-Technical Rule Changes

12.1.1 *All rule changes or proposals must be received at the Inboard Office on or before December 1 of each year. If a rule change is received after December 1st, the rule change or proposal must be submitted and supported by a member of the IRC to be added to the meeting agenda. Each proposal received will be put on the agenda for the next IRC meeting during the APBA Annual Meeting. If a racing rule change proposal is received, but could not be presented or completed during the Annual Meeting, the IRC could act and finalize said proposal after the Annual Meeting but no later than May 1. The Inboard Chairman, Chief Inspector and Class Representative shall receive copies of submitted proposals*

12.1.2 *If said rule change affects an existing rule, the existing rule including rule number, section, paragraph and page number should be copied as it now reads from the most recently available rule book. Following the existing rule, state the proposed rule with all changes incorporated into the text of the rule. If the new rule does not change an existing rule, state the location in the rule book (i.e.: new rule number, paragraph or section and page number) where the new rule would best be placed into text of the rules. Briefly summarize the reason for the rule change or new rule proposal. Explain why the proposed rule change should be incorporated into the rules.*

12.1.3 *If said rule is a technical rule specific to a single class, only active owners in the said class are eligible to submit the proposal. See rule 12.1.4 to define active owner.*

12.1.4 *Should the Inboard Chairman deem a class survey necessary, the following shall apply:*

- *All surveys will be conducted through the Inboard Office with the results available prior to the National Convention.*
- *The surveys will be sent to active owners affected pertaining to the proposed rule change. In this instance, the term "active owner" shall be construed to mean anyone who has participated in the current or prior race year.*
- *Class racing rules should be submitted through class representatives.*

12.1.5 *All rule changes must be published in Propeller and/or on the APBA Web site. All changes so published become effective at that time. A "Rule Change Notice" mailed to all affected members becomes effective thirty (30) days from date mailed.*

12.2 TECHNICAL RULE CHANGES

12.2.1 *Proposed technical rule changes may be submitted at any time to the Technical Committee or may be submitted as per Rule 12.1*

START AND FINISH - GENERAL RACING

General Racing Rules take precedence over those written by any category. Categories, when writing rules regarding a subject covered by General Racing Rules, may only add more restrictive details. These more restrictive rules will then prevail for that category.

13.1 Courses shall be laid in reasonably protected water as free from turns as practicable. The finish line shall be at the starting line. Each lap of the course shall be not less than one statute mile and not more than 1-2/3 miles and shall be subject to the approval of the Inboard Racing Commission thirty (30) days in advance. Competition records must be restricted to an approved course (1 mile, 1-1/4 miles, or 1-2/3 miles in length). The distance from the starting line to the entrance buoy of the first turn shall not be less than 1/2 the straightaway distance and it shall be the aim of the race committee to have this distance designed to be as long as possible. The exit buoy of the last turn may be used as a starting buoy.

13.2 If the race course allows, the following guidelines will be used: A safety zone will be established encompassing each turn, bordered by the turn buoy and an imaginary line drawn from the entrance to the exit buoy. Milling during the 5-minute period will not be allowed in these zones. Competitors may only enter these safety zones in the event of an emergency or an equipment malfunction. Boats with race support personnel **MUST** stay in the safety zone during the 5-minute warmup period. At this point they may idle to the center. The referee may grant exceptions based on special needs of the race course.

13.3 At all Inboard regattas a minimum of two course judges shall be required *whose duty it shall be to watch for and report violations of safety and racing rules.* Preferably, however, there should be a course judge stationed at the entrance and exit buoys of each turn. At the discretion of the Referee a turn judge may be stationed on the outside of the race course, provided he is elevated. Media/Data from race committee and referee approved equipment may be used as an aid to race officials. The use of video from a drone may be used in place of a turn judge.

13.4 To be qualified as a course judge, an individual must be knowledgeable of race rules and racing equipment; and should have had driving or officiating experience and must be a member of the American Power Boat Association. Approval of qualifications of course judges shall be the responsibility of the Referee.

13.5 Every attempt will be made to "fill" the field in all final heats. Instead of disqualification for driving and/or course rule violations, a one (1) minute penalty may be imposed at the discretion of the Referee for each infraction to all offending drivers. If the driver receives two (2) or more penalties in the heat, at the Referee's discretion, he/she may be disqualified. If no time was taken, each offending driver will be placed behind

all non-penalized drivers in the order they finished.

- 13.6 If, in the opinion of the referee and at his/her discretion, a contestant displays unsportsmanlike conduct, whether on or off the course, during the race day, that person may be disciplined, including suspension and/or fine. The minimum fine is to be \$100 and the maximum fine \$1000. The rule pertains to owners, drivers, crew, etc. All fines levied are appealable to the Inboard Racing Commission at the cost currently stated in the rule book and said cost is payable to the Inboard General Fund. The Yellow Card rule applies to on-water and off-water conduct at the race site during the sanction period.
- 13.7 *All decisions of the Referee shall be final regarding violations of starting, driving, and course rules. There will be no appeals or protests of the Referee's decision on course infraction. Appeals will be allowed only if a suspension is involved. Technical questions about the legality of a boat or engine shall be referred to the appropriate Technical Committee and the Inboard Racing Commission.*
- 13.8 If a contestant appeals a suspension (other than a technical violation), that suspension shall remain in force until a decision on the appeal has been reached by the Inboard Racing Commission. A contestant under suspension (other than a technical violation), shall give his APBA membership card to the Referee. The Referee shall forward the card to the Inboard Chairman, who will return it to the contestant at the termination of the suspension. If the suspension results from a technical violation, the contestant under suspension shall give the APBA boat registration card only, to the Referee for forwarding to the Inboard Chairman. With the Referee's permission, any member suspended for a technical violation may be allowed to enter the pit area. At the Referee's discretion, a member suspended for a technical violation may perform any duties asked of him.
- 14 Protests filed by one contestant against another shall be accompanied by a protest fee of ~~\$500-\$1000~~. If the protest is found to be valid, ~~the fee \$500~~ shall be returned to the owner or driver lodging the protest. If the protest is found to be invalid, ~~one-half of the fee \$250~~ will be given to the owner of the protested boat ~~and one-half of the fee~~ **and the remaining amount will be distributed in the following way: \$300 (Inspector), \$100 (Referee), \$100 (Scorer), and \$250** will be forwarded to the Chairman of the Inboard Racing Commission. The contestant filing a protest must be a registered participant for the regatta and be in the same class.
- 14.1 The owner of any boat found to be in technical violations which increase performance shall result in disqualification, a minimum fine of \$150, and removal of the Inboard Inspection Sticker. The violation shall be determined by the inspector. A violation which is of a non-speed advantage nature shall result in a warning and instructions to correct it for the next competition. If the violation is not corrected pursuant to the instruction, any subsequent violations shall result in a disqualification. A second disqualification within six (6) months shall result in a fine of up to \$1,000. The amount of the fine shall be determined by a three-person committee appointed by the Inboard Chairman. The owner shall be suspended from the time of notification of the fine until paid. All technical violations shall be recorded by the Referee on any forms furnished by APBA. The date and category of violations shall be indicated. Equipment in violation owned by the suspended owner is not to be raced during the period of suspension. Equipment in violation owned by a suspended owner shall not be eligible for registration by another until such time as the suspension period has terminated. If any entrant has multiple infractions at one race, it shall constitute only a single infraction; a new Inboard Inspection sticker must be obtained prior to returning to competition.
- 14.2 There shall be no restrictions on the amateur or professional status of the driver or crew. The driver or crew may be changed between heats provided the driver is qualified to drive that class and a drivers' meeting has been attended and the necessary papers have been signed.
- 14.3 No sanction shall be granted for any Inboard Race in the month of October unless the sanction application is postmarked no less than 30 days prior to the October race date.
- 14.4 The Inboard Racing Commission shall have the power to review any and all paperwork resulting from APBA Inboard class races and time trials and shall have power to correct any errors up to ninety (90) days after the event, or no later than November 15, whichever occurs first.
- 14.5 It is the sponsoring club's responsibility to obtain personnel and equipment to retrieve sunken equipment at a reasonable cost for the owner.
- 14.6 *The rules and conditions governing a regatta shall apply to all boats in such a regatta.*
- 14.7 *While on water, a competitor shall be governed by all rules, from the time of leaving the pits and until returning to the pits.*
- 14.8 *The owner of a competing boat, or his crew, shall not be allowed on the premises used and occupied as Operating Headquarters or the Judges' Stand by the Race Committee after the preparatory signal has been given until the last boat has finished the race. If requested to come to Headquarters or the Judges' Stand, said owner or crew may do so, but shall immediately depart therefrom when the matter which prompted the request has been attended to. Failure to leave said Headquarters or Judges' Stand when so requested will subject to disqualification the boat owned or operated by the party so refusing. The Race Committee may designate a drivers' representative to act as agents for all drivers in matters that come before the Race Committee and Referee.*
- 14.8.1 Audio communication (radio, etc.) from shore to driver is mandatory for all boats with a reinforced cockpit (capsule boats). A spotter or spotters in audio contact with the driver(s) shall be stationed in immediate proximity to the referee or his/her designee to facilitate direct communication with the driver(s) as directed by the referee or his/her designee.
- 13.17.2 It is mandatory that all boats not requiring audio communication (driver to shore) must have a working LITEceiver unit installed in their race boat. (Classes: JSS, SE, SA, and Crackerbox). In regions with starting line equipment that is compatible with the Accuclock system, the Accuclock may be used in place of, or in addition to, the LITEceiver.
- 13.17.3 The Referee of an event may excuse "The Spotter" from the above rule as long as they have a working LITEceiver in their boat and cleared by the referee.
- 14.9 *No owner, driver, contestant, or representative thereof shall hold any other owner, driver, contestant, or representative thereof liable for any personal injuries or damage resulting from an accident of racing occurring in a sanctioned race, except as a result of deliberate collision or other premeditated acts of unsportsmanlike nature. The question whether the act was deliberate or premeditated shall be determined by the Referee, subject to review by the Inboard Chairman.*
- 14.10 *No person who has been expelled from the Association or who is under suspension from the Inboard Racing Commission, or Inboard Chairman if applicable, shall be permitted to officiate or assist in any capacity in connection with any sanctioned regatta or race or engage in such regatta or race as a committee member, boat owner, driver, mechanic, or passenger. At regattas or races sanctioned by the Association conducted under the Association racing rules or any club that is a member of the Association, such persons shall be denied access to the race course and to any committee boat, Judges' boat, vessel, float, dock pits, or other premises under the control or supervision of the race committee or club conducting the regattas or race. No boat, or motor, or other racing equipment owned or chartered in whole or in part by such expelled persons shall be allowed on the race course or on any of the aforesaid premises. If, however, such person's terms of discipline specifically require him to provide assistance in conducting a regatta or race, such person may assist in such capacity pursuant to the terms of his discipline.*

14.11 No red articles, such as clothing, umbrellas, or placards shall be allowed in the vicinity of the starter or Judges' Stand and the patrol boat during the running of any regatta.

14.12 No person who is a member of the Association or a club belonging to the Association shall enter, compete, officiate, or in any way participate in, and no club that is a member of the Association shall supervise or conduct, any power boat regatta or race which has been declared unapproved by the Board of Directors or Inboard Racing Commission if applicable.

13.21.1 In the event of a violation of this rule, the appropriate body shall be empowered in its absolute discretion to impose any or all of the following penalties, or take such further actions as in its judgment is warranted by the circumstances:

- Revoke any sanctions that may have been granted by Association.
- Refuse to grant future sanctions.
- Refuse to recognize any record established during the regatta or race.
- Refuse to permit any points scored during such regatta or race to count toward any Association trophy, certificate, or any other objective or prize.
- Refuse to publicize such race or regatta, in any boat, contestant, or event therein in the official publication of the Association.
- Suspend any owner, driver, contestant, or official for an appropriate period from participating in any sanctioned regatta.

13.21.2 When possible, National Headquarters shall send notice to all persons on its mailing list that a particular regatta has been declared "UNAPPROVED". In an emergency, however, an announcement to the effect authorized by the Board of Directors or any member of a Racing Commission if applicable, at any regatta, shall be deemed to constitute good and sufficient notice.

14.13 Should unfavorable weather or circumstances make a postponement advisable, a regatta, race, or heat may be rerun beyond the sanction. The Race Committee, at their discretion, shall decide whether the regatta, race, or heat postponement shall be considered a new race, and hence open to all entrants or restricted to the valid entries at the time registration was closed.

RULE 14 - DRIVERS' MEETING

14.1 It is compulsory that the contestant(s) of each boat attend a Drivers' Meeting. The Referee must see to it that roll is called to verify the presence of each contestant(s). In case a contestant(s) cannot attend the Drivers' Meeting as scheduled because of very extenuating circumstances, it shall be the privilege of the Referee to permit the contestant(s) to be excused and have a private meeting. Contestant(s) will be subject to penalties for failing to attend the Drivers' Meeting.

14.2 The Race Committee may change the courses, amend the instructions and depart from the conditions set forth in the race circular provided such is announced to all affected drivers at the Drivers' Meeting or in some other manner.

14.3 The question of how many participants in each class shall be inspected, shall be left to the discretion of the Referee and the Inspector, except in those cases where the procedure is set forth in the Technical Rules for any given class. During the course of the Drivers' Meeting, it shall be the duty of the Inspector to announce how many of the boats in each class shall report to the Inspector for inspection immediately after the running of their event. The Inspector shall also state the location of inspection area.

RULE 15 - FLAGS

15.1 All signal flags shall be a minimum of two feet by two feet.

15.2 Flag signals are used to designate specific time or to give instructions to contestants. Briefly, the flags and their purposes are as follows:

- | | |
|---------------|--------------------------------------------------------------------------------------------------------------------------------------------------------|
| BLACK — | Course is closed, return to pits; do not leave pits. It is permissible to add a neon stripe for visibility. |
| RED — | STOP RACING! Be alert and watch for other signals. The discharge of red or orange smoke/aerial flares in conjunction with RED FLAGS is advised. |
| WHITE — | Time between score up signal and start; leader has started last lap. |
| GREEN — | Time between five-minute and score up signal; while race is underway except last lap. |
| BLUE/WHITE - | CAUTION: Problems on race course, continue with caution. |
| BLUE/YELLOW - | CAUTION: Problems on race course, continue with caution. |
| CHECKERED - | FINISH. |

RULE 16 - STARTING METHODS – CLOCK (SWEEP HAND OR DIGITAL) & FLAG STARTS

16.1 Clock (sweep hand or digital) or Flag Starts may be used and must be stated in the sanction application.

16.2 Clock Starts

16.2.1 **CLOCK, sweep hand type:** This starting clock may be manually or electrically operated and must not be less than 6 feet in diameter. It shall be equipped with lights or dropboards to visually inform the drivers of the passage of each minute during the five or three minute period. This clock shall also indicate by seconds, the elapsed time of the last minute before the start.

16.2.2 **CLOCK, digital type:** Clock, digital type: This starting clock is to be electrically operated and be capable of driving a minimum of two digit displays not to be less than 21 in. x 36 in. actual digit size each. These digits should be in a black or dark face display case. Each digit shall be made using lights of not less than a 75 watt incandescent bulb or lights of an equal brightness. When the clock is of an LED configuration, digits shall not be less than 12 in. x 18 in. actual digit size and shall be made using LED (light emitting diodes.) This clock shall also indicate, by seconds, the elapsed time of the last minute before the start.

16.2.3 All regattas MUST use a video recording start camera electronically synchronized with the starting clock. The camera shall be aligned with the starting line markers as a drivers' reference point. If the marker on the infield or inside of the course-end of the starting line shifts, the camera should be trained upon the point actually used by the drivers to determine the location of the startingline. If the video camera fails, the Referee can call a drivers meeting and choose to do flag starts. Video is REQUIRED to be shown to the drivers' representative, if requested, after the day of racing is completed.

16.2.4 In case of emergency, any form of substitute clock or starting method may be used, provided it is visible, accurate, and fair to all

competitors.

- 16.2.5** The start shall be final, even if there is only one legal starter. In the event there is no legal starter, the heat shall be canceled.
- 16.2.6** There shall be only one (1) start per heat, except as provided for in Inboard Safety Rule 5.6 and situations created by malfunctions of equipment and/or conditions where in the Referees' judgment of safety, accuracy or fairness of conditions of the start warrant a re-start of the heat. All boats crossing the starting line during the last thirty (30) seconds before the official start will be assessed a one (1) minute penalty. Should a time not be available, each offending driver will be placed behind all non-penalized drivers in the order they finished. In the event of a re-start, contestants who were assessed a penalty for an early start in the original start will not carry over their penalty.
- 16.2.7** *Before the start of a heat, a preparatory signal will be given and at this time a GREEN flag will be displayed at the Judges' Stand.*
- 16.2.8** All starts will use either a 5 or 4 minute starting procedure for all first heats. If racing conditions make it necessary to shorten the starting procedure for all the final heats, a 3 minute procedure will be allowed on all courses shorter than 1 2/3 mile. All 3-minute starts will be documented and filed in the race report. If the race course is altered in any way, such as a buoy replacement, etc., the starting procedure can never be less than 4 minutes.
- 16.2.9** At the drivers meeting the Referee will announce the score up time. At the predetermined score up time, the GREEN flag shall be immediately lowered and a WHITE flag will be displayed at the Judges' Stand.
- 16.2.9.1** *All boats will score up at the middle backstretch buoy at the predetermined score up time from the drivers meeting. All boats will establish their lane at the exit pin of turn two. After lanes are established, they must hold their lane until the start/finish line.*
- 16.2.9.2** *When cutting the course, you can only enter the infield from the backstretch and re-enter the course on the front stretch. This must be in one continuous arc from the backstretch to the front stretch.*
- 16.2.10** *At the exact instant when the hand of the starting clock or the digital display indicates that the final minute has elapsed, the starter shall drop the WHITE flag to indicate that the race has officially started. A starting signal may be given to call attention to the dropping of the WHITE flag.*
- 16.2.11** *During the time that the race is underway and until the final lap, the GREEN flag shall be displayed at the Judges' Stand. When the lead boat begins its final lap, the GREEN flag shall be lowered and the WHITE flag shall be displayed, signifying the start of the final lap for the lead boat.*
- 16.2.12** *In the event of a false start, the starter will display the BLACK flag signifying for all boats to return to the pits.*
- 16.2.13** *Any or all of the above flags may also be displayed in the turn judge boats and/or patrol boats on the course.*
- 16.2.14** *The above rules do not affect communication signals between patrol boats and the Judges' Stand, except that such signals must not be in conflict with the basic rules.*
- 16.2.15** *Should the start be postponed to a later time, a black flag shall be shown, and the boats shall return to the pits for instructions. Should a restart be required, only those boats which were legal starters at the time the heat was stopped will be eligible to run in the restart of that heat.*

16.3 STARTING FORMATS (All references to Championship Events is intended for Divisional and National Championship Events. All sanctions must have starting procedures being used posted on Sanction.)

- 16.3.1** Traditional Format - DAILY POINTS/COMPETE FOR LANES - The race for each class shall consist of one qualifying heat and one final heat of five (5) miles. Should the number of entries and time permit, two qualifying heats may be held. Entrants for the final heat shall be determined by position of finish in the qualifying heats unless specified on the race circular that the fastest times will be used to determine participant's qualification for the final heat. Points or possible position ties shall be determined by the least elapsed time per position of finish. At Championship events times taken from the participants' fastest qualifying heat will be used as the sole determinant in establishing participant's qualifications for the final heat. The order of final finish shall be by position in the final heat.-
- 16.3.1.2** Those entrants unable to start or finish the qualification heat shall be used by the Referee to fill the final heat field as long as they were not disqualified. In the event that two boats did not finish the qualifying heat and there is only one boat needed to fill the field, the boat that went the furthest distance in the qualifying heats will be used to fill the field.
- 16.3.1.3** A consolation heat may be run to determine additional place finishers if time and sufficient entries are available to form a heat. The winner of the consolation heat will assume the position behind the last legal boat to finish the final heat (i.e. if 8 legal boats finish the final, the consolation winner will be scored ninth place and so on through a maximum of twentieth place).
- 16.3.1.4** A "last chance heat" format may be used provided it is stated on the race circular. Classes with more entrants than the rule book or race venue allows will qualify for the final heat as follows:
- 16.3.1.4.1** *A drawing of entrants will be pulled from a hat for as many first round qualifying heats as needed. It shall be determined before the drivers meeting by the referee and race director how many spots will remain open for the final heat after the first round qualifying heats have been run (not less than two and no more than six spots).*
- 16.3.1.4.2** *After first round qualification heats have been run and the qualified entrants are determined for the final heat, the remaining entrants then will be put into a last chance heat or heats (determined by number of entrants). The final heat then will be filled with the finishing places or fastest times depending on the type of race.*
- 16.3.1.5** In lieu of the above, the following may be used as an alternative provided drivers are notified. Each boat will run a timed lap(s) alone on a closed course. Times will be tabulated and the fastest eight (8), ten (10) or twelve (12) boats as per class rules would run in a "Winner Take All" final heat. All boats competing in the timed lap(s) will receive qualifying heat points as per rule book.
- 16.3.2** Alternate Format 1: Race committees may use the following format at all non-championship events. The race shall consist of up to three qualification heats and a final, which may include a time trial with boats advancing to the final based on total points earned. Time trial points will be allocated the same as a qualification heat. Ties in positions for qualifying for the final shall be determined by least elapsed time in the qualification heats. The race committee has the option of competing or drawing for lanes. The method will be

announced at the drivers meeting. Alternate Format 1 may be used for all Inboard classes and at any Inboard regatta if stated on the race circular. National points will be awarded for the entrants' 3 Qualification heats and the final heat. This is a two-day format and will count as two days of racing when determining the best 15 days of racing toward the national points championship.

16.3.3 Assigned Lane Format

- 16.3.3.1 Race committees may use the following format at all non-record course events.
- 16.3.3.2 Lanes will be drawn for the first round of qualification heats of the event by the referee/ scorer and a witness or per series agreement as long as the series is listed on the sanction.
- 16.3.3.3 Second round qualification heats will be determined using the chart below.
- 16.3.3.4 Third round qualification heats will be based on the total number of points earned in heats 1 & 2 with the boat with highest number of points receiving the inside lane, ties in points will be broken by the fastest average time from round 1 & 2 qualification heats. In the event that no time is taken, a coin toss will determine the lanes.
- 16.3.3.5 Owners and/or Drivers may request the outside lane.
- 16.3.3.6 For Safety Purposes the Referee may require a boat to start in and maintain the outside lane through the exit of the first turn.
- 16.3.3.7 A qualification heat is considered official if all the groups of the same round qualification have run. (ex. Qualification 1A, 1B, and 1C)
- 16.3.3.8 The number of boats per qualification group is determined by the Referee.
- 16.3.3.9 Positions for the final shall be determined by the total accumulation of points from the qualification heats. The boat with highest number of points receives the inside lane. If there is a tie in total points, the boat with the fastest qualifier time will receive the inside lane. If there is a tie, a coin toss will determine which boat receives the inside lane.
- 16.3.3.10 All boats must be in their assigned lane before the entrance pin of turn 2 (end of the back stretch). In the event that a boat is not in their assigned lane, only the offending boat will receive a 1-minute penalty (ex. If the boat that is assigned lane 5 is in lane 3, they will receive a penalty, not every boat that they displace).
- 16.3.3.11 In the event that there are more boats than are allowed on the course at one time, a consolation heat may be run at the discretion of the Race Committee and Referee. The lanes will be determined by total points earned from previous qualification heats. The winner of the consolations heat will be assigned to the outermost available lane. National points are not awarded for the consolation heat.
- 16.3.3.12 National points will be awarded for the entrant's 3 Qualification heats and the final heat. This is a two-day format and will count as two days of racing when determining the best 15 days of racing toward the national points championship.
- 16.3.3.13 A series may develop their own points system to be used separate of APBA for the purposes of their series.

2 GROUPS						
	HEAT 1		HEAT 2		HEAT 3 - BASED ON POINTS EARNED IN	
LANES	HEAT 1A	HEAT 1B	HEAT 2A	HEAT 2B	HEAT 3A	HEAT 3B
1	1	2	16	15	1	2
2	3	4	13	14	3	4
3	5	6	12	11	5	6
4	7	8	9	10	7	8
5	9	10	8	7	9	10
6	11	12	5	6	11	12
7	13	14	4	3	13	14
8	15	16	1	2	15	16

3 GROUPS									
	HEAT 1			HEAT 2			HEAT 3 - BASED ON POINTS EARNED IN PREVIOUS 2 HEATS		
LANES	HEAT 1A	HEAT 1B	HEAT 1C	HEAT 2A	HEAT 2B	HEAT 2C	HEAT 3A	HEAT 3B	HEAT 3C
1	1	2	3	28	29	30	1	2	3
2	4	5	6	27	25	26	4	5	6
3	7	8	9	23	24	22	7	8	9
4	10	11	12	19	20	21	10	11	12
5	13	14	15	18	16	17	13	14	15
6	16	17	18	14	15	13	16	17	18
7	19	20	21	10	11	12	19	20	21
8	22	23	24	8	9	7	22	23	24
9	25	26	27	6	4	5	25	26	27
10	28	29	30	1	2	3	28	29	30

RULE 17 - FLAG STARTS

17.1 A drawing out of a hat shall be used to identify both qualifying heats and start lanes. Should multiple heats be unnecessary, the drawing shall identify lane only. The drawing shall be conducted at the Drivers' Meeting. Any driver (not to exceed two) requesting permission to examine the hat shall be allowed the opportunity immediately prior to the drawing. Final heat lane assignments shall be established by second drawing. The order of the draw shall be determined based on qualification times. Qualification times shall be established by the results of the qualification heat(s). The top qualifier shall have first draw for the final heat lane assignment. The second place qualifier shall have second draw for lane assignment, etc.

17.2 Flag start procedures

17.2.1 All boats form up in chosen lane and key off the outside boat (not to include outside lane assignments by officials for rookie driver, disciplinary action, etc.). They shall approach the start line at a moderate speed. The boats shall hold as close as possible to a side-by-side position. All boats form up at the exit of turn one in their chosen lanes as soon as possible and go around one time with the white flag up and all boats in line. If in the opinion of the starter, they are not lined up, the field shall make another lap and approach the line again. If not lined up, the offending boat will receive a warning and all boats will go around again. The second warning to the same boat will result in a one lap penalty for a "starting infraction". If another boat is the boat in error, he shall receive a warning and the field shall go around a third time. The third lap will result in a start and any boat offending the starting rule will be given a one lap penalty. The start shall be signified by dropping the white flag. After the start of the race, all boats shall follow the normal four (4) boat overlap rule used in Inboard racing for the remainder of the heat.

RULE 18 - START AND FINISH

- 18.1** *The start of handicap races may be in accordance with the handicap time allowance in which the Race Committee starts each boat separately, the scratch boat being last away; or all may start together, the winner being calculated at finish of the race.*
- 18.2** *Boats and participants shall be controlled by all rules after the warning or preparatory signal has been given, and until the particular boat has finished and is free and clear of the race course or has withdrawn from the race and left the course.*
- 18.3** *The starting line shall be of sufficient length to permit all starters to start abreast without interference. Both ends of the starting line shall be plainly marked, and the flagman, if any, shall be on the line, clearly visible to all contestants. All competing boats must cross the starting line between the markers indicating the official starting line and official stand.*
- 18.4** *No boat shall leave the pits after the one minute signal has been given.*
- 18.5** *The official timing of all boats in the race shall start when the bow of the first boat to make a fair start crosses the starting line except in a heat utilizing a starting clock, whereupon the race starts when the starting clock reaches zero (0). The time of finish of each boat shall be taken when the boat's bow crosses the finish line.*
- 18.6** *The finish of each heat shall be when the last boat in its class has crossed the finish line after completing the required number of laps. In the event a majority of the boats still running have crossed the finish line, the Referee shall, at his discretion, flag off the remaining boats still running, and they shall be scored according to their positions. Boats not running at the time the boats are flagged from the course shall receive no points for the heat, and any boat still running that has not crossed the finish line at said time shall not receive a time for its finish.*
- 18.7** *After crossing the finish line, a boat shall not interfere with any boat still in the race so as to affect the time of such boat at the finish.*
- 18.8** *A boat must start and finish a heat under its own power. No paddling, etc., shall be permitted.*
- 18.9** *The number of boats crossing the starting line before the lead boat has completed the first lap during the first heat of a race shall determine the number of boats starting the race. The start line shall be defined by the edge of the buoy closest to the first turn.*
- 18.10** *A boat working into position from the wrong side of the line after the first starting signal has been given, must keep clear of, and give way to, all boats in the race.*
- 18.11** *A boat shall not be allowed to start in any particular race or heat after the leading boat has completed one lap of the race course. No boat will be allowed to leave the pits after the one-minute signal. No boat other than those entered in the heat shall leave the pits after the five-minute or three minute signal.*
- 18.12** *All boats required for inspection immediately after finishing must report to the inspection area at a place designated by the Inspector.*
- 18.13** *The Referee shall have the power to annul any start and request a restart. In the event a restart is caused by a boat(s), that boat(s) will not be allowed to run in that heat.*
- 18.14** *A boat shall be disqualified that approaches the starting line at other than a right angle, or nearly so within 500 feet of the starting line. A buoy shall be located as near as possible to a point 500 feet from the starting line.*
- 18.15** *Milling around the 500-ft. buoy and the starting line shall be permitted unless specifically forbidden by the Referee and so announced at the Drivers' Meeting. All turns must be made to the left in any area while approaching the starting line and maneuvering for a start.*
- 18.16** *All motors must remain running once the boat enters the race course prior to the start of the race. If, in the opinion of the referee or turn judge, a contestant turns off (or purposely stalls) his motor to gain an advantage on the race course, he will be disqualified from the heat. If a contestant experiences motor problems or a spin that stalls the motor, and in the opinion of the referee no advantage was gained, the referee may waive the penalty at his/her discretion. All decisions (opinions) of the referee are final. Only Race Committee media/data may be used in verifying the decision (opinion).*

RULE 19 - BUOYS

- 19.1** *A buoy is any vessel, or other object, used to indicate the course.*
- 19.2** *Should any buoy be absent or moved from its proper position during a race, the Race Committee shall, if possible, replace it. If failing thus to replace a buoy, the race may be ordered rerun or not, at the option of the Race Committee.*
- 19.3** *The buoy must be so constructed as to inflict no major damage to racing craft striking said buoy.*
- 19.4** *All turning buoys and course buoys shall be passed on the driver's left-hand side unless otherwise indicated and announced at the Drivers' Meeting.*
- 19.5** *The start/finish buoys must be the same color as the buoy located nearest and immediately in front of the judge's stand and both shall be*

in contrast to all other buoys on the race course.

- 19.6** Entrance and exit buoys must be the same color and it is recommended they be in contrast to all other buoys on the race course.
- 19.7** Should different color buoys not be available, race committee may use buoys of different size, double up the buoys, etc., in order to make the starting, entrance & exit buoys, and the score up buoys different from the other buoys on the race course.
- 19.8** *It is mandatory that all race courses have outside course markers/buoys surrounding the race course; these outside markers shall visually differ (different color) from the inside course markers. The buoys shall mirror the inside markers as practicable, with a suggested minimum of three straightaway outside markers placed at approximately ¼, ½, and ¾ of the straightaway distance; the special marker for the start finish line may be one of these straightaway markers. The area beyond the outer course markers is out-of-bounds; boat re-entry to the race course is subject to APBA rule provisions and/or referee instructions.*
- 19.9** *Local race committees shall establish no ground rule which employs a man in the water or a man in a stopped boat as a course marker.*

RULE 20 - RIGHT OF WAY

- 20.1** *When two boats are approaching one another so as to involve risk of collision, one of them shall keep out of the way of the other as follows:*
- *When two boats are meeting end on, each shall alter her course to starboard.*
 - *When two boats are crossing, the one that has the other on her starboard side shall keep out of the way.*
- 20.2** *Every boat that is directed by these rules to keep out of the way of another boat shall, if the circumstances of the case allow, avoid crossing ahead of the other.*
- 20.3** *Every boat that is directed by these rules to keep out of the way of another boat shall, on approaching her, if necessary, reduce her speed, stop, or reverse.*
- 20.4** *Every boat overtaking any other shall keep out of the way of the overtaken vessel.*
- 20.5** *The lead boat must ensure that an overlap condition does not exist prior to changing lanes. Boats less than four (4) boat lengths apart, or one roostertail in the Grand Prix class, are considered “overlapped”.*
- 20.6** *A boat shall not bear out of her course more than 2 lane as to not hinder another passing boat.*
- 20.7** *In obeying and constructing these rules, due regard shall be had to all dangers of navigation and collision, and to any special circumstances that may render a departure from the above rules necessary in order to avoid immediate danger.*

RULE 21 • DISQUALIFICATIONS, YELLOW CARD SYSTEM

- 21.1** *The referee (or assistant referee) may give a yellow or red card to a driver for behavior at the race site during the sanction period.*
- 21.2** *A yellow or red card will be confirmed by the referee on the appropriate APBA form, which will be transmitted to the APBA office within three days. The cards become a permanent record at the APBA Headquarters.*
- 21.3** *A yellow or red card may be protested to the race committee. A negative response can be appealed according to APBA appeal rules.*
- 21.4** *Additionally, up to two yellow cards can be given at one time for dangerous driving, and a red card can be given for extremely dangerous driving.*
- 21.5** *All cards will remain valid through the four events (entire week/weekend) in which the driver competes following the date on which the last card was delivered. If there are no cards given during those four events, all cards expire.*
- 21.6** *A driver who has a valid red card or three valid yellow cards will lose the right to take part in the next APBA competition event (full weekend) in which he would reasonably compete, and his next championship (divisional or national championship) or race series event. Then all existing cards are removed.*
- 21.7** *All cards must be reported to the APBA office within three days of delivery to the driver.*
- 21.8** *If a driver receives a third valid yellow card or a red card and is suspended from participation, the APBA office will notify the driver’s region chairman, club commodore and category chairmen, and post the suspension notice on the APBA website.*
- 21.9** *Cards and penalties in effect extend into the following season.*
- 21.10** *Every boat must go fairly around the course without destroying, damaging, or dislodging any buoy unless forced to do so by another boat. In that event, only the offending boat will be disqualified or penalized.*
- 21.11** *The Referee may, with or without a protest, disqualify any boat, should it come to his knowledge before the awarding of prizes, that the contestant(s) has committed a breach of the rules.*
- 21.12** *A boat shall be disqualified from a heat in which it receives outside assistance.*
- 21.13** *Failure of the Race Committee, Judges, or any other official directly or indirectly connected with the handling of a race or any other details, to carry out any provisions of the rules or regulations, shall have no bearing whatsoever on the right of any contestant or upon a contestant’s duty to obey all rules.*
- 21.14** *Should any boat or owner commit a breach of the rules, which is of a minor or technical nature, and in the judgment of the Referee has had no direct effect on the relative position of the boats at the finish, the Referee shall have the power to decide whether or not such boat shall be disqualified.*
- 21.15** *Any official on the Judges’ Stand shall be relieved of his/her duties for the day if he/she coaches any driver with hand signals or in any other manner as the boats are coming up to the start.*
- 21.16** *If a boat misses a buoy, for any reason, the boat MUST return and pick up the missed buoy before continuing on to the next buoy or it will be assessed a 1-minute penalty.*

RULE 22 - PRIZES

- 22.1** *The amount of cash prizes and how it is to be divided will be specified on the race circular. Any other type of prizes will also be listed on race circular.*
- 22.2** *No prizes shall be presented for a protested event until all protests that might affect the prizes have been decided. In a sanctioned event, if any owner or driver gives notice of his intention to appeal from any decision of the Referee or Race Committee, the awarding of the prizes*

in that event shall not be made until said appeal has been decided.

- 22.3 Any Club, Race Committee or Race Commission that requests the return of any trophy, prize, or prize money, shall be required to put said demand in writing and mail it to the contestants involved by registered mail, return receipt requested, with a copy to National Headquarters for action by the Inboard Chairman if applicable.
- 22.4 Should any contestants refuse or fail to return any trophy, prize, or prize money so demanded by the Inboard Racing Commission, who shall make said demand in writing and mail to the contestant involved, by registered mail, return receipt demands, he shall be immediately suspended from all racing.

RULE 23 - POINTS SYSTEM

- 23.1 For National points, a match shall consist of **a minimum of** one (1) heat of competition, approximately five (5) miles in length. ~~There shall be no more than~~ When multiple qualification heats are run, National points shall be awarded based on the contestant's highest qualification heat finish. However, when using Alternate Format 1 or the Earned Lane Format, the entrant's three (3) qualification heats and final heat shall each be awarded National points.

23.1.1 The traditional race format shall be limited to one (1) race per class, per day, sanctioned on the same course or at the same regatta. The completion of a postponed race from the previous day may be conducted. If a previous day of racing is cancelled in its entirety, every reasonable effort shall be made to run the current day's scheduled event before attempting to conduct races cancelled from the prior day.

23.1.2 An alternate race format allowing a maximum of two (2) races per class in one day may be used; however, no more than two (2) races per class per weekend may be conducted under this format. This format cannot be used after August, and a request to use this alternate format must be submitted to the IRC sixty (60) days prior to the event.

- 23.2 A qualification heat and final heat must be run for all classes regardless of the number of entries.

- 23.3 A class is qualified for **full** national points only if a minimum of three (3) boats make a legal start in any of the heats scheduled for the class that day. ~~A class may be canceled if less than three (3) boats total make a legal start in the qualification heats.~~ **A class with less than three (3) boats will be scored accordingly:**

Qualifying heats and Regional finals: First place: 60 pts, Second place: 55 pts. Divisionals, Summer Nationals, and designated series event finals: First place: 90 pts. Second place: 85 pts. This rule change is for the 2026 Race Season Only and will be reviewed at the end of the season.

- 23.4 Overall points will be scored on the final position as follows:

23.4.1 Regional Events: Final Heat

1st.....100	6th 75	11th 50	16th40
2nd 95	7th 70	12th45	17th40
3rd..... 90	8th 65	13th40	18th40
4th 85	9th 60	14th40	19th40
5th 80	10th 55	15th 40	20th40

23.4.2 Divisionals, Summer Nationals, World Championships and designated series events:

Final Heat

1st.....150	6th113	11th 75	16th60
2nd143	7th105	12th 68	17th60
3rd.....135	8th 98	13th 60	18th60
4th128	9th 90	14th 60	19th60
5th120	10th 83	15th 60	20th60

23.4.3 Each boat that was not disqualified, finishing a qualifying heat will receive national points as follows:

1st100	4th..... 85	7th 70	10th..... 55
2nd95	5th..... 80	8th 65	11th..... 50
3rd.....90	6th..... 75	9th 60	12th..... 45

23.4.4 Each boat in a legal field that makes a legal start, even without completing either the qualifying heat or the final heat, will receive a minimum of 40 points. A disqualification in a heat will count the same as a DNS.

- 23.5 In case two or more boats have scored the same number of points for the series, thus establishing a tie, the winner shall be awarded to one of the tied boats with the least elapsed time for both heats.
- 23.6 If an entry be disqualified, the points for that heat shall be awarded to the legal boats in the corrected order of finish. If inspection reveals that a boat or motor is illegal, the entry shall be disqualified for each heat in which it raced, and the order of finish shall be corrected for each heat. Overall positions shall be obtained by adding the points from the heat after the order of finish has been corrected for each heat.
- 23.7 The owner of the boat accumulating the highest number of points with their best fifteen (15) races will be awarded No. 1 registration of that class for the following season. In the event of a tie, the boat that attends the most regattas will be the National Champion. The class letter and No. 1 (or his present racing number) may also be painted on the hull.
- 23.8 In the event that the final heat must be canceled, national high points will be awarded based on the order of finish in each qualification heat. In the event that more than one qualification heat is run, positions for national points will be determined by the least elapsed times. Summary sheets are to be clearly marked as: "Class Qualifications Heat, No. 1, 2, 3," etc., or "Class Final Heat".
- 23.9 In the event a hull that has scored APBA points is taken out of service (for any reason) and another hull earns points under the same hull racing number, the hull (or hulls) taken out of service are ineligible to earn additional points under that number unless all previously accumulated points earned are forfeited. Points earned by a boat can be transferred to another boat owned by the same contestant only if the original boat is destroyed or retired from racing during the same APBA racing year by the same owner. Points earned by a boat shall not be transferred to a new owner when the boat is sold. In the event an owner races two (2) or more boats in a class, individual boat point earnings shall not be combined for purposes of determining the National Championship.

- 23.10** In scoring a dead heat, both winners will receive 100 points for the heat. The third boat to finish will receive 90 points, the fourth boat 85 points, etc. The same system will be applied to dead heats for positions other than first place, using the appropriate number of points in each case.
- 23.11** *For the purpose of tabulating annual high points, the racing year shall be from November 1st through the following October 31st.*
- 23.12** National championships will be awarded to all classes that have a minimum of 8 active boats or scored 5,000 points cumulatively as a class during the current season. Additionally, National Championship classes must have had a legal field in a minimum of 5 APBA sanctioned race

days during the current racing season. Classes meeting these criteria will be awarded a national championship that includes all US-1 honors: US-1 decal, number 1 painted on hull, US-1 ring/trophy, Hall of Champions points, and others not specified. Classes not meeting these criteria will be awarded an Inboard Class Championship that does not include US-1 honors.

RULE 24 - ACTIVE BOATS

- 24.1** Must be a legally registered boat with APBA, must have finished at least one (1) heat of racing in the current year in a sanctioned APBA Inboard event, can only be counted once and cannot have been raced under another owner's number for that year.

RULE 25 - CHAMPIONSHIPS

World Championships, North American Championships, Eastern and Western Divisionals, Summer Nationals, and any other Championships, designated Series or Bonus Points Events approved by the IRC

- 25.1** During each racing year, there shall be one Eastern and one Western Divisional Championship. All registered boats are eligible to compete in all Divisionals.
- 25.2** During each racing year, at the discretion of the Inboard Racing Commission, appropriate Inboard Summer Nationals may be held and shall rotate geographically when possible. Consideration shall be given to trophies, prize money, facilities, course and best interest of Limited Inboard owners and drivers, but will be awarded to the most favorable bid regardless of location.
- 25.3** Summer National, Divisional Championship and series bids will be received by the Inboard Racing Commission at the annual meeting each year up to four (4) years in advance. These bids will be received by the IRC and a recommendation made to the Inboard Chairman. The Inboard Chairman may accept or refuse the recommendation and award the bid to others. The awarding of these championships will be done at the annual meeting or as soon thereafter as feasible.
- 25.3.1** All championship events must state in their bid to the IRC if they are going to use a flag start at their event. If not stated in their bid, the race site must use a clock starting procedure.
- 25.4** The Inboard Chairman shall check all sanctions of Inboard races or Inboard classes scheduled on the same date as the Inboard Divisionals or Summer Nationals for conflict. No sanction application for the same date as a Divisional Championship shall be approved if the site of the proposed race is within the same geographical division defined in 25.11. No race the same weekend as the Summer Nationals will receive National High Points. For events held on tidal waters, they must have run approximately the same dates and provide a tide chart showing the tide is not favorable a weekend before or after the Summer Nationals.
- 25.5** It is recommended that bidders for Championships include all nationwide classes.
- 25.6** It shall be the responsibility of the Inboard Chairman and Chief Inspector to ensure that an appropriate Inspector(s) are listed on the Sanction of all Championship events.
- 25.7** At all championship events, a minimum of three (3) competent scorers and maximum of six (6) will be used at the discretion of the Referee.
- 25.8** *In the event no final heat can be run and a tie exists in points and time, the fastest heat will determine the National or Divisional champion. In the case of accident or race stoppage by the Referee, the Referee at his discretion may or may not rerun the heat. In the event of a tie in points and no times were taken, the Referee may order a match race to determine the National or Divisional champion.*
- 25.9** The winner of the races shall be known as the Summer National Champion of his respective class until the next annual Championship. The Summer National Champion shall be the owner of the winning boat, not the driver.
- 25.10** Clock or flag starts may be used at any Series, Divisional, National and World Championship races. When a clock start is used at any of the above races, an electrically synchronized video camera must be used at the starting line.
- 25.11** For purposes of dividing the United States to determine a boundary line between East and West, Regions 1, 3, 4, 5, 6, and 7 shall be known as "East". Regions **8, 9, and 10** shall be known as "West".
- 25.12** Referees, Scorers and Inspectors for Inboard Championship and Series events must be selected from the list of approved officials available from the APBA Chief Referee, Chief Inspector, APBA Inboard Office and also at Inboard's and APBA's websites, www.goboatracing.net and www.apba.org; and must be approved by the Inboard Chairman before granting sanction.
- 25.13** If any boat which has qualified during the qualifications heats is unable to participate in the final heat, the Referee shall select the next boat in line from the qualification heats and permit said boat to take the place of the boat that is unable to participate. A boat that has been disqualified during the qualification heats shall not be eligible to participate in the final heat.
- 25.14** At all Summer Nationals, Divisionals and Series events a helicopter, cherry picker, or elevated platforms shall be required for Turn Judges.
- 25.15** The IRC will pay up to \$100.00 to be used for lodging for turn judges and corral person for each day when the Eastern, Western, or Summer National Championship is run.

RULE 26 - RECORDS

- 26.1** *No record shall be awarded unless the course is surveyed and approved by the APBA Chief Surveyor prior to the event in accordance with all instructions and requirements as outlined in the "Race Courses & Records" pamphlet dated 1998 available from APBA National Headquarters; the boat time, and the motors inspected by a person approved by the appropriate racing commission. No records may be set using a flag start.*
- 26.1.1** No APBA or UIM World speed records allowed in Alternate Format 1 or Earned Lane Format.
- 26.2** *All competition records shall be made over a one mile, one and one-fourth mile, or one and two-thirds mile course.*

- 26.3 *No record shall be awarded unless the new speed equals or betters the previous record speed multiplied by 1.003.*
- 26.4 *No competition record shall be awarded unless there are at least four (4) bona fide starters in the heat in which the record is claimed. There must be at least three finishers in any competition record. All competitors in that heat must conform to the requirements of the class.*
- 26.5 *Only one record shall be allowed on any one particular day for a given class. The highest speed made during a day for that particular class shall be considered a record provided the same meets all requirements.*
- 26.6 *A record shall only be awarded to a person who is an annual racing member of APBA and a club belonging to APBA.*
- 26.7 *The race circular information must include race course elevation for all course approved for records and Divisional and National Championships.*
- 26.8 *The various officials shall file the results of events involving records on the forms provided for that purpose. They must include Surveyor's Statement, Certificate of Accuracy of the Equipment, Contestant's Entry Blank, Scorer's and Timer's Sheet, Time Trial Representative's Report, and Inspector's Report.*
- 26.9 *A Certificate of Accuracy of the Scale(s) shall also be filed when weight regulated classes are involved.*
- 26.10 *A Certificate of Accuracy of Timing Equipment must contain the results of accuracy checks performed on the watches or electronic timing equipment by a qualified watchmaker or timing equipment expert within seventy-two (72) hours before and after the record event and must show a 24 hour rate error of no more than 26 seconds. For manually wound stopwatches, the rate must be determined with the stopwatches fully wound, after 5 minutes of running and after 10 minutes of running.*
- 26.11 *APBA will submit applications for new world records to UIM following approval of the application by the Inboard Racing Commission, provided that the driver or owner makes proper application for the new world record and includes the fee required to cover the cost of recording, processing and preparation of the certificates. UIM approves new records ONLY if UIM fees are paid. No records shall be eligible for UIM recognition unless the speed betters the current APBA class speed by the required factor. UIM requires that APBA transmit the application to UIM no later than four (4) weeks after the trial date for UIM classes and sixteen (16) weeks for APBA classes. Requests after this time period will not be accepted by UIM.*
- 26.12 *Any boat that betters an existing competitive or straight-away record or wins a National Championship shall be subject to inspection immediately after its performance unless entered in another event on the same program. In the latter case, the motor must be sealed by the Inspector pending subsequent inspection.*
- 26.13 *If a record is set at a joint sanction regatta, this record will be recognized by either association only if the member has registered with the respective governing bodies during the time registration is open as stated on the circular for that day.*

RULE 27 - CONDUCTING TIME TRIALS

- 27.1 *All surveys must comply with all instructions in the 2010 pamphlet "Race Course and Records" available from National Headquarters. All surveys must be approved by the Chief Surveyor in advance of the trial in conformity with the timing and procedure specified in "Race Course and Records".*
- 27.2 *The course shall be straight-away of 3280.8 feet in length for a kilometer course; 1320 feet in length for a 1/4 mile course; or, for a mile course, refer to the Speed Computation Formulas in another section of the Rule Book. (UIM recognizes a nautical mile, statute mile, and a kilometer course, but recognizes only the fastest miles per hour speed, regardless of course used.)*
- 27.3 *The course shall be surveyed by a licensed land surveyor approved by the Inboard Racing Commission, and he shall file a chart of same with distance, ranges, marks, buoys, etc., clearly indicated thereon in advance of the trials.*
- 27.4 *In order to be eligible to compete in a time trial, the boat must have first qualified by finishing 1st, 2nd, 3rd or 4th in a heat scheduled for the class in which the boat is registered and in which heat at least four of the contesting boats must have been of the class which the heat was scheduled. This qualification to compete in a time trial can be made at the same regatta where the time trials are held or at any other sanctioned regatta within the past 12 months where the boat was raced under the same measurement certificate in effect at the time for the trial.*
- 27.5 *In order to be eligible to drive a boat in a time trial, the driver must have qualified the boat as set out in above rule. This rule shall not prohibit a change of drivers or riding mechanics during a time trial, but in the event of any change in the crew, the new driver must have also qualified the boat as set out above, and the Race Committee must be notified of the change.*
- 27.6 *Any driver or riding mechanic who is to ride in the boat during a trial must sign the Release of Liability form on the entry blank before leaving the pits.*
- 27.7 *At the end of the straight-away, there shall be at least two range marks placed exactly at right angles to the length of the course. These range marks shall be used by the timers when determining the time of the start and finish.*
- 27.8 *A floating buoy is not a range mark, but can only be considered in time trial courses as a guide to the competing boat. Such buoys are not to be used in timing the boat at start and/or finish.*
- 27.9 *The timing shall be performed by the APBA-Kiekhaefer Scanner System, Region 11 Scanner Timer, Eastman ScannerTimer, Utah Speedboat Association Timing Subcommittee, Region 10 light emitting, diode triggered Kilometer Scanning Equipment and must be operated by a minimum of two qualified timers at each scanner position who are members of the APBA.*
- 27.10 *Alternative methods and equipment shall be approved by the Timing and Timing Equipment Subcommittee and shall be stated in these rules upon subsequent printing of the Rule Book. The basic components of record timing systems must include, but are not limited to, the following:*
- 27.10.1 *Two (2) manually operated scanners or photoelectric devices, which accurately activate and deactivate timers at the exact instant a contestant's boat stem enters and leaves the trial distance. Maximum error of said scanner or photoelectric devices are as specified on the Time Trial Representative's Report form.*
- 27.10.2 *A timer system, consisting of at least two (2) electronic digital stop watches, electrically activated directly by the system described in paragraph A above. In the event the two watches do not agree, the official time will be established from the watch with the least elapsed time.*
- 27.10.3 *Photo flash lights will be attached at each scanner position, to be activated by the system described in 27.10.1 above.*
- 27.11 *The test shall consist of two consecutive runs, one of which shall be made in one direction and one in the opposite direction. The boats shall be timed on each of these runs as provided above. All time shall be measured to 1/100th seconds, or better, and all times shall be recorded*

to 1/100th second. The two times, one for each direction as recorded above (26.7.B), shall be averaged and the speed computed using the appropriate Speed Computation Formula in the APBA Reference Book (In the Special Events and Agreements on the APBA web site) and recorded to 1/100th MPH.

- 27.12** *A boat shall not leave the course before the two runs are completed. Should it be necessary to refuel, this shall be done without leaving the course.*
- 27.13** *Upon request, the Inboard Racing Commission may sanction and supervise time trials for any UIM Inboard class or classes. In such cases, the UIM rules will apply.*
- 27.14** *A trial shall be defined as a set of six runs for a driver, crew, equipment, and class as described on the registration entry form. There shall be no changes made to the hull, power plant, crew, etc., during the progress of the trials, except as specifically permitted under the special time trial eligibility rule. Minor changes and adjustments shall be allowed*
- 27.15** *The start shall be "flying" and time will be taken as the stem of the boat crosses the line.*
- 27.16** *Each contesting entry will make the first-round runs in the order established by a drawing of lots preceding the Drivers' Meeting and supervised by the Referee.*
- 27.16.1** *Only one entry for each boat/driver combination per class will be allowed, and, as used in this rule, the word "entry" refers to a specific boat, driver, class combination.*
- 27.16.2** *No trading of positions between entries is permitted, except as authorized by the Referee at the Drivers' Meeting for special cases of hardship.*
- 27.16.3** *An entry will be charged with having used up two of the runs, one in each direction - whenever the order of rotation requires it to make its trial and it makes two runs, one run or none.*
- 27.16.4** *The order of rotation for the second round and all subsequent rounds are established in the following manner: Any time after an entry had completed a trial, the driver shall inform the Race Committee of his intention of participating in the next round of rotation, and his position shall be placed immediately behind the last previously committed entry in that particular round. An entry may skip as many subsequent rounds of rotation as it desires by not notifying the Race Committee of its intention to run, and it will not be charged with any runs; but if it has notified the Race Committee of its intention to run, as stated above, it will be charged with having used up to rounds when its turn is called, irrespective of whether it makes two runs, one run, or none.*
- 27.16.5** *If time permits, and at the discretion of the Race Committee, an entry having used up all of its allowed six runs may, upon payment of a full entry fee, resume its position in the order of rotation for an additional maximum six runs, three in each direction.*
- 27.17** *The Inboard Racing Commission will not approve a sanction for a Time Trial for a single boat or for certain specified boats. Any person or persons wishing to hold a trial for a certain class or classes of boats may do so, but such a time trial must be conducted by a member club of APBA in accordance with the rules for Time Trials and shall be advertised by means of a race circular mailed and/or e-mailed to all members of the classes involved no later than thirty (30) days before the event or display advertised in the Propeller no later than thirty (30) days before the event, and open to all registered boats in the class or classes to be invited. The parties conducting such an invitational time trial shall be responsible for all of the expenses of sanction and conduct of the event, and any entry fee charged to participants shall not exceed \$200 per boat. Requests for higher fees must be sent to the Race Management Committee at least 60 days prior to the date of the time trial.*
- 27.18** *The two runs of any boat shall be completed within a period of fifteen minutes, except at the discretion of the local Race Committee.*
- 27.19** *Time permitting, a boat shall have the privilege of making up to and including three consecutive two-way runs, from which shall be selected for the test the two fastest consecutive (each way) runs. Also, a boat that fails to cross the finish line in any one run shall be allowed the privilege of a restart. However, a total of only three restarts shall be allowed.*
- 27.20** *When a boat makes more than one two-way run, but leaves the course between one set of two-way runs and her next set of two-way runs, only those times shall be used that are made in any one complete two-way run.*
- 27.21** **Quarter Mile Record Trials:** *All of the above rules shall apply to Time Trials on a 1/4 mile course, in addition to the following:*
- 27.21.1** *All drivers and boats that have competed in an APBA race in the previous 12 months (must have scored points) are eligible to enter.*
- 27.21.2** **Equipment:** *Boats and motors must comply with all competition rules.*

RULE 28 - TIME TRIAL REPRESENTATIVE

- 28.1** *The Chairman of the Race Management Committee or the Chairman of the Timers and Timing Subcommittee will appoint a number of persons qualified to act as Time Trial Representatives, who shall serve during the racing year of their appointment. The Time Trial Representatives for any Time Trial shall be selected from this list.*
- 28.2** *The responsibilities of the Time Trial Representative are:*
- 28.2.1** *To observe the conduct of Time Trials, including the recording of times and their conversions to speed.*
- 28.2.2** *To advise the Referee on all aspects of the rules governing Time Trials.*
- 28.2.3** *To ascertain the proper functioning of all timing equipment before, during, and immediately after the Time Trials.*
- 28.2.4** *To submit a Time Trial Representative's Report to the Referee, with copies to the Chairman of the Racing Commission, and the Chairman of the Timing Subcommittee. This report will become part of the Referee's report and will contain approval of the timing Equipment and Timing Procedures, or any reason in detail for withholding such approval.*

RULE 29 - COMBINATION OF CLASSES

- 29.1** *Combined classes shall be allowed in closed course heat races.*
- 29.2** *The Referee may authorize the following combinations of classes only:*
- 29.2.1-1.5** *Litre Stock, 1 Litre, 2.5 Stock (Max per heat: 12) Note: The Referee may give 1.5 Litre Stock driver(s) special instructions about where to start and drive during the heat.*
- 29.2.2** *2.5 Stock, 2.5 Mod. (Max per heat: 10)*

29.2.3 2.5 Modified, E 350, National Mod, (Registered 2.5 Litre Stock "S" Boats not allowed.) Max. Field – 8 boats

29.2.4 National Mod, Grand National Hydro (Max per heat: 8) Note: Minimum weight of boat must be at least 1,525 lbs.

29.2.5 Grand National Hydro, GP (Max per heat: 8)

29.2.6 SA, SE, PS (maximum field 10 boats)

29.3 In case of combined classes, points are awarded to all classes with three (3) or more starters in each individual class.

29.4 Sanctions for special closed course heat races may be granted with the approval of the Region Chairman, the appropriate Inboard Commissioner and the Inboard Chairman. Such events need not be limited to the customary two heats of five miles each. All special conditions shall appear on the sanction application and race circular. No points will be scored by National Headquarters for closed-course races run under these special sanctions.

RULE 30 - PROTESTS

30.1 Drivers shall have the right to protest any violation of the rules from sanctioned regattas affecting their particular class.

30.2 When the alleged violation concerns the sanction or method the regatta is being conducted, said protest shall be filed within sufficient time to allow the appropriate persons to correct their error.

30.3 If the protest concerns the eligibility or legality of an entry, the protest must be filed in writing with the Referee not later than one hour after the finish of the inspection in question or not later than one hour after the finish of the last heat of racing on that day, whichever comes later. If the protest concerns the eligibility or legality of an entry, the complainant must post a fee of ~~\$200~~ **in accordance with the category rules**

RULE 31 - APPEALS

31.1 Any contestant who wishes to appeal a disqualification of a boat, motor, or suspension, may do so by filing with the Referee a written statement accompanied with the appropriate fee of \$100. The matter will then be settled by the Inboard Racing Commission and the Inboard Chairman. Under no circumstances will an appeal be entertained unless it is filed with the Referee not later than one hour after the finish of the last heat of racing of the day or within one hour of the adverse decision, whichever comes later.

31.2 The use of videotapes is not permissible in an appeal.

RULE 32 - SUSPENSION OF RULES

32.1 In sanctioned races when, on account of local conditions, special racing rules not provided by these rules, or changes in these rules are deemed necessary by the local Race Committee for a particular race, then the local Race Committee may send in writing to the President of APBA and the Chairman of the Inboard Race Commission their suggested changes, and if approved by the President in writing, via fax or by telegram, these rules may be used in the particular race in question and sanction granted.

RULE 33 - TECHNICAL COMMITTEES

Technical Committee

33.1 **Responsibility and Authority:** The Technical Committee will be responsible to produce and maintain all technical rules for engines, hulls and related hardware for all inboard classes, and will have authority to propose all said technical rules. The IRC has final approval.

33.2 Tech Committee reports directly to the IRC Chairperson. The IRC Chairperson is also a member of the Tech Committee in an administrative/supervisory capacity and as such does not vote on technical rules.

33.3 Tech Committee members (TCMs):

33.3.1 The Tech Committee shall be made up of technically competent individuals who cover all the technical parameters of the Inboard classes. The committee shall be made up of a minimum of 5 and not more than 7 members and shall include the Chief Inboard Inspector. The Tech Committee shall seek Associate Members to provide additional expertise in specific areas as the Tech Committee may deem necessary.

33.3.2 Prior to the National Meeting, the IRC Chairperson shall appoint the Chairperson for the Technical Committee. The Chairperson of the IRC and of the Technical Committee will then appoint members to serve on the committee. This committee will be in place during the two years of the IRC Chairperson. The Tech Committee will start their term upon appointment. Changes to the Committee can be made at any time by either the IRC Chairperson or the Technical Chairperson.

33.3.3 Should it be necessary to replace a TCM, the IRC Chairperson will select a candidate, and submit the individual to the IRC for approval or disapproval. The new TCM will serve for the balance of the current term.

RULE 34 - DRESS CODE & PIT PASSES

34.1 It shall be the responsibility of the boat owner to assure that all of his/her crew members are current APBA members in good standing;

34.1.1 That his/her crew are wearing uniforms at all Inboard sanctioned races. Minimum requirements for a uniform consist of a collared shirt for the owner and driver with the team racing identity. All other crew/team members must have a minimum of a T-shirt with the team racing identity. Failure to do so will result in a \$50.00 fine to the owner of the team.

34.1.2 That all of his/her crew members abide by all APBA rules and By-laws with regards to their behavior and conduct.

34.1.3 That all of his/her crew members and participants associated with his/her boat(s) have signed the Waiver and Release forms.

34.2 APBA membership cards will be honored at all APBA Inboard regattas; however, this does not mean that the membership cards are free admission to the spectator areas or social functions.

34.3 If you are not an APBA member, you may purchase a single-event pit pass for \$10.00. This is a one-time pass and is invalid after the event in which it is purchased.

34.4 When an owner of Inboard equipment registers that equipment with APBA, they shall be able to buy up to five Inboard pit passes for the sum of \$25 each. These passes can be used for any crew member at any Inboard event at which the owner has registered his equipment as long as all other APBA procedures are followed.

34.5 Committees wishing to sell admittance (spectator) passes to the pit area, must contact the Inboard Chairman to negotiate a fee.

RULE 35 - APBA GENERAL FUND BY INBOARD RACING

- 35.1 The APBA General Fund will be funded by sources listed below; and may be distributed for miscellaneous media coverage, television, sponsorship promotions and category administrative expenses.
 - 35.1.1 If the Referees, Scorers, and/or Inspectors requested by the Inboard Chairman are different than those chosen by the local Regatta Committee, this fund may be used to pay the additional costs, if any, for the officials being requested by the Inboard Chairman. This only applies to Nationals, Divisionals or Series events.
 - 35.1.2 A fee from all registered equipment owners at a rate established by the Inboard Racing Commission one (1) year prior to being effective, not to exceed \$35 per member per annum.
 - 35.1.3 Please note there is an additional fee of \$20 for all participating members, which includes the cost of their pit pass.
 - 35.1.4 Racing members, boat owners, and officials will be provided with their pit pass at no additional charge once their membership is received (and officials pass their test). Pit passes will be issued on site at each sanctioned event upon signing the insurance waiver form.
 - 35.1.5 A \$25 Promotional Fund Fee, \$5.00 of which going to the Inboard Challenge Series per entry, per event (weekend) for owner and a national registration fee for championship and series events for owner to be determined by the Inboard Racing Commission at the annual meeting.
 - 35.1.6 *Races will be awarded on a numerical basis by nation sections if at all possible.*
 East 1,3,4,5,6,7 West 8,9,10
- 35.2 If a section does not choose to bid or the IRC decides the sponsor is not qualified to undertake the event, it will move to the next national section.
 - 35.2.1 No sanction will be granted for the Summer Nationals, Divisionals or series races unless general fees as established by the IRC are submitted as called for in the rules.

RULE 36 - CONTRACTS & APPROVAL

- 36.1 All contracts must be submitted to the Inboard Chairman and to Legal Counsel for review and approval.
- 36.2 An approved contract will be signed by the Inboard Chairman and the sponsoring APBA club upon being awarded a bid for a National, Divisional or Series Championship. Said contract must include the TOTAL PRIZE MONIES (including tow monies and all cash prizes) the sponsoring club had in its bid.
- 36.3 A NON-REFUNDABLE deposit shall be made to APBA, payable as follows:
 - 36.3.1 Bids awarded at Annual Meeting prior to the event date: fifteen hundred dollar (\$1,500) deposit will be made upon signing contract.
 - 36.3.2 Bids awarded more than one year prior to the event date: a five hundred dollar (\$500) deposit will be made upon signing contract and an additional one thousand dollars (\$1,000) at the Annual Meeting prior to the event.
 - 36.3.3 A Bank Escrow Account in the name of APBA Inboard or some other means for securing the funds can be substituted for the deposit.
- 36.4 When a bid for a National, Divisional, or Series Championship is accepted by the Inboard Racing Commission and the Inboard Chairman, it is then the responsibility of the Inboard Chairman to protect the date awarded to insure the event's success.

RULE 37 - NOMINATING HALL OF CHAMPIONS CANDIDATES

- 37.1 **PURPOSE:** To elect from the inboard category a driver or drivers, who have accomplished goals above the normal during the ensuing year.
- 37.2 **GOALS OF ELECTORS:** To be eligible for spots #1 & #2, the selected driver must have a minimum of three (3) of the following items: one (1) through six (6) listed below, accumulating all the points from only one (1) national inboard racing class. For spot #3; the selected driver must have a minimum of three (3) of the following items: one (1) through six (6) listed below, accumulating points in any one or multiple national inboard racing classes (1) through six (6) listed below. If no drivers achieve the requirements listed for positions 1 and/or 2, drivers who meet the requirement in multiple classes shall be eligible for selection for these positions. A person receiving a red card should not be considered for Hall of Champions induction in the year they received this card.
 - 37.2.1 **National Champion** (based on points) 5 points
 Plus bonus as follows: One quarter (.25) point for every active boat for the present year with a maximum of 5 extra points.
 - 37.2.2 **Summer National Champion** 5 points
 plus one half (.5) point for every boat making a legal start in the Final, with a maximum of 4 extra points.
 - 37.2.3 **Eastern Division Champion** 3 points
 plus one half (.5) point for every boat making a legal start in the Final, with a maximum of 4 extra points.
 - 37.2.4 **Western Division Champion** 3 points
 plus one half (.5) point for every boat making a legal start in the Final, with a maximum of 4 extra points.
 - 37.2.5 **Break a Closed Course Record** 4 points
 Closed Course Record Points will be only counted one (1) time per course size (1 mile, 1 ¼ mile and 1 2/3 mile) per year unless the record was broken by another driver and reset all within the same year)
 - 37.2.6 **Break a Straightaway Record** 3 points
 Straightaway Records will only be counted one (1) time per distance (1/4 mile and Kilo) per year unless the record was broken by another driver and reset all within the same year.
 - 37.2.7 In event of a tie, candidate with greatest number of races will receive 1 point.
 - 37.2.8 In the event that the Inboard category only has two spots, the multiple class option will not be used.

37.3 GROUND RULES FOR HALL OF CHAMPIONS NOMINATIONS and ROOKIE OF THE YEAR NOMINATIONS:

- 37.3.1 Nominations with a resume of the nominee must be submitted in writing no later than November 15th to:
 Inboard Hall of Champions, David Shaw,
 20414 Spangler Drive, Lincoln, DE 19960
 H) 302-265-2465 C) 973-714-9785 E-Mail: instpov@yahoo.com *Copy to the Inboard Chairman*

- 37.3.2 Resumes must include records set; Summer National, Divisional and National Championships won; and contributions to the sport and APBA.
- 37.3.3 Nominees will be scored by points as listed for each accomplishment.
- 37.3.4 The award is for the driver's performance for the immediate year ONLY.
- 37.3.5 When the Inboard Hall of Champions Chairman has completed a review of the inductee(s), (2) two IRC members will be selected by the Inboard Chairman to review the nominees, then submit to the IRC for approval, prior to being submitted to the APBA Hall of Champions Committee for the National Meeting that year and announced.
- 37.3.6 The number of selected drivers will be determined at the end of each racing year, for the following year, by the APBA Hall of Champions Committee.
- 37.3.7 Classes that meet the requirements to be a National Championship class, set forth in Rule 23.12 shall be eligible for the Hall of Champions.

Conclusion: *At no time is the award to be demeaned in a manner of popularity or politics, but at all times to remain above reproach in fairness to the nominee.*

37.4 Inboard Rookie of the Year

Nominations must be submitted on this Rookie of the Year Nomination form. The form must be submitted no later than November 15.

All new drivers are eligible for nomination.

- If a racer is active for four heats or less during the race year, he or she is eligible the following year.
- Previously qualified drivers returning to inboard racing are not considered rookies.
- Drivers who have been previously qualified in another APBA category are eligible; however, preference will be given to those new to the sport.

The nominee's will be judged and winners selected based on the following criteria:

1. The nominee's accomplishments on the race course.
2. The nominee's contributions to the sport off of the race course.
3. The nominee's sportsmanship throughout the race season.
4. Recommendations from the nominee's references of racers/competitors, referees and Regional IRC member.

The Inboard Chairman will appoint the Rookie of the Year Committee Chairman, annually. The Committee will consist of up to 7 people (2 West, 2 Midwest, 2 East) and Rookie of the Year Chairman.

The nominations will be distributed to all Rookie of the Year Committee members for review and reference checks from racers/competitors, Referees and Regional IRC Member.

- The reference checks shall be done via phone along with written confirmation.
- The committee reserves the right to contact any references beyond the three provided.
- Each committee member will place a score on each nomination, after which the committee will deliberate and select winners based on the highest average score.
- Ties will be broken through deliberation of the committee and Inboard Chairman and Rookie of the Year Committee Chairman.

The Rookie of the Year Committee will submit their recommendations to the IRC for approval.

Winners will be announced by December 15th. The awards will be presented at the APBA Inboard Banquet held at the APBA National Meeting.

Awards: All Inboard Rookies will receive a Certificate. The Rookies of the Year will receive a custom embroidered jacket and will have their names etched on the Rookie of the Year trophies. (The Eastern Division trophy is displayed at the APBA National Headquarters. The Western Division trophy is displayed at the Hydroplane and Race Boat Museum in Seattle, WA.)

RULE 38 - MARK J. WEBER, IRC MERITORIOUS SERVICE AWARD CRITERIA

38.1 This presentation may be awarded annually at the APBA Annual Meeting, by the Inboard Racing Commission. No past recipients of this, the "Bob Ballinger Award," the "Tony Scartine Award" or the "Bruce Broussard Award" are eligible to be considered. This award will be based on the following criteria and point system. A nominee must have a minimum of one hundred and twenty (120) points before he/she will be considered for this award. All nominations should originate at the club level. The nominations should include the nominee's history with the APBA, emphasizing the following criteria.

National Officer (past or present).....	25 points
Council Member (past or present)	20 points
Region Chairman (past or present)	20 points
Region Officer (past or present)	15 points
Race Chairman (past or present)	15 points
Race Official (past or present).....	15 points
Club Officer (past or present).....	10 points
Honor Squadron.....	20 points
Inboard or National Chief Referee	10 points
Chief Scorer	10 points
Chief Inspector	10 points
Chairman of Inboard: Technical Committee	10 points
Safety Committee.....	10 points
Other National IRC Committees	5 points each
Inboard Racing Commission Member or Inboard Board of Governors (past or present)	20 points

38.2 Add one (1) point to the above for each year the nominee was a member of the APBA Inboard division.

38.3 Send nominations no later than November 15th to:
 APBA/IRC Meritorious Service Award, David Shaw
 20414 Spangler Drive, Lincoln, DE 19960
 H) 302-265-2465 C) 973-714-9785 E-Mail: instpov@yahoo.com

Copy to the Inboard Chairman

RULE 39 - CLASS RACING INFORMATION

39.1 HYDRO AND RUNABOUT CLASSES (NEW AS OF 2/13/2020)

CLASS	LEATE	WAGE	WAX HEAT	LENGTH	WAX LENGTH	WAX WIDTH	W/O DRIVER LBS	MINIMUM WEIGHT PER RATING	STEP 1.5 MIN WT PER LBS	STEP 2 MIN WT PER LBS	STEP 2.5 MIN WT PER LBS	
1 LITRE	Y	16*	12	13'6"			825	825 (3300)	1238 (3714)	1650 (3300)	2063	
				14'	17'6"	9'6"	825	825 (3300)	1238 (3714)	1650 (3300)	2063	
1.5 LITRE STOCK	T	13	12	13'6"		9'6"	825	825 (3300)	1238 (3714)	1650 (3300)	2063	
2.5 LITRE STOCK	S OR F	16*	12	13'6"	17'6"	9'6"	1025	1025 (4110)	1538 (4614)	2050 (4100)	2563	
2.5 LITRE STOCK As a Legal Step Up to 2.5 Mod	S OR F	16	12	13'6"	17'6"	9'6"	1025	1025 (4110)	1538 (4614)	2050 (4100)	2563	
2.5 LITRE MOD	A	18*	10	148.5 CID 13'6"	X	X	1025	1025 (4110)	1538 (4614)	2050 (4100)	2563	
				METHANOL	X	X	1125	1125 (4500)	1688 (5064)	2250 (4500)	2813	
				167 155.5 CID	X	X	1225	1225 (4900)	1838 (5514)	2450 (4900)	3063	
				16'/166 CID	X	X	1325	1325 (5300)	1988 (5964)	2650 (5300)	3313	
E350	E OR H	18*	10	16'	21'	11'	1525	1525 (6100)	2288 (6864)	3150 (6100)	3813	
							1325	1325 (5300)	1988 (5964)	2650 (5300)	3313	
NATIONAL MOD	NM	18	8	17' 155 CID			1225	1225 (4900)	1838 (5514)	2450 (4900)	3063	
				17' 166 CID			1325	1325 (5300)	1988 (5964)	2650 (5300)	3313	
				17' 246 CID			1350	1350 (5400)	2025 (6075)	2700 (5400)	3375	
				19' 308 CID			1900	1900 (7600)	2850 (8550)	3800 (7600)	4750	
				19' 368 CID			1900	1900 (7600)	2850 (8550)	3800 (7600)	4750	
				18' 368 CID	BUILT BEFORE 10/30/87		1600	1600 (6400)	2400 (7200)	3200 (6400)	4000	
GRAND NATIONAL HYDROPLANE	GNH	18	8	20'			2000	2000 (8000)	3000 (9000)	4000 (8000)	5000	
				20'	BUILT ON OR AFTER 11/1/97		2200	2000 (8000)	3000 (9000)	4000 (8000)	5500	
				20'	26'	511 CID	2500 W/O DRIVER	2000 (8000)	3000 (9000)	4000 (8000)	6250	
GRAND PRIX	GP	18	8	BY BUILT 12/31/07	BUILT 12/31/07	14.9	2700 W/O DRIVER	2700 (10800)	4050 (12150)	5400 (10800)	6750	
<u>note: max length 26" if before Jan. 2010</u>				AFTER 12/31/07	BUILT 12/31/07	14.0	2700 W/O DRIVER	2700 (10800)	4050 (12150)	5400 (10800)	6750	

CRACKER BOX	P	16	8	15'6"			1250 W/O DRY RIDE R	1250 (5000)	1875 (5625)	2500 (5000)	3125	
JERSEY SPEED SKIFF	JSS	16 DRY RIDE	8	16'		W/O DRY RIDE 6'	1650 W/O DRY RIDE R	1650 (6600)	2475 (7425)	3300 (6600)	4125	
SUPER STOCK	SS	16	12	16'		W/O DRY RIDE 6'	1950	1950 (7800)	2925 (8775)	3900 (7800)	4875	
SPORTSMAN ENTRY	SE	16		16'		W/O DRY RIDE 6'	1850	1850 (7400)	2775 (8325)	3700 (7400)	4625	
SPORTSMAN ADVANCED	SA	16	10				1850	1850 (7400)	2775 (8325)	3700 (7400)	4625	
KRR	K	21	8				2250	2250 (9000)	3375 (10125)	4500 (9000)	5625	
PRO STOCK	PS	16	10	16'	20'	6'	1950	1950 (7800)	2925 (8775)	3900 (7800)	4875	
*SEE RULE 11.3.4												

39.3 For the purpose of weighing the boats, follow the guidelines listed below.

39.3.1 *Boats shall be weighed after the completion of competition with all drain plugs and excess water in the hull removed. Except for removing the water, no changes may be made after competition and before weighing the boat.*

39.3.2 *Drivers shall also be weighed after the completed competition with all his equipment on, as used during competition.*

39.3.3 *Weight may be added to a hull to meet the above minimum weight; however, weight must be in place and securely fastened during all heats of competition.*

RULE 40 - GENERAL TECHNICAL

40.1 No form of outboard motor or outdrives (installed outboard or inboard) including any form of detachable motor either fastened to the transom or placed in a well shall be permitted.

40.2 Canards may be used on Inboard hydroplanes, provided they are no wider than the maximum dimension of the air trap. A maximum of two canards may be used. (Example: one on the starboard and one on the port side.) These canards may be adjusted from the cockpit while the hydro is in motion. These canards must be placed in the picklefork area; that is, in the first three feet from the bow and no higher or lower than six inches from the deck line. The canards must have positive stops to limit travel in case of control system failure. The safety Inspector shall have the authority and responsibility to approve or disapprove all mechanical parts and hardware used for fastening canards. Horizontal stabilizers, airfoils, or wings may be used at the rear of inboard hydroplanes provided they are no wider than the maximum beam of the hull. These stabilizers must be bolted in a fixed position if they are greater than 24 inches above the deck line, except in GP classes. In addition to canards, deck spoilers and/or flaps may be used to control lift provided they are installed within the 24 inch deck line allowance. These flaps may be adjusted from the cockpit while the hydroplane is in motion and must have positive stops in the event of a control system failure.

40.2.1 *Adjustable angle props, shaft angle, or adjustable skid fins are strictly prohibited while boat is underway.*

40.3 Any modifications or changes made to engines other than those itemized in the class technical specifications will be in violation of the class rules. If a question of interpretation arises, it must be addressed by the Technical Committee as per their guidelines; Rule 33.1. All decisions by the Technical Committee must be in writing and published in the earliest possible issue of *Propeller* and APBA/APBA Inboard Website. Any interpretations made under this authority must be included in the next printing of the rule book unless ruled out of order by vote of the Inboard Racing Commission. It shall be the responsibility of the technical committee to act on all technical matters.

40.4 All engines used in Inboard racing shall be of the reciprocation piston type.

40.5 With the Inspector present, it is permissible to change engines at all Inboard events, provided that the engine removed is submitted to the Inspector to determine its legality.

40.6 All boats which are to be lifted in or out of the water must be equipped with suitable and adequate lifting rings and gear. Such lifting rings and gear must be approved by the Inspector annually. Without such approval the boat will not be lifted by any crane or other device provided by the local Race Committee at the pits.

40.6.1 All boats must have a bow eye or other device which allows the boat to be towed in a forward direction. This must be located in an area that is easily accessible to the driver or tow boat personnel.

40.7 The class letter and racing number of each boat shall be painted on the boat trailer in letters 3 or more inches high. Where possible, the numbers shall be located within 3 feet of the trailer tongue.

40.8 No form of mechanical supercharger or other auxiliary device shall be employed to increase the compression or volumetric efficiency of cylinders, except in GP and KRR classes.

40.9 The length measurement for hydroplanes shall be the perpendicular distance between the parallel lines created from the bow or sponson tips and the aftermost edge of the bottom surface. Rudders, propellers and cavitation plates are not included in the measurements of hull length. Add-on extensions that do not conform to the original hull outlines or shape to achieve class length are prohibited. Struts, propellers and rudders must be relocated in proportion to any additions. For all classes not having a maximum hull width, the maximum hull width including turning fin and all mounting hardware shall not exceed 117% of the maximum hull width as measured by the perpendicular distance between parallel lines created from the widest part of the hull.

40.10 All Technical rules approved will become effective when published in *Propeller* and/or APBA/APBA Inboard Website (per APBA Bylaws).

40.11 Radios will be used for communications to the driver with the following restrictions: The radios must not interfere with communications of the Race Committee; they must change to another frequency or channel or the Referee shall prohibit the use of the radios that are causing interference.

40.12 A gearbox may be used as an engine-shaft coupler in the 2.5 Stock, 2.5 Mod, 1-Litre, National Mod and GNH, GP, SE, SA, PS, and KRR.

40.13 Except for the purpose of air supply to the driver/rider or the direct fuel supply to the engine; the use of onboard supplies of gases, nitrous oxide or compounds such as oxygen or compressed air, onboard and used as an engine performance enhancing product, is strictly prohibited. Class rules that allow for the use of additives or compounds, including those that are performance enhancing, will supersede this rule to the extent that those class rules allow.

40.14 The maximum of four (4) blade propellers may be used in the 1.5 Litre Stock, 2.5 Litre Stock and E 350.

40.15 Balancing of the rotating assembly is allowed; however, within the rod set at least one upper and one lower rod end must remain "as received" from the OEM—i.e.: no additional grinding, milling, or polishing is allowed. The practice of lightening rotating and reciprocating components of an engine, i.e., grinding and polishing connecting rods, further lightening the lightest rod, piston and piston pin in an effort to lighten the total assembly, is prohibited in Stock classes.

40.16 The Inboard Chief Inspector will oversee all engine rules. He can request that inspections be done at random throughout the racing season.

40.17 A participant will be allowed to run an engine /configuration that does not meet the legal requirements of a particular class as a research vehicle for possible new engine/configuration inclusion to the inboard category. The participant shall be a registered APBA member and active owner within the class and must petition the IRC to be allowed to run an alternate engine /configuration. This petition request, if approved, shall have a maximum term of two years. At the end of this 2-year term, the participant must submit a request that the engine /configuration have inclusion as a legal engine /configuration in that class or submit a request for an extension for further research.

Participants using probationary equipment will be counted as bona fide starters in the class but will not be scored. This boat will not displace any boat in an elimination situation because it receives no points but will be given every opportunity to run at the Referee's discretion. Probationary participants are not eligible for records, High Points Champion (US1), and boat will not count toward HOC criteria. Prize money and tow/show money will be awarded per the race circular.

40.18 General Technical Rules for the following Spec/Stock classes: 1.5 Litre Spec, 2.5 Litre Spec, E 350, and Jersey Speed Skiff.

- 40.18.1** The word "stock" as used in these rules is understood to mean the part in question will be used as it was supplied to the general public by the original motor manufacturer. The term "stock replacement" is understood to mean the part is sold to the public as a direct replacement for a stock part, without modification. Its marketed purpose must be for use in rebuilding an engine to stock specifications; not to increase power. The term "spec" refers to the use of aftermarket parts that comply with the specifications/rules of the individual class. No titanium parts are permitted.
- 40.18.2** All engines used in *Spec/Stock* Classes must remain stock as furnished by the manufacturers. Alterations are not permitted except as specified herein or as specified in the individual Spec/Stock class rules.
- 40.18.3** Cylinder blocks may be bored, honed, align bored, deburred and resurfaced in order to achieve the desired deck height or protrusion of the pistons. Deburring is not to be confused with grinding/polishing. Grinding and polishing to reduce weight and/or gain a performance advantage are prohibited. For the purpose of salvaging a damaged cylinder block, a maximum of four cylinders and/or a maximum of four lifter bores may be sleeved. Engines may be painted internally to enhance oil flow. External parts may be painted or chromed to enhance appearance. All unnecessary parts outside of the engine may be removed to permit installation into the boat. Oil passages may be blocked, water passages may be modified. Lifter valley baffles, stand pipe and/or screens are permitted in stock engines.
- 40.18.4** Rotating and reciprocation components of the engine may be balanced. Total assembly may not be lightened in an effort to gain added performance.
- 40.18.5** Cylinder heads may be flat milled in order to achieve allowable combustion chamber volume. Machining of valve seats and valves must meet class specifications as well as all components used in the head and valve train. Push rod length is non-inspectable but must be steel or chrome moly and stock diameter unless otherwise stated in class rules.
- 40.18.6** Carburetor choke mechanism components and air filter tie-down bars may be removed. Refer to class rules for legal part numbers of carburetors, venturi and throttle bore sizes. When a carburetor spacer is allowed under individual class rules and a maximum measurement is given, the measurement is taken to mean the maximum thickness of the compressed portion of the spacer beneath the carburetor, and/or the inside diameter of the spacer. Additional material external of the manifold and compressed portion of the spacer is allowed.
- 40.18.7** Crankshaft main bearing journals and rod journals may be reground. Stock configuration of crankshaft counterweights must be maintained in the balancing process. Knife edging and chamfering of these weights are prohibited.
- 40.18.8** Camshaft - Any aftermarket cam may be used providing it meets OEM profile consistent with class rules. Cam may be advanced or retarded.
- 40.18.9** Pistons - Any cast stock original or replacement piston available on the open market may be used. Forged pistons are allowed in certain classes; refer to class rules.
- 40.18.10** Oil pan, oil pump and oil pickup may be modified as necessary but must remain a wet sump system. Remote filter, oil cooler, and oil accumulator are permitted. One oil accumulator is permitted, connected by a single oil line.
- 40.18.11** Gaskets, spark plugs, wires, bearings, filters, fuel lines, hoses, fittings, valve covers, timing chain covers, breathers, nuts, bolts, washers, fittings and exhaust system may be of any manufacturer. Studs may be used in place of bolts.
- 40.18.12** All stock classes and classes that designate "gasoline" as a fuel without additives must use unleaded fuel corresponding to petroleum based fuel as defined by American Society for Testing and Materials (ASTM), designation: D4814, with the following clarifications.
- The specific gravity must fall within the range: .715 to .765 at 60 degrees F.
 - The maximum oxygen content is 4.0% by weight.
 - The only allowable oxygenates are ether and alcohols, as listed and characterized for oxygen mass fraction in ASTM D4814.
 - The ethanol content must be less than 25% by volume.
 - Epoxydes (i.e. propylene oxide) will not be considered ethers. Nitrogen bearing compounds are not allowed.
 - Lubrication additives are permitted, provided the resulting mixture would meet all other requirements. OR
 - APBA approved racing fuels listed below.

Manufacturer	Fuel Name	Color	Specific Gravity	*Digitron	Notes
SUNOCO	Standard	Purple	0.728	-73	
	Supreme	Blue	0.716	-87	
	HCR Plus	Orange	0.738	-81	
	Maximal	Red	0.712	-83	
	GTX260	Green	0.762	-56	
POWER MIST	T-102	Blue	0.735	-75	
	T-105	Blue	0.730	-90	
	T-111	Blue	0.718	-88	
	T-112	Blue	0.728	-84	
CITGO	110	Red	0.728	-71	No Oil
VP	C-11	Gold	0.710	-75	
	C-12	Green	0.717	-79	With Oil
	C-14	Yellow	0.696	-86	With Oil
	C-16	Blue	0.735	-97	With Oil
TRICK	114	Blue	0.720	-66	
	Turbo 119	Green	0.730	-69	
RENEGADE	HR 102	Aqua	0.720	-73.5	
	Track 110	Purple/Blue	0.721	-80.5	
	Pro 110 Plus	Purple	0.718	-86	-68?
	Pro 112 Plus	Blue	0.711	-85	
	Pro 116 Plus	Red	0.705	-88.5	
	Pro Super Late Model	Light Pink	0.724	-81.5	
	Pro R11 Plus	Red	0.688	-82	
TURBO BLUE	110	Blue	0.738	-79	

***Digitron readings are averages taken over the past several years. Two stroke fuel will test in the -65 range with no oil. More information will be given as required.**

You cannot mix any of these fuels. They must be used as per the spec sheet for the fuel that you declare.

Example 1: You cannot mix Power Mist with Sunoco.

Example 2: You cannot mix unleaded gasoline with any race fuel.

Example 3: You cannot mix VP C12 with VP C16

40.18.13 Valves: Any stock or stock replacement steel valve may be used as long as the stock stem diameter is maintained throughout (no reduced diameter, undercut stems). Face angle: 45 degrees only. Intake and exhaust head diameter tolerance +/- 0.005" unless otherwise noted. Stainless steel valves may be used. Back cutting the valve (relief angle) unless defined within the specific class rules is not permissible. Swirl, Titanium, hollow stem, or sodium filled valves are not permitted.

CLASS TECHNICAL INFORMATION

RULE 41 - 1 LITRE CLASS

41.1 Competing boats will be powered by one internal combustion piston motor which complies with one of the following descriptions:

41.1.1 Maximum displacement, including clearances: 4 cycle - 1030cc.

Fuel: gasoline or methanol. Unlimited modifications.

41.1.2 Maximum displacement, including clearances: 2 cycle - 1160cc.

Fuel: gasoline, carburetors only, only a single expansion chamber exhaust system allowed. Unlimited modifications.

41.1.3 Maximum displacement, including clearances: 4 cycle - 1260cc.

Fuel: gasoline, carburetors only. Unlimited modifications.

41.1.4 Maximum displacement, including clearances: 4 cycle - 1315cc.

Fuel: gasoline, carburetors only, 1 venturi per cylinder. Unlimited modifications.

41.1.5 Maximum displacement, including clearances: 124.7ci. Ford Pinto. Boats using this motor must conform to all the rules of the 2.5 Litre Stock Class.

41.1.6 Ford Engine 2.3 Litre with head option 2 (Cast Iron Head). Boats using this motor must conform to all the rules of the 2.5 Litre Stock Class.

41.1.7 No multi-speed or variable speed gear box, clutch or belt drive system allowed.

41.2 Blowers, superchargers and outdrives are prohibited.

41.3 No more than 1 intake and 1 exhaust valve per cylinder.

RULE 42 - 1.5 LITRE STOCK

42.1 The purpose of these rules is to promote an entry level class of Inboard hydroplane racing for drivers 13 years of age or older, who will be attracted by relatively low initial cost and economy of operation. It shall be the responsibility of the 1.5 Litre Stock Technical Committee to make technical rule recommendations pertaining to the class to the Inboard Racing Commission.

42.1.1 Competing boats will be powered by a SOHC, 4AC (1587cc) Toyota with a maximum bore including overbore of 3.238 inches and stroke of 3.03 inches. Also allowed is the 1.9 SEFI GEN II SOHC Ford engine in the 1.5 Liter Stock class. The only version allowed is the one from the Sports Car Club of America (SCCA) spec class racer 1.9 SEFI GEN II SOHC. The engine comes sealed by SCCA. The only seal(s) that may be removed by the owner are from the oil pan, and solely for the purpose of allowing the oil pan and pickup to be modified to fit the engine into the boat. Maximum ignition timing is 38 degrees base timing, measured by a timing light with adjustable advance, pointed at the cam sprocket mark at the top of the valve cover. The only propellers to be used with this engine are short-hub, 7/8 spline.

42.1.2 Recommended minimum inspection procedure for 1.5 Liter Stock Ford SOHC 1.9 L (If unsealed for repair.)

42.1.3 Procedure to check camshaft lift: Remove hydraulic lifter and install adjustable solid lifter. Rotate engine in normal direction until lifter is on the heel of the camshaft lobe. Install dial indicator to measure valve lift. Adjust valve lash until dial indicator reads .001". Set dial indicator back to zero. Rotate the engine in the normal direction until dial indicator reads .050". Install degree wheel on cam sprocket with a pointer. Set degree wheel to zero degrees (TDC) at the pointer. Rotate the engine in the normal direction and check degree wheel at every .050 of valve lift. There is a 1 degree +/- factor for rocker wear.

Option A: Asymmetrical Cam Profile

Valve Lift Thousandths Intake Angle Degrees Exhaust Angle Degrees

0.050 0° 0°

0.100 5° 5°

0.150 10° 10.5°

0.200 15° 16°

0.250 20.5° 22.5°

0.300 27.5° 30.5°

0.350 36° 40°

0.400 55° 61°

Maximum Lift 0.407 0.418

0.400 60° 65°

0.350 78° 76.5°

0.300 81.5° 86°

0.250 93° 94°

0.200 100° 100.5°

0.150 105° 106°

0.100 110° 111°

0.050 115° 116°

0 135° 129°

Option B: Symmetrical Cam Profile

Valve Lift Thousandths Intake Angle Degrees Exhaust Angle Degrees

0.050 0° 0°

0.100 5° 5°

0.150 10.5° 10.5°

0.200 16° 16°

0.250 22.5° 22.5°

0.300 30.5° 30.5°

0.350 40° 40°

0.400 61° 61°

Maximum Lift 0.418 0.418

0.400 65° 65°

0.350 76.5° 76.5°

0.300 86° 86°

0.250 94° 94°

0.200 100.5° 100.5°

0.150 106° 106°

0.100 111° 111°

0.050 116° 116°

0 129° 129°

42.1.4 Bore 3.250"

42.1.5 Stroke 3.470"

42.1.6 Cylinder head CC:

52 cc, Head Gasket Thickness .0900"

57 cc, Head Gasket Thickness .0650"

42.1.7 Intake Valve 1.660"

42.1.8 Exhaust Valve 1.460"

42.1.9 Deck height .083" above deck at center of piston at TDC.

42.1.10 Throttle body measured at outlet of throttle body 1.575"

42.2 Toyota SOHC-4A (1587cc)

- 42.2.1 Any external brackets used to support or drive accessories may be added or removed. Pulleys or belt drives may be removed. Pollution control devices may be removed and applicable holes in the motor may be plugged. Any modification to the block or head for the sole purpose of water inlet or outlet (cooling of motor) is permitted.
- 42.2.2 Carburetors: Autolite, Holley, Motorcraft model 5200, Weber 32/36 DFAV or DFEV. Throttle bore sizes: Primary = 1.260", secondary = 1.417". Venturi size = Primary - 1.030", Secondary - 1.070". Any jets may be used. A carburetor wedge (maximum thickness - 1 inch) may be used to level the carburetor. Choke plates may be removed and plugged. Air scoops and velocity stacks are permissible. The intake manifold must be stock as supplied by OEM. If a crack develops on the intake manifold it may be welded on the outside provided that the intake runner surfaces remain untouched in an "as welded" condition. Electric fuel pumps are permitted.
- 42.2.3 **Fuel. (See General Technical 40.18.12)**
- 42.2.4 **Head:** Combustion chamber volume shall be not less than 30cc.
- 42.2.5 The block may be decked. Top of piston may rise above the block surface a maximum of .005".
- 42.2.6 **Camshaft:** Any aftermarket cam can be used providing it meets OEM profile under these class rules. No modification to the rockers or rocker related equipment will be permitted. The camshaft may be advanced or retarded by use of an adjustable cam gear.
- 42.2.7 Valve head sizes intake 1.417", exhaust 1.221". A valve job must be Stock (3 angle) configuration. The last (innermost) angle does not extend more than .250" below the valve seat angle. Any valve guide may be used for replacement. Valve seats may be replaced, only with OEM size seats. Any valve spring that fits the OEM retainer and does not require machining to the head may be used. No modifications to the intake or exhaust ports (grinding and/or polishing) will be permitted. Milling of the "block face" of the head is allowed.
- 42.2.8 Distributor and ignition systems must be stock OEM. Any spark plug wires may be used.
- 42.2.9 The oil pan may be modified to fit the boat and/or to increase oil capacity. The oil pick up to the oil pump may be modified to match the configuration of the pan. Baffles in oil pan are permitted. The valve cover may be modified to help motor venting.
- 42.2.10 Any aluminum flywheel or Toyota Flex Plate is permitted. Ring gear must remain stock.
- 42.2.11 Any cast stock replacement piston available on the open market for 4AC, 2 barrel, single overhead cam, 1587cc Toyota engine may be used.
- 42.2.12 The balancing of reciprocating and rotating parts is permitted.
- 42.2.13 The cylinder head, crankshaft, piston rods, block, oil pump, cam followers shall be OEM.
- 42.2.14 Grinding and/or polishing of carburetors, intake manifold passages, intake and exhaust ports, combustion chambers, connecting rods, valve parts or configuration changes in any way is STRICTLY PROHIBITED.
- 42.2.15 Rings must be stock replacement.
- 42.2.16 Head Gasket: .043 Minimum compressed reading
- 42.2.17 Piston and piston rings may be stock or replacement available on the open market, must meet OEM specification. Milling of pistons is not permitted. The depth of the dish of the piston shall be no smaller than 0.130".

42.3 Recommended minimum inspection procedure for 1.5 Litre Stock Toyota.

- Engine specifications and inspection procedure shall be the responsibility of the 1.5 Litre Technical Committee and the Inboard Chairman.
 - Check combustion chamber: Pistons must not extend above the block surface more than .005. Cylinder head chamber volume 30cc minimum.
 - The depth of the dish must be measured to ensure that it no smaller than 0.130".
 - Check valve train: Camshaft may not be reground. Check valve sizes and face angle. Camshaft may be advanced or retarded by use of an adjustable cam gear.
- 42.3.1 Procedure to check stock cam profile and rocker arms in Toyota 4AC.
 - 42.3.2 Install an 8 inch degree wheel on distributor. Install a pointer on block. It is recommended that the degree wheel have one degree markings.
 - 42.3.3 Rotate engine in normal direction until the lifter is on the heel of the camshaft lobe. Set dial indicator on valve spring retainer. Adjust valve lash until dial indicator reads .001. Set dial indicator back to zero. Rotate engine in normal direction until dial indicator reads .050 stop. Set degree wheel to zero degrees or TDC mark on degree wheel. Rotate engine in normal direction and check every .050 thousandths lift. Read degrees on degree wheel. There is a 4 degree + or - factor for rocker arm wear.

<u>Intake</u>			<u>Exhaust</u>		
	Preload	Degree		Preload	Degree
0.001	Lift	0.0%	0.001	Lift	0.00%
.050		7.5	.100		6
.100		12.5	.150		12
.150		18	.200		17.5
.200		23.5	.250		23

.300	30.5	.300	30
.350	43	.350	42
.364	51 Max	.364	51.5 Max
.350	56	.350	60
.300	69	.300	71
.250	76	.250	78.5
.200	82	.200	84
.150	87	.150	89
.100	92.5	.100	95
.050	99	.050	101

Lobe Separation: Go max lift on intake; Set wheel to 0; Go max lift on exhaust - should read 107.

42.3.5 Check lobe spacing: Set dial indicator on intake valve spring retainer. Rotate the cam until the heel is clear of the rocker arm. Adjust to zero lash and stop at .005 inches valve lift. Set the degree wheel to zero degrees. Rotate the cam in normal direction of rotation to 0.050 inches valve lift. Record the degree wheel reading. Repeat the above procedure on the exhaust valve except that the degree wheel is not reset to zero. The two angle recordings are subtracted to obtain lobe spacing; 107 degrees.

Check carburetor: Throttle bore size: primary = 1.260"; secondary = 1.417". Venturi size = primary - 1.030"; secondary - 1.070", carburetor wedge may be no more than 1" in thickness.

Check all parts for any grinding, polishing and any other alterations from the furnished stock configuration.

RULE 43 - 2.5 LITRE STOCK CLASS

43.1 This class is promoted for the purpose of establishing a low cost stock class engine for racing. To be eligible in the 2.5 Litre Stock Class, a boat must be powered by one stock automotive engine as furnished by the motor manufacturer. Engines must be approved by majority vote of the Technical Committee, Inboard Racing Commission and the Inboard Chairman.

43.2 Approved engines

43.2.1 Ford Pinto 2000cc O.H.C., the Ford 2.3 Litre, SOHC, the Ford "Focus" 2.0 Litre DOHC Duratec, and Honda K20a DOHC. Parts must be used as furnished by the vehicle manufacturers. Alterations are not permitted except as specified herein.

43.2.2 Engines used in the 2.5 Litre Stock class must be a reciprocating piston type.

43.2.3 If other parts from other manufacturers are to be allowed, they will only be those listed in these specifications.

43.2.5 1.9 SEFI GEN II SOHC Ford engine of the 1.5 Liter Stock class. See Rule 42.

43.2 Specifications listed below apply to 2000cc, 124.7 O.H.C. Ford Pinto and the Ford 2.3 Litre.

43.3.1 NOT PERMITTED: gear boxes or devices that alter the speed or direction of power from the motor to propeller.

43.3.2 All parts outside of engine may be removed to permit installation into boat, with the exception of the carburetor and distributor.

43.3.3 Sleeves may be installed to repair worn or damaged cylinder bores.

43.3.4 Velocity tube or ram type air scoop on carburetor is permitted.

43.3.5 Oil pan and pick up may be altered to fit contour of boat. Baffle in oil pan is permitted. Any oil filters or valve cover breathers are permitted.

43.3.6 Engines may be clearanced. Rotating and reciprocating parts may be balanced.

43.3.7 Points, piston rings, spark plugs, bearings, timing belts, resistors, filters, plug wires, fuel lines, condensers may be any stock or replacement parts of any manufacturer sold over the counter to and for the general automobile trade. Gapless or other racing type non-stock configuration rings are not permitted.

43.3.8 Connecting rods may be bushed for the use of floating pins.

43.3.9 Fuel. (See General Technical 40.18.12)

43.3.10 Any changes made to a stock engine eligible for this class other than those itemized in these specifications will be in violation of 2.5 Litre Stock class rule.

43.3 Ford Pinto 2000cc O.H.C. engine specifications:

43.4.1 Maximum displacement 124.7 cubic inches; Bore 3.620 maximum; Stroke 3.029 maximum; Deck height .035 minimum.

43.4.2 Rocker Arm Ratio: 1.6 to 1. Reworking, bushing or use of shims is not permitted.

43.4.3 Head Volume: 46cc min. Head gaskets may be stock or replacement as supplied by OEM. Racing or special head gaskets are prohibited.

43.4.4 Pistons may be stock or replacement parts. ALL PISTONS MUST BE CAST ALUMINUM. The tops of pistons may be machined to meet the .035 minimum deck height requirement. The dimension from the top of the piston to the top of the first ring must be no less than .225 inch.

43.4.5 Valves must be stock. Head size: Intake: 1.653. Exhaust 1.417. Valve face angle 45 degrees. No multiple angles permitted. Any valve grinding allowed for the 2300cc motor is approved for the 2000cc motor. Any valve springs may be used that fit the stock retainers. Cylinder head spring seats and bosses may be machined to fit. Replacement valve guides and valve seats are permitted. Caution: Valve seats must be installed to factory height or max. camshaft lift will be wrong. Max. lift at valve .400 must be maintained.

- 43.4.6** Carburetors: Autolite, Holley, Motorcraft model 5200. Throttle bore size: Primary: 1.260 - Secondary: 1.417. Venturi size Primary: 1.030 - Secondary: 1.070. Carburetor wedge may be used (max. thickness - 1 inch). Holley #2300, part #7448, two jet venturi size 1.190 max. throttle plate size 1.502 max. 350 carburetor. Removal of air cleaner base for installation into boat is permitted. Must be a booster type carburetor.
- 43.4.7** Distributor - Any single fire electronic or points distributor that fits the engine without modification is permitted. Magneto crank triggered or multiple spark discharge systems are not permitted.
- 43.4.8** Pinto flywheels: must be made of aluminum. A minimum wall thickness of 0.468 inches must be maintained throughout the aluminum plate except for pilot and mounting holes, No additional holes permitted. Spot removal of material for balancing purposes only is permitted. Ring gear must remain stock with 135 teeth.
- 43.4.9** Camshaft: must be stock. Part No. DIFZ 6250A and/or replacement Part No. D4FZ6250B. Note - These are the only camshafts permitted in the Pinto engine. Camshaft lift at valve: .400 with zero lash. The camshaft may be advanced or retarded by use of an adjustable cam gear.
- 43.4.10** Fuel pump may be stock or replacement part sold on the open market for general automobile trade, or electric.
- 43.4.11** Grinding and/or polishing of intake manifold combustion chambers, intake and exhaust ports, valve parts, or configuration changes in any way on the Pinto engine is prohibited.
- 43.4.12** Cylinder blocks, cylinder heads, crankshafts and gears, connecting rods, rocker arms, intake manifold, carburetors, camshafts and gears must be stock and supplied by OEM.
- 43.4.13** Any starter may be used on the 2000cc Ford Pinto and Ford 2.3 litre engines. Aircraft type starters are not permitted.
- 43.4** **7 point recommended minimum Inspection Procedure for 2000cc Ford Pinto** (not to preclude single item inspection or more detailed inspection).
- 43.5.1** Check all parts and carburetor for any grinding or polishing.
- 43.5.2** Check top ring location. Place brass feeler gauge between cylinder wall and piston. From top of piston to top of ring should read no less than .225.
- 43.5.3** Check cylinder head volume: 46cc. Deck height: .035 Min.
- 43.5.4** Check valve sizes: Intake: 1.653 Exhaust: 1.417
- 43.5.5** Bore: 3.620 Max. Stroke: 3.029 Max.
- 43.5.6** Check carburetor venturi sizes: Holley #5200, primary: 1.030 secondary: 1.070. Holley #7448, venturi size 1.190 max. throttle plate 1.502 max.
- 43.5.7** Procedure to check stock camshaft profile and rocker arms in Pinto engine (part #DIFZ6250A or D4FZ6250B) using stock flywheel with 135 teeth or 2.66 degrees per tooth.
- 43.5.8** Rotate engine in the normal direction until the heel of the intake lobe is clear of the rocker arm. Set dial indicator on intake valve spring retainer. Adjust valve to zero lash and stop when dial indicator reads .001. Reset dial indicator back to zero. Rotate engine in normal direction and stop when dial indicator reads .020. Reset dial indicator back to zero. Mark flywheel with chalk and set pointer on the chalk mark. Now start procedure listed.

<u>Lifts in Thousandths</u>	<u>Number of Flywheel Teeth</u>	<u>Degrees</u>	
.050	7	19	
.100	11	29	s
.150	15	40	
.200	19	51	opening
.250	23	61	ramp
.300	28	75	
.350	35	93	
	46	125	t
With valve set at zero lash, max. lift at valve 48		not to exceed 128	.400
Dwell			
.350	58	155	s
.300	65	173	
.250	70	187	closing
.200	74	197	ramp
.150	78	208	
.100	82	219	
.050	86	229	
0 or .020	106	283	t

Check Lobe Spacing and Max. Valve Lift. Set dial indicator on valve spring retainer. Set intake and exhaust valve to zero lash. Rotate engine until dial indicator reads .050 on the opening side of intake lobe. Mark flywheel. Rotate engine in normal direction. Do the same procedure on the opening side of exhaust lobe. Mark flywheel. Count teeth between the two marks. It should read 50 teeth.

43.5 Ford 2.3 Litre Engine Specifications

- 43.6.1** The engine must be a Ford 2300cc OHC cast iron engine. Grinding, polishing or blasting any internal part that results in smoothing, recontouring or enlarging is prohibited. Configuration changes in any way on the Ford 2.3 Litre engine are prohibited.
- 43.6.2** Parts must be used as furnished by Ford or OMC. No alterations permitted except as specified herein.

43.6.3 Bore 3.825 maximum and stroke 3.126 maximum.

43.6.4 Windage tray and/or crankshaft wipers are permitted.

43.6.5 Cylinder heads- Only flat milling is allowed, angle milling is not permitted. Bronze wall valve guides are permitted. Valve guides may be machined to accept any stock or stock replacement valve stem oil seals. Replacement valve seats are permitted (must meet OEM specifications).

43.6.5.1 – Head option 1: Esslinger Ford Aluminium D-port, Ford part number M-6049-E23A. Heads must have the official ABPA or ACHA stamps on at all times. Head must remain unaltered in any way except for the following: Casting and machining mismatch in the area under the valve cover may be contoured to allow for better oil return. No changes are permitted in the valve area. Combustion chamber volume and compressed head gasket minimums: at 61cc the top of the piston must be below the top surface of the compressed head gasket a minimum of 0.040", at 60cc the top of the piston must be below the top surface of the compressed head gasket a minimum of 0.046" Intake and Exhaust valve seats may be reworked (valve job) but touching and/or altering the aluminum part of the bowl is prohibited.

43.6.5.1.1 Valves: Exhaust: Manley # 11793 and 11795 (dia. 1.590" \pm 0.010"). Ferrea F6227 (1.600Dia +/-0.010)and Ferrea F6222 (1.590 Dia +/-0.010) Single 45 degree angle only. Intake: Man-ley # 11792 and 11794 (dia. 1.890" \pm 0.010"), Ferrea F6226 (1.890Dia +/- 0.010) and F6221 (1.890 Dia +/-0.010). Single 45 degree angle only.

43.6.5.1.2 Valve Springs: Maximum spring O.D. 1.460", no conical springs permitted. Any steel replacement retainer (1.460" max diameter) and keepers permitted no titanium. Spring seat may be machined to accept hardened spring seats and 1.460" valve springs.

43.6.5.2 Head option 2: Any cast iron cylinder head supplied by Ford with correct valve size may be used that meets the minimum chamber volume (heart shaped chambers do not meet the minimum). Dual plug heads prohibited. Intake and Exhaust valve seats may be narrowed by cutting at 90 degrees or less, not to exceed .250 from combustion surface into bowl area. The following Ford 2.3 conversion head plates may be used: Goodson Automotive part number FAP-2300-EFI or K-Line part number KL9661. This plate may be fitted to the cylinder head. Total thickness of adapter mounting flange and 2 gaskets (1 each side) not to exceed .500" total combined.

43.6.5.2.1 Valves: Valve head diameter: Intake valve 1.735". Intake valve may have 20 degrees back cut, not to exceed .205 in width. Exhaust valve 1.500" with no back cut. Minimum valve stem diameter: 0.340".

43.6.5.2.2 Valve Springs: Any spring that fits the head without machining. Maximum spring O.D. 1.460", no conical springs permitted. Any stock or stock steel replacement retainer that fits the stock keepers may be used. Retainer must not be modified.

43.6.5.3 Head option 3: Any cast iron D-port cylinder head supplied by Ford and modified by BoPort Racing Heads (www.BOPORT.com, 775.884.3000). Heads must have "BOPORT, CNCST3" marking on it. Except for the work done by BOPORT, head must remain unaltered in any way. No changes are permitted in the valve area. Combustion chamber volume: 61cc minimum. Intake and Exhaust valve seats may be reworked (valve job) but touching and/or altering any area of the bowl is prohibited.

43.6.5.3.1 Valves: Exhaust Manley # 11793 and 11795 (dia. 1.590" \pm 0.010"). Ferrea F6227 (1.600 Dia. +/-0.010)F6222 (1.590Dia +/-0.010) Single 45-degree angle only. Intake: Manley # 11792 and 11794 (dia. 1.890" \pm 0.010"), Ferrea F6226 (1.890 Dia +/-0.010) and F6221 (1.890 Dia +/- 0.010). Single 45-degree angle only.

43.6.5.3.2 Valve Springs: Maximum spring O.D. 1.460", no conical springs permitted. Any steel replacement retainer (1.460" max diameter) and keepers permitted no titanium. Spring seat may be machined to accept hardened spring seats and 1.460" valve springs.

43.6.6 Camshaft: Any aftermarket cam can be used providing it meets profile under these class rules. Maximum lift at valves **0.406 inches (+1% or 0.410" max. for tolerance)**. (See inspection procedure to check camshaft.) Suggested camshafts are **CamCraft 38-APBA** or Melling SFP-2.

43.6.7 Lifters: Any stock or stock replacement hydraulic lifter may be used. Anti-pump up lifters is permitted.

43.6.8 Rocker arms: Stock or stock replacement with a ratio of 1.64 to 1. Roller rocker arms are not permitted. Stock replacement followers with wear pads such as Esslinger eng E2293, Race eng cr-66993-8, or Racer Walsh RWA 1484 can be used and are considered stock replacement.

43.6.9 Adjustable cam gears are permitted.

43.6.10 Pistons: Federal Mogul #H435P or #495P, additionally SRP #148221 or #148222. Pistons may not be reversed. The minimum distance from the top of the piston to the top of the first ring shall be no less than: Federal Mogul: 0.245", SRP: 0.195". Straight walled piston pins as received from the piston manufacturer shall be used. Piston rings must be of the type supplied by Ford. The first and second rings (compression) must be one piece design. The third ring must be a three piece design consisting of two rails and one expander.

43.6.11 Intake manifold: OMC part number #912470 or Esslinger engineering part #2724.5 (626-444-4919). When using the Esslinger intake, matching of the intake and the spacer is allowed by contouring the inside of the intake to a maximum of 0.750" deep. No other modification to the inside of the intake is permitted. The use of any deflector is prohibited.

43.6.12 Carburetors: Any Rochester 2 GC carburetor will be allowed as long as the throttle bore diameter is no larger than 1.690 and venturi diameter is no larger than 1.320. Additionally, Holley model 2300 part #0-4412 and HP 0-80583-1 venturi diameter 1.380 max.,

throttle bore diameter 1.690 max. Holley #2300, part #0.7448 and HP 0-80787-1 two jet venturi size 1.190 max., throttle plate size 1.502 max. 350 CFM carburetor. Removal of air cleaner base for installation into boat is permitted. Must be a booster type carburetor. No polishing allowed. The carburetor must have a choke horn and it must remain untouched, however the choke plate may be removed. Only the original components of the carburetor manufacturer may be used (No billet metering blocks, or boosters), however, Holley jets may be used in the Rochester carburetor. Fine tuning of jets, power valves, float bowl, metering block, accelerator pump and nozzles is permitted. A carburetor wedge may be used. The total dimension of wedge and gaskets measured from the intake manifold to carb base shall not exceed 1.250 inches.

43.6.13 Fuel pump: Must be original stock or stock replacement mechanical or electric fuel pump sold on open market for general automobile trade. A fuel pressure regulator may be used.

43.6.14 Distributor: Any single fire electronic or points distributor that fits the engine without modification is permitted. Magneto crank triggered or multiple spark discharge systems are not permitted.

43.6.15 Flywheels: Aluminum flywheels are mandatory. The ring gear shall remain stock with 132 teeth or the 2000 Pinto ring gear with 135 teeth and a minimum wall thickness of 0.468 inches must be maintained throughout the aluminum plate except for pilot and mounting holes. No additional holes permitted. Spot removal of material for balancing purposes only is permitted.

43.6.16 Water passages may be blocked.

43.6.17 Starter: any starter that functions like the stock starter. Blocks may be clearanced to allow for starter installation only.

43.6 Recommended Minimum Inspection Procedure for Ford 2.3 Litre Engine

43.7.1 Engine specifications and inspection procedures shall be the responsibility of the Technical Committee and the Inboard Chairman.

43.7.2 Check combustion chamber: Minimum distance from top ring to the top of the piston: Federal Mogul: 0.245", SRP: 0.195". At 61cc the top of piston must be below the top surface of the compressed head gasket a minimum of 0.040", at 60cc the top of the piston must be below the top surface of the compressed head gasket a minimum of 0.046". Top of piston must be below the top surface of the compressed head gasket a minimum of 0.040". Cylinder head chamber volume 61cc minimum. Dual plug heads or roller rocker arms are prohibited.

43.7.3 Check valve train: Valve sizes and face angle. Camshaft may be advanced or retarded by use of an adjustable cam gear.

43.7.4 Check cam/valve action: Install adjustable lifters in place of hydraulic lifters on one intake and one exhaust valve. Set dial indicator on intake valve spring retainer. Install an 8 inch degree wheel on cam pulley bolt. Install a pointer on block. It is recommended that the degree wheel have one degree markings. To read angles to one degree, rotate the cam until the lobe is clear of the rocker arm. Adjust the valve to zero lash and set the dial indicator to zero. Set the degree wheel to zero degrees, rotate the cam in normal direction of rotation to 0.050 inches valve lift. Set the degree to 17 degrees. Repeat for each 0.050 of increasing and decreasing valve lift as shown in the table. At the point of maximum lift, note the angular width of the flat area. Repeat with the exhaust valve. Compare recorded data with the table data.

Valve Lift Thousandths	Intake Angle Degrees	Exhaust Angle Degrees	
s .050	17	17	s
.100	22	22	
.150	27	27	
Opening 200	32	32	Opening
Ramp 250	37	37	Side
.300	43	43	
.350	51	51	
.400	67	67	
.402*	70*	70*	t
Max lift at valve with zero lash			
.402*	73*	72*	
s .400	75	74	s
.350	91	90	
.300	99	99	
Closing .250	105	104	Closing
Ramp .200	110	110	Side
.150	115	115	
.100	120	120	
.050	126	126	*Edge readings for "flat" area.

43.7.5 Check lobe spacing (Use setup of prior check): Set dial indicator on intake valve spring retainer. Rotate the cam until the heel is clear of the rocker arm. Adjust valve to zero lash and stop at .0005 inches valve lift. Set the degree wheel to zero degrees. Rotate the cam in normal direction of rotation to 0.050 inches valve lift. Record the degree wheel reading. Repeat the above procedure on the exhaust valve except that the degree wheel is not reset to zero. The two angle recordings are subtracted to obtain lobe spacing; 111 degrees.

43.7.6 Check carburetor Rochester: Venturi - 1.320 inches diameter maximum. Throttle bore 1.690 inches diameter maximum. Holley #0-4412 or HP 0-80583-1, venturi 1.380 max., throttle bore 1.690 max. Holley #0-7448 or HP 0-80787-1, venturi 1.190 max, throttle bore 1.502 max.

43.7.7 Check all parts for any grinding, polishing and any other alterations from the furnished stock configuration. However, the distributor intermediate shaft is not inspectable. Throttle shaft may be altered or modified for connecting to the throttle cable. No thinning of throttle shaft is allowed; must maintain stock diameter.

43.7.8 Inspector may disassemble hydraulic lifter to insure it is approved. Inspector will inspect the Lifter Boss in the head for any alterations. The Inspector will verify that the lifter is hydraulic by compressing the lifter to a min. of .175.

43.7 Ford 2.0L DOHC Duratec Engine Specifications

43.8.1 Engine must be a 2005-2009 Ford "Duratec 20" 2.0L, 4 cylinder, DOHC (non-direct injected, non-variable valve timing), block casting 2.0L.

43.8.2 Parts must be used as furnished by Ford. No alterations permitted except as specified herein. No grinding of factory cast parts.

43.8.3 Bore maximum: 3.464" (88.0mm) (this is .5mm or .020" overbore) and Stroke maximum 3.279" (83.3mm)

43.8.4 Maximum compression ratio of 10.3:1

43.8.5 Oil pan, pickup, and filter system may be altered to fit boat and incorporate baffles, windage tray and/or crankshaft wipers. Oil pan must remain a wet sump system.

43.8.6 Cylinder Head

43.8.6.1 Minimum distance from top of piston at TDC to top of compressed head gasket .040"

43.8.6.2 Minimum combustion chamber volume: 42.0cc

43.8.6.3 Head must remain unaltered in any way except the following: only flat milling is allowed and intake and exhaust valve seats may be reworked (valve job) but touching and/or altering the aluminum part of the bowl is prohibited.

43.8.6.4 Any stock or equivalent, stock replacement head gasket may be used; recommend Ford Part Number: 1S7Z-6051-AA

43.8.6.4.1 Minimum compressed gasket thickness of .022"

43.8.6.5 Exhaust Valves must meet the following specifications:

43.8.6.5.1 Head diameter: 1.175" ±.010"

43.8.6.5.2 Stem diameter: .2151"-.2157" (5.465-5.480mm)

43.8.6.5.3 Single 45 degree angle only

43.8.6.5.4 No back cut allowed

43.8.6.5.5 Must not be made of titanium or "exotic" materials

43.8.6.6 Intake Valves must meet the following specifications:

43.8.6.6.1 Head diameter: 1.372 ± .010"

43.8.6.6.2 Stem diameter: .2153-.2159" (5.470-5.485mm)

43.8.6.6.3 Single 45 degree angle only

43.8.6.6.4 Full length of valve stem must remain within diameter range.

43.8.6.6.5 No back cut allowed

43.8.6.6.6 Must not be made of titanium or "exotic" materials

43.8.6.7 Valve springs: any stock or stock replacement valve springs, retainers, and keepers of OEM style may be used. No titanium or "exotic" materials allowed.

43.8.7 Camshafts - factory Ford or any aftermarket stock replacement may be used provided it meets the following specifications:

43.8.7.1 Exhaust camshaft maximum lift: .317"

43.8.7.2 Intake camshaft maximum lift: .358" *Note: Dial indicator MUST be aligned with the angle of the valve for accurate measurement.

43.8.7.3 Lobe spacing must be 112 degrees +/- 2 degrees

43.8.7.4 Cam Followers (tappets):

43.8.7.4.1 Any stock or aftermarket (adjustable shim style) cam followers (tappets) may be used. No titanium or "exotic" materials.

Valve timing may not be adjusted. No clocking of camshafts relative to crank is allowed. Camshaft alignment tool must be able to be inserted into slots on the backside of camshafts with cylinder #1 at TDC.

43.8.8 Pistons - Must be factory Ford or Stock equivalent replacement. No modifications to piston or connecting rod allowed except as specified in rule 40.15.

43.8.8.1 Piston rings must be of the type supplied by Ford. The first and second rings (compression) must be one piece design. The third ring must be a three piece design consisting of two rails and one expander.

43.8.8.2 Piston ring thickness minimum:

43.8.8.2.1 Top ring (compression): .0460" (1.17mm)

43.8.8.2.2 Second ring (compression): .0460" (1.17mm)

43.8.8.2.3 Third Ring (oil): .0937" (2.38mm)

43.8.8.3 Piston pins are press fit to rod

43.8.8.4 The minimum distance from the top of the piston to the top of the first ring shall be no less than: 0.180"

43.8.8.5 Pistons must be dished type as supplied from the factory.

43.8.9 Connecting Rods: Must be OEM.

43.8.9.1 Length (center to center): 5.758" (146.3 mm)

43.8.10 Intake Manifold - must be factory Ford plastic manifold. No alterations allowed except the following:

43.8.10.1 Vacuum ports may be used as reference for fuel pressure regulator.

43.8.10.2 Unused vacuum ports may be plugged.

- 43.8.10.3** Intake Manifold “tumbler flaps” may be removed to avoid potential failure and subsequent engine damage.
- 43.8.10.4** Any aftermarket intake tube and/or air filter may be used in combination with the factory Mass Air Flow Sensor. The inside diameter of the tube or insert must be 2.362” (60mm) at the location of the MAF
- 43.8.10.5** Throttle body must remain as from the factory, no modifications allowed. Inside diameter of throttle body at opening must be between 2.55-2.60”.

43.8.11 Electrical System

- 43.8.11.1** Engine to be controlled and run with an unaltered OEM powertrain control module (PCM) falling within the range of the following part numbers:

ECU Part Numbers

- 2005** - 5S4A-12A650-BA thru BG
 - 5S4A-12A650-DA thru DB
 - 5S4A-12A650-HA thru HG
 - 5S4A-12A650-PA thru PB
 - 5S4A-12A650-SA thru SF
 - 5S4A-12A650-VA thru VF
 - 5U7A-12A650-BDA thru BDARM
 - 5U7A-12A650-BDB
 - 5U7A-12A650-BEA thru BEA
 - 5U7A-12A650-DTA thru DTARM
 - 5U7A-12A650-DUA thru DUARM
 - 5U7A-12A650-YA thru 5U7A-12A650-YB

- 2006** - 6S4A-12A650-CA
 - 6S4A-12A650-EA
 - 6S4A-12A650-GA
 - 6S4A-12A650-HA
 - 6S4A-12A650-KA thru KB
 - 6S4A-12A650-LA thru LB
 - 6S4A-12A650-MA thru MC
 - 6S4A-12A650-NA thru NC
 - 6S4A-12A650-RA
 - 6S4A-12A650-SA
 - 6S4A-12A650-TA thru TB (+2007)
 - 6S4A-12A650-UA thru UC (+2007)
 - 6U7A-12A650-BNA (+2007)
 - 6U7A-12A650-BPA (+2007)
 - 6U7A-12A650-BRA
 - 6U7A-12A650-BSA

- 2007** - 7S4A-12A650-PA thru PC
 - 7S4A-12A650-RA thru RC
 - 7S4A-12A650-UA

- 43.8.11.2** OBDII port MUST be retained and function properly (this is recommended for diagnostic purposes as well).

- 43.8.11.3** Wiring harness may be modified or custom made to use any fuse/relay system to power the engine.

- 43.8.11.4** Unused circuits into or out of the ECU may have the wire/pins removed but remaining pins must be in the factory locations; in other words, the pinout locations must remain as from the factory.

- 43.8.11.5** Any sensor may be removed or disconnected, but shall not be modified or altered to perform or record values in any way other than its OEM intended method with the following exceptions:

- 43.8.11.5.1** Downstream O2 sensor (#2) may be “tricked” to report exhaust gasses as if a catalytic converter were present.
- 43.8.11.5.2** Output Shaft Speed sensor (transmission) may be mounted in such a way as to report a theoretical speed to the PCM thereby “tricking” the PCM into allowing the fuel injectors to actuate.

43.8.12 Fuel System:

- 43.8.12.1** Any electric fuel pump sold on open market for general automobile trade may be used.

- 43.8.12.2** A fuel pressure regulator must be used. Fuel pressure must be between 45-75psi (recommend 55psi).

- 43.8.12.3** Return type fuel pressure regulator is allowed in lieu of factory returnless fuel system

- 43.8.12.4** Fuel injectors must be 12ohm resistance, have a flow rate of 240cc/min (22.83lb/hr) @ 43.5psi and be Bosch EV6 Type with USCAR electrical connector

- 43.8.12.4.1** California emissions (orange, 12 holes) or standard emissions (blue, 4 holes) injectors may be used

- 43.8.12.4.2** California emissions injector part numbers allowed: CM5062 (Motorcraft), 3S4G-AB (Ford), 0280156161 (Bosch)

43.8.12.4.3 Standard emissions injector part numbers allowed: CM5086 (Motorcraft), 3M6G-BA (Ford), 0280156162 (Bosch)

43.8.13 Exhaust system:

43.8.13.1 EGR (Exhaust Gas Recirculation) valve/system may be removed and blocked off.

43.8.13.2 Any exhaust header type/style may be used.

43.8.14 Starting System:

43.8.14.1 Any starter that functions like the stock starter may be used in the stock location.

43.8.15 Cooling System:

43.8.15.1 Cooling system parts may be altered, removed and/or blocked off in favor of typical “forced raw water cooling”.

43.8.16 Flywheel - must be Ford OEM flywheel or flex plate

43.8.16.1 Flywheel or flex plate may be balanced only

43.8.16.2 Ring gear must have 112 teeth and OD must be 11.125” minimum

43.8.17 Oil system - oil filter may be relocated to suit fitment to boat.

43.8.17.1 Any aftermarket oil filter system/relocation kit may be used.

43.8.18 Ignition System

43.8.18.1 Crank trigger wheel must be factory 36-1 configuration and remain in stock position relative to crank. No altering or clocking to adjust timing is allowed.

43.8.18.2 Ignition coils must be OEM or OEM equivalent replacement coil-on-plug. No “performance” versions may be used.

43.8.18.3 To prevent tampering with the programming within the PCM (computer), a modified “claimers” rule may be enacted by a person who suspects cheating. The accused boat will be made to replace the existing PCM in the boat with another known good “sealed” PCM. Because tuning the PCM requires a VIN number from the vehicle it was removed from, it will prevent further tampering as the new VIN will be unknown.

43.8 Recommended Minimum Inspection Procedure for Duratec 2.0L (“Focus Motor”)

43.9.1 Check combustion chamber: Minimum distance from top ring to the top of the piston: 0.180”. Cylinder head chamber volume 42.0cc minimum. Flat portion of piston must be below gasket (installed on head) a minimum of .040”. Compressed head gasket thickness must be a minimum of .022”.

43.9.2 Check valve train: Valve sizes and face angle. Camshafts must be able to be aligned with alignment tool at TDC on cylinder #1

43.9.3 Check cam/valve action: Install degree wheel on crank or flywheel. *Note the crank pulley bolt cannot be removed easily without first locking the cams in place or cam timing will be lost due to lack of a keyed timing gear on these engines. It is therefore likely preferable to install on the flywheel. Install a pointer on the block. It is recommended that the degree wheel have one degree markings. Rotate engine in the normal direction until the intake cam is just closed and the lobe is clear of the follower bucket. Install dial indicator vertically and perpendicular to the camshaft base circle at the 12 o’clock position. Set the dial indicator to zero. Rotate the crankshaft in normal direction of rotation to .001” lift. Reset dial indicator to 0, set the degree wheel to 0. Continue rotation in normal direction to .050” and record the crank angle. Repeat for each 0.050” of increasing and decreasing valve lift as shown in the table. At the point of maximum lift, note the angular width of the flat area. Repeat with the exhaust cam. Compare recorded data with the table data. All measurements are ±2 degrees.

INTAKE VALVE LIFT THOUSAND	CRANK ANGLE DEGREE	EXHAUST VALVE LIFT THOUSANDTHS	CRANK ANGLE DEGREES
.050”	71	.050”	76
.100”	91	.100”	96
.150”	106	.150”	109
.200”	116	.200”	120
.250”	125	.250”	129
.300”	134	.300”	139
.350”	144	.317” max	Opening 147
.358” max	Opening 149	.317” max	Closing 148
.358” max	Closing 151	.300”	155
.350”	156	.250”	165
.300”	166	.200”	175
.250”	175	.150”	185
.200”	183	.100”	199
.150”	194	.050”	220
.100”	207		
.050”	227		

43.9.4 Check lobe spacing: Set engine to approximately TDC on the compression stroke on cylinder #1. Set dial indicator on exhaust valve tappet (bucket) using a suitable extension. Make sure the indicator is inline with direction of the valve. Zero the dial indicator. Zero the degree wheel. Rotate the engine in the normal direction until .010” before max lift, record angle on the degree wheel. Continue rotating in the normal direction until .010” after max lift. Record angle on degree wheel. Subtract first number from the second and divide by two. Add this number to the first recorded number. Turn engine backwards past the result and return to it by turning in the normal rotation again. This is maximum lift. Set degree wheel to 0 and DO NOT rotate the crank. Move the dial indicator to the intake

side and set the dial indicator on the valve tappet (bucket) in the same manner as before. Repeat the same process as the exhaust side to find maximum lift. Record the angle on the degree wheel. Divide this by two to determine Lobe Separation Angle (lobe spacing). Must be 112 degrees +/- 2 degrees.

43.9.5 Check all parts for any grinding, polishing and any other alterations from the furnished stock configuration. Throttle shaft may be altered or modified for connecting to the throttle cable. No thinning of throttle shaft is allowed; must maintain stock diameter.

43.9 This engine option is under probation for the 2019 and 2020 season. The IRC may make changes to the rules as needed. No records may be set by this engine option during the probation period. The engine option may participate in a divisional or summer championship but will not be awarded national points or the championship during the probation period.

43.11 Honda K20A Engine Specifications

43.11.1 Must be a stock production-style Honda engine, specifically ACURA RSX (2002-2006) or HONDA CIVIC SIR (2002-2006) with a plastic intake. Permitted models: K20A3 USDM North America (2002-2006), 160 hp, 1996cc, or K20A Japan market 160 hp (excluding K20A2 type R). When using Honda Civic SI USA (SIR for Canada) 2002-06, intake manifold needs to be replaced for the plastic intake manifold. (SEE article 43.18.1).

43.11.2 Identification numbers must remain intact.

43.12 Gearbox

43.12.1 1 Honda engine option only; multi-speed or adjustable gearboxes are prohibited.

43.12.2 Clutch or belt drive systems are not allowed.

43.12.3 Maximum of 2 gears; gears must be 6-splines, 1 inch wide, and purchased over the counter. Gears cannot be modified in any way, no custom gears allowed.

43.12.4 No conical or exotic gear is allowed.

43.13 Crankshaft

43.13.1 OEM crankshaft, part number 13310-PNA-000. Knife edging not allowed.

43.13.2 Bore and stroke: 86.62mm (3.41") max bore and 85mm (3.346) max stroke.

43.13.3 OEM steel flywheel, part number 22100-PND-003 or Luk LFW407 and a minimum weight of 14 pounds (6.35 kilos), with no additional holes.

43.14 Connecting Rods

43.14.1 OEM steel connecting rods only, part number 13210-pnc-000.

43.14.2 Aftermarket connecting rods not allowed.

43.14.3 Center line 5.437" +/- .010" (138.1mm).

43.14.4 Weight: 476 grams +/- 5 grams (16.79 ounce +/- .18 ounces).

43.14.5 OEM connecting rod bolt, part number 13204-P8A-A01.

43.15 Pistons

43.15.1 Spec Wiseco piston, part number K631M865 86.5mm (3.405 inch) is oversized (+0.020). OEM stock piston is also allowed.

43.15.2 Deck height max is .127mm (.005 inch) above the block.

43.16 Camshaft and Valve Train

43.16.1 OEM camshaft, part numbers 14110-PPA-010 and 14120-PPA-010, with specified intake and exhaust duration and lift. Intake max lift: 0.372" (9.45mm) and Exhaust max lift: .383" (9.73mm).

43.16.2 Honda K20A cam profile procedure:

Install a degree wheel on the exhaust cam gear. Remove valve lash from intake and exhaust rockers arms being checked. Set up dial indicator on valve retainer in line with valve travel. Rotate crankshaft in clockwise rotation until

.050 valve lift is achieved and set pointer to TDC on degree wheel. Rotate crankshaft to take degree readings at the following indicator readings. Repeat procedure for intake cam.

<u>Intake</u>		<u>Exhaust</u>	
Lift in (inches)	Degrees	Lift in (inches)	Degrees
@ .050	TDC	@ .050	TDC
@ .100	7	@ .100	6
@ .150	12	@ .150	11
@ .200	17	@ .200	16
@ .250	23	@ .250	22
@ .300	31	@ .300	29
@ .350	43	@ .350	39
@ .372	MAX LIFT	@ .383	MAX LIFT
@ .350	62	@ .350	62
@ .300	75	@ .300	72
@ .250	82	@ .250	78
@ .200	88	@ .200	84
@ .150	94	@ .150	89
@ .100	100	@ .100	94
@ .050	106	@ .050	100

The smaller secondary intake lobe lift is .074" (1.87mm) max and not able to profile.

43.16.3 Valve angles: OEM and factory valve angles only. Ferrea intake and exhaust parts must remain unmodified. FERREA valve permitted - intake F5510 - exhaust F1546P.

43.16.4 Ferrea intake valve F5510- Head Diameter: 35 mm (1.377"), Stem Diameter: 5.47 mm (.215"), Overall Length: 109.3 mm (4.303"), Tip Length: 2.5 mm (.098").

43.16.5 Ferrea exhaust valve F1546P- Head Diameter: 34 mm (1.338"), Stem Diameter: 5.47 mm (.215"), Overall Length: 102.35 mm (4.029"), Tip Length: 2.5 mm (.098").

43.17 Cylinder Head

43.17.1 OEM cylinder head, part number 12100-PNC-010, must remain unaltered. (PNC - casting number on head)

43.17.2 Head surfacing allowed combustion chamber volume 49cc minimum.

43.17.3 Head gasket minimum compressed thickness .025" (.635 mm).

43.17.4 No changes are permitted in the valve area.

43.17.5 Must use Supertech valve springs and retainers, part number SPRK-M1007S-K2 (tested at 74 pounds and must be less than 39.8 mm (1.566")).

43.17.6 No cutting of spring seats or shims permitted.

43.18 Intake Manifold

43.18.1 Must be OEM plastic only, part numbers 17100-PNC-J0 or 17100-PPA-A01.

43.18.2 Milling or polishing is not allowed.

43.19 Throttle Body

43.19.1 OEM throttle body, part number 06160-PND-A62.

43.19.2 Grinding or polishing of the air inlet port is not allowed.

43.19.3 The throttle body bore inner diameter at mounting surface 3.350" +/- .010" Max (85.09mm +/- .254mm).

43.19.4 Only original components of the throttle body from the manufacturer may be used.

43.20 Ignition

43.20.1 Ignition coil part numbers: OEM 30520-RRA-007, Denso 673-2301, Hitachi IGC4030, and Hitachi IGC4030D.

43.21 Fuel Delivery

43.21.1 Injectors permitted: Honda 16450-PPA-A01 or OEM equivalent, recommended part number is Hitachi FIJ0061. The ECU is configured with the locked tune file specifically calibrated for these injectors. Use of non-compliant injectors may lead to suboptimal performance or failure.

43.21.2 Fuel Pressure must be between 48-52 PSI - Any pump can be used. Pressure monitored through ECU and a mandatory fuel pressure sensor.

43.22 Oil System

43.22.1 Must use stock steel oil pan; modification for oil sump permitted.

43.22.2 OEM oil pump only, part number 15100-PRB-A01.

43.22.3 Wet sump is required.

43.23 ECU (Engine Control Unit)

43.23.1 G4X MonsoonX ECU, part number 127-4000

43.23.2 The computer (ECU Link G4X MonsoonX) must be installed behind the cockpit in the engine compartment.

43.23.3 Unique APBA ECU Tune file mandatory – Contact Inboard Chairman for ECU programming instructions. ECU may be reprogrammed at race site by the inspector.

An 8 inch 'Precision Auto' sticker must be affixed to the exterior of the boat.

43.22.4 ECU serial number must be provided to APBA through IRC administrator.

43.23.5 Fuel pressure sensor connected to your supplied Link 0-100 psi ECU is mandatory. AEM PN: 30-2130-100

43.23.6 Oxygen sensor and Link CAN Lambda: Bosch oxygen sensor, part number 17025 (Bosch LSU4.9), connected to the Link CAN Lambda, part number 125-1000, is mandatory.

- All the following motor sensor data is mandatory and must be working properly, data log files may be required by inspector after any heat.
- IAT : Intake Air Temp
- ECT : Engine coolant Temp
- TPS : Throttle Position Sensor
- MAP : Manifold Absolute Pressure
- Fuel Pressure HRL sensor kit PN: HRL_FP
- Lambda1: Lambda reading air/gas mixture (Link Lambda sensor)
- Properly means it's installed and used in the manner it was intended for.

43.24 Headers

43.24.1 Only Schoenfeld headers, part number F9284V3M-HP and F9284V3M-HP, -NP (no paint), are allowed; The extension at the end of the collector shall not exceed 28" inches in length and 3 inches in outside diameter, no modification is allowed.

43.24.2 May install weld-on fittings for sensors such as mandatory o2 sensor at the end of the collector prior to the extension.

RULE 44 - 2.5 LITRE MODIFIED CLASS

44.1 Competing boats shall be powered by one internal combustion motor of the four-cycle type, utilizing any combination of displacement, configuration and fuel as defined below. Unless otherwise noted, the engine will have no more than 6 cylinders and any block/cylinder head combination can be utilized.

Engine Configuration	Engine Displacement	Fuel	Minimum Weight	Capsule Req.	Pounds/Cu In Displacement
(Up to max progression)	(Up to max noted)		(With Driver)	(Reg. On Capsule)	(Reference)
DOHC - 4 Valve	148.5 Cubic in.	Gas	1025 Lbs.	2.5 Stock	6.90 Lbs.
DOHC - 4 Valve*	148.5 Cubic in.	Methanol/Ethanol	1125 Lbs.	2.5 Stock	7.57 Lbs.
SOHC - 2 Valve	155.5 Cubic in.	Gas	1125 Lbs.	2.5 Stock	7.23 Lbs.
SOHC - 2 Valve	155.5 Cubic in.	Methanol/Ethanol	1225 Lbs.	2.5 Mod	7.87 Lbs.
SOHC - 2 Valve	166 Cubic in.	Gas	1225 Lbs.	2.5 Mod	7.38 Lbs.
SOHC - 2 Valve	166 Cubic in.	Methanol/Ethanol	1325 Lbs.	2.5 Mod	7.98 Lbs.
Push Rod - 2 Valve**	313 Cubic in.	Gas	1525 Lbs.	5 Litre	4.87 Lbs.

* Note: Engines using methanol must use production blocks and head(s), but they may be modified.

** 44.2.4 Any boat meeting Rules 45.1, 45.2, and 45.4 shall be considered legal within the 2.5 Mod. Class

Note: Engine progression: Push Rod - 2 valve, SOHC - 2 valve, SOHC - 4 valve, DOHC - 2 valve, DOHC - 4 valve

Note: Hulls using a 2.5 Stock capsule are not legal to step up to run as a National Mod.

44.2 Engine combinations.

44.2.1 Boats using single or multiple overhead cams and/or more than 2 valves per cylinder must have a displacement not exceeding 148.5 cubic inches and no more than 6 cylinders. The weight minimum shall be 1025 pounds and the fuel shall be restricted to gasoline only. Note: 2.5 Stock hulls may compete in the 2.5 Mod class when running on gasoline at a minimum weight of 1025 lbs. if they meet the minimum capsule requirements of the 2.5 Stock class. As an alternative, methanol may be used but the minimum weight shall be increased to 1125 pounds. Note: Engines using methanol must use production blocks and head(s). Hulls used in 44.2.1 that are running on methanol at a minimum weight of 1125 lbs., must meet the capsule requirements of the 2.5 Modified class.

44.2.2 Boats using engines with pushrods or a single overhead cam, with no more than 2 valves per cylinder, and a displacement not exceeding 155.5 cubic inches, shall weigh a minimum of 1125 pounds when running only gasoline, and shall weigh a minimum of 1225 pounds if running on methanol, or ethanol- based fuels.

44.2.3 Boats using engines with pushrods or a single overhead cam, no more than 2 valves per cylinder, and a displacement not exceeding 166.0 cubic inches, shall weigh a minimum of 1,325 pounds. Fuel shall be gasoline, methanol, or ethanol-based fuels.

44.2.4 Any boat meeting Rule 44.2.1, 45.1, 45.2, 45.4 shall be considered legal within the 2.5 Litre Modified Class. This combination is NOT considered legal in the National Modified Class.

RULE 45 - E 350 CLASS

All engines and their modifications must be approved by the Technical Committee. Following are the approved engines and their respective technical rules.

45.1 General Motors 305 Cu. In. Engine

45.1.1 The engine must be a General Motors V-8 305 Cubic Inch 2 barrel carburetor motor.

45.1.2 Grinding, polishing or blasting any internal part that results in smoothing, recontouring or enlarging is prohibited.

45.1.3 Parts must be used as furnished by General Motors. Alterations are not permitted except as specified herein.

45.1.4 Bore 3.771 max. This allows the use of .030 oversized dished pistons. Stroke 3.480 plus or minus .010.

45.1.5 Valves: Head diameter: Intake 1.720, Exhaust 1.500. Back cutting of the intake and exhaust valves up to the valve stem is permitted.

45.1.6 Cylinder Head - Any cylinder head that was supplied by General Motors on a 305 2 barrel motor with the correct valve size may be used. The minimum combustion chamber volume is 59cc. Angle milling is not permitted.

45.1.7 Any aftermarket cam may be used providing it meets OEM profile under these class rules.

45.1.8 Rocker Arms - Stock or stock replacement.

45.1.9 Pistons must be stock General Motors dished piston or TRW part #3028F or casting #454NP on side of pin boss. It is important to note that the pistons manufactured after 5/95 are being shipped with the dish "as cast." This means the dish area of the piston must be machined before the piston will meet the requirements of the rule. See drawing for dish dimensions. Pistons may be balanced and the dish machined, no other modifications will be allowed. The pistons listed above may be reversed.

In addition to the above-mentioned pistons, the following parts may be used.

J/E Piston Part #174002 Pin # 9272850-1551S: piston must be embossed with the APBA logo. Manley Part # 14112A8

Eagle Part # SIR5700BPLW Lunati Part # LHAF

Scat Part # 2ICR5700P

Scat Part # 3ICR5700P 34 Crower Part # SP91200

No changes or alterations can be made to these parts. This includes balancing.

- 45.1.10** Piston Rings - Must be of the type supplied by General Motors. The 1st and 2nd rings (compression) must be 1 piece design, .078 +.003 wide. 3rd ring (oil) must be 3 piece design, consisting of 2 rails and 1 expander.
- 45.1.11** Carburetors: Rochester OEM 2 Jet. Venturi size 1.190" max. Throttle plate size 1.688" max. Holley 2 bbl - part #4412, and alternate part #HP O-80583-1. No polishing or other modifications allowed, including the following parts:
- Accelerator pump.
 - Power valve (may not be removed).
 - Float assembly and float bowl (except adjustment of float lever).
 - Throttle plate, throttle shaft and screws.
 - Air horn.
- Holley replacement parts may be used that were designed and sold for the 4412 carburetor; and require no modifications for their use. Venturi dimension: 1.380" maximum, Throttle bore/plate dimension: 1.690" maximum, Throttle plate/shaft combined thickness dimension: 0.187" minimum. Booster - ID: 0.380" (+/- 0.03"), OD: 0.620" (+/- 0.10") Only the following metering blocks can be used, with no modifications allowed: Holley P/N 5924 / 5925 / 10570 / 12201. Manual choke mechanism may be removed and choke assembly holes plugged.
- OR** Carburetor/Spacer per rule 45.4.14 provided engine 45.1 with this option is declared prior to inspection.
- 45.1.12** Lifters - Stock or stock replacement. Solid lifters may be substituted for hydraulic lifters. No mushroom or roller lifters.
- 45.1.13** Valve Springs - Any valve spring may be used that fits the stock retainer. Spring retainer must be stock or stock replacement.
- 45.1.14** Intake Manifold stock 2 barrel cast part #346260, aluminum part #373598, the manifold may be milled on head mating surface and may be milled on carburetor mounting surface to compensate for engine angle
- OR** Intake manifold per rule 45.4.13 provided engine 45.1 with this option is declared prior to inspection.
- 45.1.15** Distributor - Any single fire electronic or points distributor that fits the engine without modification is permitted. Magneto crank triggered or multiple spark discharge systems are not permitted.
- 45.1.16** Flywheel - Any type - 11.000 min. diameter.
- 45.1.17** Camshaft sprockets, crankshaft sprockets and chain may be any "chain type." No belt or gear drives.
- 45.1.18** Fuel Pump - Any mechanical diaphragm type. No pressurized fuel tanks.
- 45.1.19** Oil Pump - Any General Motors oil pump that fits in the stock location without modification may be used. Oil pickup tube and bypass spring may be modified.
- 45.1.20** Push Rods - Stock or stock replacement.
- 45.1.21** Starter - Any starter that functions like the stock starter. No inertia starters.
- 45.1.22** Oil Pan - Any oil pan or baffles may be used. No dry sumps.
- 45.1.23** The following items may be of any manufacture: gaskets, spark plugs, wires, bearings, filters, fuel lines, hoses, fittings, valve covers, timing chain covers, breathers, nuts, bolts, washers, fittings and exhaust system.
- 45.1.24** The following machining procedures and parts are permitted:
- Engines may be clearanced. Rotating and reciprocating parts may be balanced. The block may be decked. Top of piston must be below the top surface of the compressed head gasket a minimum of .030. Intake and exhaust valve seats may be narrowed by cutting at 90 degrees or less, not to exceed 1" from combustion surface in bowl area on intake and exhaust side of seat. Inner intake seat diameter not to exceed 1.625. Intake and exhaust valve parts may not be altered in any way. Polylocks are permitted. Bronze wall valve guides are permitted. Valve guide seals are permitted. Push rod guide plates are permitted. Rocker arm studs may be pinned or screw in studs used. Cylinder walls may be sleeved. Water and oil passages may be blocked. Removal of air filter hold down in top of carburetor is permitted. A carburetor wedge may be used. Max thickness 1.000 with gaskets and spacer (exhaust gas diverter, commonly known as a spacer). A velocity stack or tube may be affixed to the carburetor. Valve spring seats may be machined.
- 45.1.25 Fuel. (See General Technical 40.18.12).**
- 45.1.26** The Inspector shall reserve the right to have any part or parts removed from the engine for inspection. Any parts in question must be sent to the chairman of the E 350 Technical Committee for review.
- 45.1.27** In the event that a record is established, the engine must be dismantled to determine legality of the parts. The valve train system will be checked using the following method. Engine builders are urged to use this same method as machining and part replacement can have an effect on valve lift and duration. Method for checking the camshaft profile and rocker arm ratio in the engine:
- Tools required: One 6" or 8" degree wheel attached to rotor button in distributor; one 500 thousandths travel dial indicator and a wire pointer.
- Inspectors note: If the engine to be inspected is using hydraulic lifters, the inspector should have in his list of inspection tools two solid lifters to use during this procedure.
- Procedure: Rotate engine in normal direction until the lifter is on the heel of the camshaft lobe. Set dial indicator on valve spring retainer. Adjust valve lash until dial indicator reads .001. Set dial indicator back to zero. Rotate engine in normal direction until dial indicator reads .050 stop. Set degree wheel to zero degrees or TDC mark on degree wheel. Rotate engine in normal direction and check every .050 thousandths lift. Read degrees on degree wheel.

	<u>Lift</u>	<u>Degrees</u>	<u>Lift</u>	<u>Degrees</u>	
s	.050	0.0	.050	0.0	s
	.100	6.0	.100	6.5	
	.150	12.0	.150	12.0	
opening	.200	17.0	.200	17.0	opening
ramp	.250	22.0	.250	22.0	ramp
	.300	28.0	.300	28.0	
	.350	35.0	.350	35.5	
	.400	46.5	.400	50.0	
t	.410	54.0	.402	53.0	t
stays open	.410	57.5	.402	56.0	stays open
s	.400	63.5	.400	58.0	s
	.350	74.5	.350	72.0	
	.300	81.0	.300	79.0	
closing	.250	87.0	.250	85.0	closing
ramp	.200	92.5	.200	90.0	ramp
	.150	97.5	.150	95.0	
	.100	103.0	.100	100.5	
E 350 305 GM MOTOR					
t	.050	110.0	.050	107.0	t

PISTON DISH DIMENSIONS

Maximum lift at valve - Exhaust .414 - intake .403

To check lobe spacing open exhaust valve to .250 thousandths lift. Set degree wheel to zero. Open intake valve to .250 thousandths lift. The degree wheel should read 116 degrees or 232 crankshaft degrees.

45.2 Ford Motor Company 302 Cu. In. Engine

45.2.1 The engine must be a Ford Motor Company V-8 302 cubic inch 2 barrel carburetor motor.

45.2.2 Grinding, polishing or blasting any internal part that results in smoothing, recontouring or enlarging is prohibited.

45.2.3 Parts must be used as furnished by Ford Motor Company. Alterations are not permitted except as specified herein.

45.2.4 Bore 4.065 max. This allows the use of 0.060" oversized flat top pistons. Stroke 3.000" ±0.010".

45.2.5 Valves: Head diameter - Intake 1.788 max., Exhaust 1.455 max. Back cutting of the intake and exhaust valves up to the valve stem is permitted.

45.2.6 Cylinder Head - Must be Ford Motor Company casting # E5AE CA or D8OE AB, with 1.788 intake and 1.455 exhaust. Minimum combustion volume is 69cc.

45.2.7 Camshafts - Any after market cam can be used providing it meets OEM profile under these class rules.

45.2.8 Rocker Arms - Stock or stock replacement.

45.2.9 Pistons - Must be stock cast flat tops with 4 valve reliefs or TRW # L2488 F may be used.

45.2.10 Piston Rings - Must be of the type supplied by Ford Motor Company. The 1st and 2nd rings (compression) must be 1 piece design, 3rd ring (oil) must be 3 piece design consisting of 2 rails and 1 expander.

45.2.11 Carburetor - Holley 2 barrel #0-4412 or HP 0-80583-1. No polishing or other modifications allowed, including the following parts:

- Accelerator pump.
- Power valve (may not be removed).
- Float assembly and float bowl (except adjustment of float lever).
- Throttle plate, throttle shaft and screws.
- Air horn.

Holley replacement parts may be used that were designed and sold for the 4412 carburetor; and require no modifications for their use. Venturi dimension: 1.380" maximum, Throttle bore/plate dimension: 1.690" maximum, Throttle plate/shaft combined thickness dimension: 0.187" minimum. Booster - ID: 0.380" (+/- 0.03"), OD: 0.620" (+/- 0.10") Only the following metering blocks can be used, with no modifications allowed: Holley P/N 5924 / 5925 / 10570 / 12201. Manual choke mechanism may be removed and choke assembly holes plugged.

OR

Carburetor/Spacer per **rule 45.4.14**

45.2.12 Lifters - Stock or stock replacement. Solid lifters may be substituted for hydraulic lifters. No mushroom or roller lifters.

45.2.13 Valve Springs - Any valve spring may be used that fits the stock retainer. Spring retainer must be stock or stock replacement.

45.2.14 Intake Manifold - Stock cast iron or aluminum 2 barrel. The intake manifold may be milled on the head mating surface. **OR** Edelbrock 7121 dual plane aluminum intake manifold is allowed. Cooling bleed lines allowed. Any evidence of sanding, polishing, relieving,

grinding, porting, chemical treating, abrasive blasting, ceramic work, addition of material or any alteration and modification of the original form is prohibited.

- 45.2.15** Distributor - Any single fire electronic or points distributor that fits the engine without modification is permitted. Magneto, crank triggered or multiple spark discharge system are not permitted.
- 45.2.16** Flywheel - Any type - 11.000 min. diameter.
- 45.2.17** Camshaft sprockets, crankshaft sprockets and chain may be any "chain type." No belt or gear drives.
- 45.2.18** Fuel Pump - Any mechanical diaphragm type. No pressurized fuel tanks.
- 45.2.19** Oil Pump - Any Ford Motor Company oil pump that fits in the stock location without modification may be used. Oil pick-up tube and bypass spring may be modified.
- 45.2.20** Push Rods - Stock, replacement or after market adjustable.
- 45.2.21** Starter - Any starter that functions like the stock starter. No inertia starters.
- 45.2.22** Oil Pan - Any oil pan or baffles may be used. No dry sumps.
- 45.2.23** The following items may be of any manufacture: gaskets, spark plugs, wires, bearings, filters, fuel lines, hoses, fittings, valve covers, timing chain covers, breathers, nuts, bolts, washers, fittings and exhaust system.
- 45.2.24** The following machining procedures and parts are permitted:
Engines may be clearanced. Rotating and reciprocating parts may be balanced. The block may be decked. Top of piston must be below the top of the block 0.005" minimum. Intake and exhaust valve seats may be narrowed by cutting at 90 degrees or less, not to exceed 1" from the combustion surface in bowl area on intake and exhaust side of seat. Intake and exhaust valve parts may not be altered in any other way. Bronze wall valve guides are permitted. Valve guide seals are permitted. Push rod guide plates are permitted. Rocker arm studs may be pinned or screw in studs used. Cylinder walls may be sleeved. Water and oil passages may be blocked. Removal of air filter hold down in top of carburetor is permitted. A carburetor wedge may be used. Max. thickness 1.000" including gaskets and spacer. A velocity stack or tube may be affixed to the carburetor. Valve spring seats may be machined.
- 45.2.25 Fuel. (See General Technical 40.18.12).**
- 45.2.26** The Inspector shall reserve the right to have any part or parts removed from the engine for inspection. Any parts in question must be sent to the chairman of the E 350 Technical Committee for review.
- 45.2.27** In the event that a record is established, the engine must be dismantled to determine legality of the parts. The valve train system will be checked using the following method. Engine builders are urged to use the same method, as machining and part replacement can have an effect on valve lift and duration. Method for checking the camshaft profile and rocker arm ratio in the engine:
- Tools required: One 6" or 8" degree wheel attached to rotor button in the distributor; one 500 thousandths travel dial indicator and a wire pointer.
- Inspectors note:** If the engine to be inspected is using hydraulic lifters, the inspector should have among his inspection tools two solid lifters and two adjustable push rods.
- Procedure: Rotate engine in normal direction until the lifter is on the heel of the camshaft lobe. Set dial indicator on valve spring retainer. Adjust valve lash until dial indicator reads .001. Set dial indicator back to zero. Rotate engine in normal direction until indicator reads .050 stop. Set degree wheel to zero degrees or TDC mark on degree wheel. Rotate engine in normal direction and check every .050 thousandths lift. Read degrees on degree wheel.

	Exhaust Lobe		Intake Lobe		
	<u>Lift</u>	<u>Degrees</u>	<u>Lift</u>	<u>Degrees</u>	
s	.050	0.0	.050	0.0	s
	.100	7.0	.100	6.0	
	.150	13.0	.150	11.0	
opening	.200	19.0	.200	16.0	opening
ramp	.250	25.0	.250	21.0	ramp
	.300	30.0	.300	26.0	
	.350	37.0	.350	32.0	
	.400	45.0	.400	41.0	
<u>t</u>	.440	62.0	.431	53.0	<u>t</u>
s	.440	64.0	.431	56.0	s
	.400	77.0	.400	68.0	
	.350	85.0	.350	76.0	
	.300	91.0	.300	83.0	
closing	.250	96.0	.250	88.0	closing
ramp	.200	101.0	.200	93.0	ramp
	.150	106.0	.150	97.0	
	.100	111.0	.100	103.0	
t	.050	118.0	.050	109.0	t

- Maximum lift at valve - Exhaust .440 - intake .431

To check lobe spacing open exhaust valve to .250 thousandth lift. Set degree wheel to zero. Open intake valve to .250 thousandths lift. The degree wheel should read 118 degrees or 236 crankshaft degrees.

45.3 General Motors 350 cubic inch engine

Below are the engine rules for the 350 engine option, stating specifically what is allowed for its use. Any modification or components not listed

below are not allowed.

- 45.3.1 Engine parameters:** Maximum displacement - 358 cubic inches, Compression ratio – 9.19:1 (+ 0.1 or 9.29:1 Max)
- 45.3.2 Block:** Stock cast iron production GM V-8 style block with standard external measurements only, no V-6 or 4 cylinder blocks allowed. Identification numbers may not be removed. No grinding or lighting allowed.
- 45.3.3** A maximum of three cylinder bores and/or a maximum of seven lifter bores may be sleeved. (No indexing lifter bores)
- 45.3.4** Only aftermarket engine block permitted: Dart SHP P/N: 31161111.
- 45.3.5 Crankshaft:** Steel magnetic crankshafts only, minimum weight: 50 lbs. including balancing. Unaltered in any way except for normal cleanup and balancing. May not be contoured or sculptured. Stock aftermarket “as cast” (over the counter) “knife edge” from major manufacturer is allowed. No modifications after purchase allowed. Stroke: 3.480” ±0.010”. Stock main journal (2.4450”) and rod journal (2.100”) sizes only (undercut maximum: 0.030”).
- 45.3.6 Connecting Rods:** Any large journal magnetic steel type connecting rods only. Maximum length: 5.700” ± 0.010”. Minimum weight: 600 grams including cap, bolts, and/or nuts. Must use full floating pins. No titanium or aluminum rods.
- 45.3.7 Pistons:** Any piston may be used. Pistons must remain in stock configuration. Piston skirt must be a full round. No FSR style pistons. No portion of the piston may protrude above the top of the block (measurement excludes head gaskets). No gas porting of piston ring lands and no top of piston coating of any kind. Ring lands must remain in standard location. Minimum distance between top of piston and top of first ring (compression): 0.180”. The weight of each piston should not be less than 590 grams including the wrist pin and “C” clips and rings. Maximum size over standard piston allowed (0.040”).
- 45.3.8 Piston Rings:** Must be of the type supplied by General Motors. The 1st and 2nd rings (compression) must be 1 piece design, 3rd ring (oil) must be 3 pieces design, consisting of 2 rails and 1 expander. Moly file fit rings allowed. Minimum thickness of rings 1/16” for top and second, 3/16” for oil control ring. No gapless rings allowed.
- 45.3.8.1 Options 1 Camshaft:** Purchase and/or alteration must be done through the APBA Inboard office (586) 773-9700 or Regates de Valleyfield committee. Michel Pourier (450) 371-6144 ext. 223. During the inspection process the maximum valve lifts are as follows: Intake: 0.467” Exhaust: 0.480”.
- 45.3.8.2 Option 2:** Comp Cams part # 12-675-4 .
- 45.3.9 Valvetrain:** Stock diameter magnetic steel hydraulic or solid flat tappets with a maximum diameter of 0.842”. Stock sized push rods only. Size 5/16” all the way (no titanium or exotic material). No mushroom or roller tappets. No rev kits. Double roller or standard timing chain only, no gear drive or belt drive systems. Roller rocker arms allowed. No shaft rocker arm systems. 1.50 Ratio only. Stud girdles allowed. Valve Springs - Any valve. spring may be used, maximum diameter: 1.250” (±0.010”). Spring retainer: Steel only, no exotic material. Standard diameter cam bearing only, no cam roller bearing allowed.
- 45.3.10 Head:** The only allowable head for use is Dart Part #:10021070 Dart Iron Eagle S/S 165. Heads must remain unaltered in any way except for flat milling of deck. (No angle milling allowed). Machining outer edge of valve guide for smaller valve seals and bronze liner allowed. Combustion chamber, intake and exhaust ports must be in the original ‘as cast’ configuration. Minimum volume of the combustion chamber: 64 cc. Head intake runner volume: 175cc (± 2cc). Head exhaust runner volume: 70cc. (± 2cc). Valves must be in stock location and at stock angle. Screw in studs (maximum size 0.4375”) and guide plates allowed. No gasket matching. Any evidence of sanding, polishing, relieving, grinding, porting, chemical treating, ceramic work, abrasive blasting, and alteration of the original form or the addition of material to the ports or combustion chambers are prohibited. Dart Iron Eagle S/S 165 tech sheet will be used for thorough inspection. Also allowed is DART Part#: 10021171. On this head, decking allowed only to reduce combustion chamber or flatten as needed to 64cc minimum. No other changes allowed.
- 45.3.10.1 Gasket/Port Matching** It shall be permissible to perform a minor port match on the intake ports of the heads and intake manifold at the flange mating surface of each if a minimum hull weight of 1,700lbs with driver is met. The heads shall meet rule 45.3.10 in its entirety other than this modification. The intake shall meet rule 45.3.12 in its entirety other than this modification. Dimensions shall be as follows:
- Maximum width to the outside wall of both ports shall be 2.70”
 - Maximum width of each port wall to wall shall be 1.25” each
 - Minimum width of port dividing wall shall be .200”
 - Maximum height of each port shall be 1.975”
 - Maximum port intrusion measured from the flange face of heads/intake shall be .625”
 - Maximum Intake port volume will be 178cc
 - There will be no tolerance to the above max/min measurements
- 45.3.11 Valves:** Any manufacturer may be used, no titanium or exotic material. Seat angle must be 45 degrees. Swirl polish allowed. Maximum exhaust diameter: 1.500” with a minimum stem diameter of 0.340”. Maximum intake diameter: 1.940” with a minimum stem diameter of 0.340”. Valve stem must remain the same size all the way. No back-cut allowed.
- 45.3.11.1 Valve Modification** - It shall be permissible to back cut valves that meet rule 45.3.11 above in its entirety if a minimum hull weight of 1,700lbs with driver is met. The maximum distance of the required 45* seat angle and the back cut may not exceed more than .250” as measured from the edge of the valve.
- 45.3.12 Intake Manifold:** Only an Edelbrock 7101 dual plane aluminum intake manifold is allowed. Cooling bleed lines allowed. Any evidence of sanding, polishing, relieving, grinding, porting, chemical treating, abrasive blasting, ceramic work, addition of material or any alteration and modification of the original form is prohibited.
- 45.3.13 Carburetor/Spacer:** Holley 4412 carburetor or Holley HP #80583-1 allowed. Venturi size: 1.375“, Throttle bore: 1.687“. The carburetor must pass top and bottom dimension tool specs. Choke plate may be removed but no removal of choke housing. No other visible modifications allowed on or inside the carburetor. Standard boosters only and must be tightly mounted. No annular boosters. Epoxying or safety wiring of boosters recommended. No vacuum leaks. No turtles or other induction performance enhancing devices. No other systems allowed. The use of two return springs is mandatory. An over-center throttle stop is recommended. Carburetor adapter (Spacer) Bicknell #376 (Max.1.00”) only, no modification allowed to adapter except for attaching hardware such as a throttle

bracket. An additional maximum size thickness straight bore spacer of 1.00” may also be used. Maximum of 3 gaskets for a total thickness of 0.266” allowed.

45.3.14 Method for checking the camshaft profile for the 350 cam:

- **Tools required:** One 6” or 8” degree wheel attached to rotor button in the distributor; one 500 thousandths travel dial indicator and a wire pointer.
- **Procedure:** Rotate engine in normal direction until the lifter is on the heel of the camshaft lobe. Set dial indicator on valve spring retainer. Adjust valve lash until dial indicator reads .001. Set dial indicator back to zero. Rotate engine in normal direction until indicator reads .050 stop. Set degree wheel to zero degrees or TDC mark on degree wheel. Rotate engine in normal direction and check every .050 thousandths lift. Read degrees on degree wheel.
- **Lobe separation:** Comp Cam: 110° ACHA Cam: 112°

Inspectors note: If the engine to be inspected is using hydraulic lifters, the inspector should have among his inspection tools two solid lifters and two adjustable push rods.

EXHAUST	COMP	ACHA	INTAKE	COMP	ACHA		
.050	0	0	.050	0	0		
.100	6	5.5	.100	6	5		
.150	11	10.5	.150	11	10		
.200	16	15.5	.200	16	15		
.250	21	20	.250	20.5	19.5		
.300	26	25	.300	25.5	24.5		
.350	31	30.5	.350	30.5	30.5		
.400	37	37	.400	37	37.5		
.450	44.5	47	.450	45	49.5		
.488*	51	.471**	59.5	.477*	51	.458**	57.5
.450	77	72	.450	73	66		
.400	85	81	.400	81	77.5		
.350	91	87.5	.350	87.5	84		
.300	96	93	.300	92.5	89.5		
.250	101	98	.250	97	94.5		
.200	105.5	103	.200	102	99		
.150	110.5	108	.150	107	104		
.100	115.5	113	.100	112	109		
.050	122	119	.050	118.5	114.5		

*Measured Max lift and degree of Comp Cam

** Measured Max lift and degree of ACHA Cam

45.3.15 Ignition: Any factory stock HEI type ignition only. No crank triggers. No external super coils. No aftermarket multiple spark discharge control boxes. Firing order must remain stock GM: 1.8.4.3.6.5.7.2.

45.3.16 Oil system: Aftermarket oil pans and breather allowed. Wet sump Oil pump must remain in stock location. Dry sumps allowed. Maximum three stages only. Oil coolers allowed ‘Aeroquip’ type oil lines only.

45.3.17 Fuel: See General Technical 40.18.12, a. through e. only allowed.

45.3.18 Fuel & Oil lines: Fuel lines must mount in a position to reduce damage, usually on front side of pump. No fuel lines shall pass through the driver’s compartment. No plastic fuel filters. No plastic pressure lines - No pressurized fuel tanks. Any type of fuel pump is allowed.

45.3.19 Miscellaneous: The following items may be of any manufacture: gaskets, spark plugs, wires, bearings, filters, fuel lines, hoses, fittings, valve covers, breathers, nuts, bolts, washers, fittings and exhaust system unless specified in these rules.

45.4 General Motors 305 cubic inch engine - Modified

Below are the engine rules for the 305 - Modified engine option, stating specifically what is allowed for its use. Any modification or components not listed below are not allowed.

The word “stock” as used in these rules is understood to mean the part in question will be used as it was supplied to the general public by the original motor manufacturer. The term “stock replacement” is understood to mean the part is sold to the public as a direct replacement for a stock part, without modification. Its marketed purpose must be for use in rebuilding an engine to stock specifications; not to increase power. The intent of stock replacement parts being included in these rules is to keep cost down and allow the use of readily available parts. No titanium parts are permitted.

45.4.1 Maximum displacement - 313 cubic inches

45.4.2 Block: The engine must be a General Motors V-8 305 Cubic Inch 4 barrel carburetor motor. Grinding, polishing or blasting any internal part that results in smoothing, recontouring or enlarging is prohibited. Parts must be used as furnished by General Motors. Alterations are not permitted except as specified herein. Bore 3.781” max. This allows the use of .040” oversized dished pistons. Stroke 3.480” plus or minus .010. Block may be bored, honed, align bored, deburred and resurfaced in order to achieve the desired deck height or protrusion of the pistons. The block may be decked. Top of piston must be below the top surface of the compressed head gasket a minimum of .030”. Deburring is not to be confused with grinding/polishing. Grinding and polishing are prohibited.

For the purpose of salvaging a damaged cylinder block, a maximum of four cylinders and/or a maximum of four lifter bores may be sleeved. Engines may be painted internally to enhance oil flow. External parts may be painted or chromed to enhance appearance. All unnecessary parts outside of the engine may be removed to permit installation into the boat. Water and Oil passages may be blocked, water passages may be modified. Lifter valley baffles, stand pipe and/or screens are permitted. Water and oil passages may be blocked.

- 45.4.5 Crankshaft:** Crankshaft main bearing journals and rod journals may be reground. Stock configuration of crankshaft counterweights must be maintained in the balancing process. Knife edging and chamfering of these weights are prohibited
- 45.4.6 Connecting Rods:** The following Big Journal I Beam press fit rods will be permitted: Manley Part # 14112A8
Eagle Part # SIR5700BPLW Lunati Part # LHAF
Scat Part # 2ICR5700P Scat Part # 3ICR5700P Crower Part # SP91200
- 45.4.7 Pistons:** Pistons must be stock General Motors dished piston or TRW part #3028F or casting #454NP on side of pin boss. It is important to note that the pistons manufactured after 5/95 are being shipped with the dish "as cast." This means the dish area of the piston must be machined before the piston will meet the requirements of the rule. See drawing for dish dimensions. Pistons may be balanced and the dish machined, no other modifications will be allowed. The pistons listed above may be reversed. In addition to the above-mentioned pistons, the following parts may be used. J/E Piston Part #174002 Pin # 9272850-1551S: piston must be embossed with the APBA logo. No changes or alterations can be made to these parts. This includes balancing.
- 45.4.8 Piston Rings:** Must be of the type supplied by General Motors. The 1st and 2nd rings (compression) must be 1 piece design, .078" +.003" wide. 3rd ring (oil) must be 3 piece design, consisting of 2 rails and 1 expander.
- 45.4.9 Camshaft:** Only Crane Cam part #: 113941. Maximum valve lift intake 0.454. Exhaust 0.480 and Comp Cam #12-556-4 Maximum valve lift intake 0.462 and exhaust 0.480 allowed and must remain unaltered in any way. Maximum valve lift: intake: 0.454" Exhaust: 0.480"
- 45.4.10 Valvetrain:** Rocker Arms - Stock or Roller Rocker allowed. 1.50 ratio. Lifters - Stock or stock replacement. Solid lifters may be substituted for hydraulic lifters. No mushroom or roller lifters. Valve Springs - Any valve spring may be used that fits the stock 1.260" retainer. Spring retainer must be stock or stock replacement. Push Rods - Stock or stock replacement. Push rod length is non-inspect-able but must be steel or chrome moly and stock diameter. Camshaft sprockets, crankshaft sprockets and chain may be any "chain type." No belt or gear drives
- 45.4.11 Head:** Any cylinder head that was supplied by General Motors on a 305 2-barrel motor with the correct valve size may be used. The minimum combustion chamber volume is 59cc. Angle milling is not permitted. Cylinder heads may be flat milled in order to achieve allowable combustion chamber volume. Machining of valve seats and valves must meet class specifications as well as all components used in the head and valve train. Intake and exhaust valve seats may be narrowed by cutting at 90 degrees or less, not to exceed 1" from combustion surface in bowl area on intake and exhaust side of seat. Inner intake seat diameter not to exceed 1.625". Intake and exhaust valve parts may not be altered in any way. Polylocks are permitted. Bronze wall valve guides are permitted. Valve guide seals are permitted. Push rod guide plates are permitted. Rocker arm studs may be pinned or screw in studs used. Stud girdles allowed. Valve spring seats may be machined
- 45.4.12 Valves:** Intake valves: Ferrea # 5161-8 only. No modification allowed. Exhaust valves: Any stock or stock replacement steel valve may be used as long as the stock stem diameter is maintained throughout (no reduced diameter, undercut stems). Face angle: 45 degrees only. Intake and exhaust head diameter tolerance +/- 0.005" unless otherwise noted. Stainless steel valves may be used. Back cutting the valve (relief angle) is permissible. Titanium, hollow stem, or sodium filled valves are not permitted. Maximum size 1.500"
- 45.4.13 Intake Manifold:** Edelbrock # 7101 only, the manifold may be milled on head mating surface
- 45.4.14 Carburetor/Spacer:** Carburetor: Holley 4brl. 600 CFM # 0-4776C Venturii size: primary 1.250", secondary 1.312" Throttle bore: primary and secondary 1.562" No polishing or other modifications allowed, including the following parts:
- Accelerator pump.
 - Power valve (may not be removed).
 - Float assembly and float bowl (except adjustment of float lever).
 - Throttle plate, throttle shaft and screws.
 - Air horn.
- Only carburetor choke mechanism components may be removed. No machining to choke horn allowed. 1 One Canton spacer 1.000" # 85-160 may be used (no modifications allowed). An additional 1" maximum height straight bore spacer may be used which can be milled to compensate for engine angle. A maximum of 3 gaskets for a total thickness of 0.266" allowed. A velocity stack or tube may be affixed to the carburetor. Fuel Pump - Any mechanical diaphragm type. No pressurized fuel tanks.
- 45.4.15 Ignition:** Distributor - Any single fire electronic or points distributor that fits the engine without modification is permitted. Magneto crank triggered or multiple spark discharge systems are not permitted.
- 45.4.16 Oil system:** Oil pan, oil pump and oil pickup may be modified as necessary. Remote filter, oil cooler, and oil accumulator are permitted. One oil accumulator with two-quart maximum volume is permitted, connected by a single oil line. Oil Pump - Any General Motors oil pump that fits in the stock location without modification may be used. Oil pickup tube and bypass spring may be modified. Oil Pan - Any oil pan or baffles may be used. Wet sump oil pump must remain in stock location. Dry sumps allowed. Maximum 3 stages.
- 45.4.17 Fuel:** See General Technical 40.18.12, a. through e. only allowed.
- 45.4.18 Fuel & Oil lines:** Fuel lines must mount in a position to reduce damage, usually on front side of pump. No fuel lines shall pass through the driver's compartment. No plastic fuel filters. No plastic pressure lines - No pressurized fuel tanks.
- 45.4.19 Miscellaneous:** Flywheel - Any type - 11.000" min. diameter. Starter - Any starter that functions like the stock starter. No inertia starters. The following items may be of any manufacture: gaskets, spark plugs, wires, bearings, filters, fuel lines, hoses, fittings, valve covers, timing, chain covers, breathers, nuts, bolts, washers, fittings and exhaust system. Rotating and reciprocation components of the engine may be balanced. Total assembly may not be lightened in an effort to gain added performance. **General Motors LS – LM7 5.3 Liter Engine.** Engine must be a (1999 thru 2007) General Motors LS-LM7-5.3L/325cid-Cast Iron Block. Grinding, polishing, or blasting any internal part that results in smoothing, recontouring or enlarging is prohibited. Parts must be used as

furnished by General Motors. Alterations are not permitted except as specified herein.

- 45.4.3 Engine Parameters:** Maximum displacement: 328 cubic inches, Maximum Compression Ratio: 9.5:1
- 45.4.4 Block:** Must be a stock cast iron production General Motors V-8 style block. Aluminum versions of this block are not allowed. Casting Numbers: 12567392, 12567393, 12551358 only. Identification numbers may not be removed. No grinding or lightening allowed. Stock Bore: 3.780 in. Stroke: 3.622 in. Deck Ht: 9.230-9.240 in. Maximum Bore: 3.800 in. This allows the use of .020" oversized pistons. A maximum of three cylinders bores and/or a maximum of seven lifter bores may be sleeved (no indexing lifter bores)
- 45.4.5 Crankshaft:** Must be GM OEM cast iron, 24x reluctor wheel crankshaft or aftermarket replacement matching OEM specifications. Steel magnetic crankshafts only. Unaltered in any way except for normal cleanup and balancing. Keying or pinning of the crankshaft to avoid coupler slipping is allowed and recommended. May not be contoured or sculptured. Stock aftermarket "as cast" (over the counter) "knife edge" from major manufacturer is allowed. No modifications after purchase are allowed. MINIMUM Crankshaft Weight: 51Lbs including balancing
 - 45.4.5.1 OEM CRANKSHAFT SPECIFICATIONS:** 3.622 in. stroke. 3.550 in. main journal 2.100 rod journal.
- 45.5.1 Connecting Rods:** OEM: Powdered Metal, I-Beam shape. Rod Length must be: 6.098 in. Wrist Pin Bore: 0.944" Big End Bore: 2.2300". Aftermarket, forged I-beam or H-beam rods matching stock 6.098 in length allowed. MINIMUM Connecting Rod Weight: 595 grams including cap, bolts & nuts.
- 45.5.2 Pistons:** Any OEM style piston may be used as long as maximum compression ratio is not exceeded. Pistons must remain in stock configuration. Piston skirt must be a full round. No FSR style pistons. No portion of the piston may protrude above the top of the block (measurement excludes head gaskets). No gas porting of piston ring lands and no top of piston coating of any kind. Ring lands must remain in standard location. The weight of each piston should not be less than 590 grams including the wrist pin and "C" clips and rings. OEM Piston Specifications: Hypereutectic Cast Aluminum alloy; Dished top without valve reliefs .068" x 3.050"; Piston Volume +8cc; Wrist Pin (1999-2004): 0.9447 in., 0.9448 in. (Pressed) Wrist Pin (2005-2007) 0.9429 in., 0.9431 in. (Floating).
- 45.5.3 Piston Rings:** OEM Cylinder Bore: 3.779 in. (up to 0.020" overbore allowed) Top Ring: 1.5mm, must be one piece design Middle Ring: 1.5mm, must be one piece design Bottom Oil Rings: 3.0 mm, three-piece design consisting of two rails and one expander. Minimum distance from top of piston to first ring: .250" based on a .040 head gasket thickness.
- 45.5.4 Cylinder Heads:** Only OEM Aluminum Heads supplied by GM for the LM7 motor -1999 thru 2007 may be used. Casting Numbers: 862, 706. Combustion Chamber Volume: 61 cc Intake Port Shape: Cathedral Intake Runner Volume: 200cc Exhaust port Shape: Oval Exhaust Runner Volume: 70cc. Cylinder head: Must remain unaltered in any way except the following: only flat milling is allowed, and intake and exhaust valve seats may be reworked (valve job) but touching and/or altering the aluminum part of the bowl is prohibited.
- 45.5.5 Head Gasket:** Any stock or equivalent, stock replacement head gasket may be used.
- 45.4.6 Valves:** Must not be made of titanium or "exotic" materials. Intake Valve Head Diameter: 1.890 in. Stem dia. 0.313 "x 4.880" Exhaust Valve Head Diameter: 1.550 in. Stem dia. 0.313" x 4.920" Valve Angle: Single 15 Degrees, Seat angle must be 45 degrees. Swirl polish allowed. Valve stem must remain the same size all the way. No back-cut allowed.
- 45.4.7 Valve Train:**
 - 45.4.7.1** Rocker Arm Style: Diecast/Roller Fulcrum – Stock as furnished by GM. Rocker Arm Ratio: 1:7
 - 45.4.7.2** Valve Spring Style: BeeHive – Stock. Any stock or stock replacement valve springs, retainers, and keepers of OEM style may be used. No titanium or "exotic" materials allowed.
 - 45.4.7.3** Lifters: Only OEM Hydraulic Roller lifters or equivalent replacements allowed. Link Style: Plastic Lifter Tray Lifter Body Diameter: 0.842 in. Push Rod Length: 7.385 in.

- 45.4.8 Intake Manifold:** Must be Stock GM LS 1997– 2005 OEM # 25321788 molded plastic manifold: No alterations allowed to the intake runners, Fuel Injector holders, throttle body mount and sensors. No alterations allowed except the following: Exterior fins and gromets may be removed, vacuum ports may be plugged.
- 45.4.9 Throttle Body:** 78 mm maximum size allowed. OEM AC Delco, cable or drive-by-wire system. 78mm aftermarket replacement allowed. No porting or polishing allowed. Vacuum ports may be used as reference for fuel pressure regulator. Unused vacuum port ports may be plugged. Any aftermarket intake tube and/or air filter may be used in combination with the factory Mass Air Flow sensor. The inside diameter of the throttle body at opening must be 78mm.
- 45.4.10 Throttle Control**
- 45.4.10.1** 1999 thru 2002 OEM throttle bodies – Cable Operated
- 45.4.10.2** 2003 thru 2007 OEM throttle Bodies – Drive by Wire. The use of Throttle Actuated Control.
- 45.4.10.3** Modules: (TAC) and corresponding electronic throttle pedal and PCM is permitted. This system may be used as a standalone system or connected by means of a traditional throttle cable to actuate the electronic throttle pedal. This must be a matched system.
- 45.4.11 Exhaust System:** Any exhaust system/headers may be used.
- 45.4.11.1** O2 Sensors may be mounted at any location and are not limited in quantity.
- 45.4.12 Fuel System**
- 45.4.12.1** Fuel Injectors: GM part Number 12576341 (42lb) Fuel injectors must be 12 OHM resistance and have a flow rate of 756.0cc/min at 50-60 psi. (58psi recommended) Any OEM LS fuel injector may be used. Aftermarket Injectors are prohibited. Fuel Rail Bore 0.540 Intake Bore 0.540 no alterations allowed. Fuel Injectors must be one of the following OEM LS #: 17113698, 12533952, 12554271, 12555894, 12556154, 12482704, 12561462, 12576341, 12598646, 12613411, 12569113, 12580681, 12613412, 12609749, 12639221, 12613411. Adaptors may be used to fit different sized injectors into the stock manifold port. (LS injectors vary in length and diameter)
- 45.5.1.1** Fuel Rails: OEM Fuel rails or direct OEM replacement intended to operate at 50-60 psi are allowed.
- 45.5.1.2** Fuel Pumps: Any electronic fuel pump is allowed. Surge tanks, multiple fuel pumps and in-tank submerged fuel pumps are allowed.
- 45.5.1.3** Fuel Pressure Regulator: A fuel pressure regulator must be used. Fuel pressure must be between 50 psi – 60 psi. (58 psi recommended) Any fuel pressure regulator may be used in place of the OEM return line system.
- 45.5.1.4** Fuel Lines: Fuel lines must be mounted in a position to reduce damage. No fuel lines shall pass through the driver's compartment. No plastic fuel filters. No plastic pressure lines. Great care must be used in fuel line connections, junctions and bends.
- 45.5.2 Camshaft:** Comp Cams 54-777-11-NSR Drifter- Grind #: 294LSD14, Duration at .050 (Int/Exh.): 294/304, Lift (Int./Ex.): 0.541in, /0.541 in., Lobe Separation Angle (In degrees): 114, Cam gear attachment: 3 bolt, Camshaft sprockets, crankshaft sprockets and chain may be any "chain type." No belt or gear drives.
*NOTE: This camshaft requires no aftermarket valve springs.
- 45.5.3 Oil System:** Oil pan, pickup, and filter system may be altered to fit boat and incorporate baffles, windage tray and/or crankshaft wipers. Oil pan must remain a wet sump system. 'Aeroquip' type oil lines only for remote oil filters. Aftermarket Oil Pump for increased volume or pressure allowed.
- 45.5.4 Electrical System:** Engine to be controlled and run with any powertrain control module referred to as a PCM or ECU. Aftermarket PMS/ECUs are permitted and recommended for racing applications.

45.5.4.1 PCM/ECU: Haltech Rebel LS PCM/ECU Engine control system NOTE: “Tuning” of aftermarket PCM/ECU includes a wide array of adjustments such as ignition timing, fuel mixtures, injector timing, RPM limits, throttle position, idler speed. This list is not comprehensive. The intent of an aftermarket PCM/ECU system is not to give an advantage but to allow proper engine management to achieve optimal engine performance in racing conditions. A PCM/ECU is similar in comparison to ignition timing and carburetor jetting adjustments. The limiting factor for engine performance shall continue to be the intake of air to the engine through the throttle body, intake manifold, and camshaft. Adjustments to the “tune” (any of the parameters) of a PCM/ECU during a race shall not be permitted.

45.4.12.2 (OEM PCM/ECU OPTION) MFG: Delphi 1-mb Gen III - General Motors released several different hardware numbers to identify the 1-mb Gen III PCMs, but any of them can be used with an engine equipped with a 24x crank signal. PCM #'s: *09354896, *12200411 were used from 1997 – 2004 and have connectors with blue and red retainers. PCM #'s: *12589462, 12589463, *12602801, 12602802, 28042802 were used from 2005 – 2007 and have connectors with blue and green retainers. PCM with (*) will accept throttle cable throttle linkage all others require a TAC or drive by wire application. Wiring harness may be modified, or custom made to use any fuse/relay system to power the engine. Unused circuits into or out of the PCM may have the wire/pins removed but remaining pins must be in the factory locations; in other words, the pinout locations must remain as from the factory. Any sensor may be removed or disconnected but shall not be modified or altered to perform or record values in any other way other than OEM intended methods with the following exceptions: Downstream O2 sensors may be removed or may be “tricked” to report exhaust gases as if a catalytic converter were present. Output shaft speed sensor (transmission) may be mounted in such a way as to report a theoretical speed to the PCM thereby “tricking” the PCM into allowing the fuel injectors to actuate. The Output speed sensor may also be deleted as necessary and PCM programed to function without its input.

45.4.13 Recommended Minimum Inspection Procedure for GM LM7 5.3L motor

- 45.4.13.1** Check combustion chamber: Cylinder head chamber volume 42.0cc minimum. Flat portion of piston must be below gasket (installed on head) a minimum of 0.040”. Compressed head gasket thickness must be a minimum of 0.022”.
- 45.4.13.2** Check maximum cylinder bore allowance: (3.780” OEM), Maximum Bore: 3.810 in. This allows the use of .020” oversized pistons.
- 45.4.13.3** Check Rod length/engine stroke: Stroke: 3.622 in max, Rod Length: 6.1 in
- 45.4.13.4** Check piston ring height: Minimum distance from the top of the piston to the first ring: .250”
- 45.4.13.5** Check valve train: Valve sizes and face angle. Single 15 Degrees – no back cut allowed Intake Valve Head Diameter: 1.890 in. Stem dia.: 0.313 “x 4.880” Exhaust Valve Head Diameter: 1.550 in. Stem dia.: 0.313” x 4.920” Valve Angle: Single 15 Degrees – no back cut allowed

Check the camshaft. Tools required: One 6” or 8” degree wheel attached to the end of the crankshaft; one 500 thousandths travel dial indicator and a wire pointer. Lobe Separation Angle (In degrees): 114 Duration at 0.050 (Int/Exh.): 294/304: Using a Dial Indicator and Degree Wheel, find the opening and closing points of the valves at 0.050 in. of lift. If the intake valve opens AFTER TDC, use a negative value. If the exhaust valve closes BEFORE TDC, use a negative value. Add the numbers together. Add 180° to find duration. Lift (Int./Ex.): 0.541 in, /0.541 in. Procedure: Rotate engine in normal direction until the lifter is on the heel of the camshaft lobe. Set dial indicator on valve spring retainer. Rotate engine in normal direction until indicator reads .050 stop. Set degree wheel to zero degrees or TDC mark on degree wheel. Rotate engine in normal direction and check every .050 thousandths lift. Read degrees on degree wheel. Check all parts for any grinding, polishing and any other alterations from the furnished stock configuration. durability and power.

45.6 2.5 Modified Engine Option

45.6.1 A 2.5 Modified boat may also run in the E350 class if it meets the following requirements:

- **Minimum Weight: 1325 lbs**
- **Minimum length: 16 ft**
- **Minimum cubic inch displacement (CID): 155 cubic inches**
- **Maximum cubic inch displacement (CID): 166 cubic inches**

RULE 46 - NATIONAL MODIFIED CLASS

- 46.1** The National Modified class was formed by combining the 4 Litre Modified and 6 Litre classes. Any engine-to-propeller coupling; gear boxes permitted. Only one (1) underwater screw type propeller is permitted. Turbochargers and superchargers are prohibited. The only engines allowed are those of a push rod type, 2 valve per cylinder, camshaft in block, 4-cycle design.
- 46.2 Rudder Specifications:** Rudders must extend 3-1/2" below the bottom tip of the propeller. Thickness of the rudder shall be measured 2" below the rudder bracket. Thickness of the trailing edge dimension shall be measured from the top of the rudder blade to 2" below the rudder bracket.
- 46.2.1 Heat treated steel rudder:** Boats with engines over 246 c.i. must have a minimum 1/2" trailing edge. Boats with engines 246 c.i. or less must have a minimum 3/8" trailing edge.
- 46.2.2** Aluminum rudders must be a minimum of 1" at the trailing edge.
- 46.2.3** There shall be no tolerance below these dimensions.
Trailing edge dimension is required from the top of the rudder blade to 2" below the rudder bracket.
- 46.3 246 c.i. option (formerly 4 Litre Modified rules)**
Engine:
- 46.3.1** Maximum displacement is 246 c.i.
- 46.3.2** Cylinder heads and blocks must be available from an OEM published parts list. Such parts intended for production or "off-road" use will be allowed.
- 46.3.3** All parts, unless specified herein, may be modified at the discretion of the engine builder.
- 46.3.4** Any type camshaft, lifter or tappets may be used.
- 46.3.5** Any valve size may be used, but only 2 valves per cylinder will be permitted.
- 46.3.6** Carburetor: Any carburetor(s) up to a maximum of four (4) venturis and available on the open market may be used. Maximum throttle bore will not exceed 1.700" per bore on any combination of carburetors. Should a larger bore be used, a restrictor plate must be added between carburetor and manifold to reduce throttle bores to 1.700" maximum. Plate thickness must not exceed .750" (3/4").
- 46.3.7** No fuel or water injection allowed.
- 46.3.8** Fuel is restricted to gasoline only.
- 46.4 308c.i. option (formerly 6 Litre Modified rules)**
Engines:
- 46.4.1** 308c.i. engines must be sold in the United States as automotive or marine engine. Cast or aluminum blocks may be used.
- 46.4.2** Maximum displacement is 308c.i.
- 46.4.3** Engine modifications are unlimited.
- 46.4.4** Gasoline or methanol is permitted.
- 46.5 368c.i. option (formerly 6 Litre rules)**
Engines:
- 46.5.1** Engines must be GM, Ford, Chrysler manufactured with GM, Ford, Chrysler part number. World Products and Dart aftermarket cast iron blocks may be used in addition to OEM as long as they conform to OEM specs as to dimensions as purchased. All modifications allowed on OEM blocks shall be allowed on aftermarket blocks.
- 46.5.2** A maximum displacement is 368c.i. Fuel shall be restricted to gasoline only.
- 46.5.3** Any crankshaft or connecting rod is permitted. Any camshaft may be used. Double overhead cams are not allowed. Mushroom lifters and roller lifters are permitted.
- 46.5.4 Cylinder Heads**
- 46.5.4.1** Any cast iron cylinder head, as cast, available in U.S. market over the counter may be used, limited to 2 valves per cylinder. Porting and polishing is not permitted. No coatings or cover up of any kind allowed in the combustion chamber or ports. No additional machining beyond original specifications is permitted. Milling heads is permitted. Max intake valve size of 2.125 inches and maximum exhaust valve size of 1.710 is permitted. A port match of the intake opening of the cylinder head shall be allowed with a maximum intrusion of .625" from the manifold mounting face.
- 46.5.4.2** Brodix SP (CH,FO,MO) aluminum head, 2 valves per cylinder. Only a maximum intake valve diameter of 2.080 inches and a maximum exhaust valve diameter of 1.600 inches are permitted. Heads may be resurfaced but angle milling is prohibited
- 46.5.5** Any ignition, exhaust, fuel pump and oil pump system may be used.
- 46.5.6** The only carburetors permitted are a Holley 4-barrel, model #4776, HP 0-80540-1 or HP 0-80540-2, having a MAXIMUM 1.265 inch primary venturi, a MAXIMUM 1.3275 inch secondary venturi and a MAXIMUM 1.5675 inch throttle plate bore. There is NO tolerance to these measurements.
- 46.5.7** The use of aluminum cylinder heads and aluminum engine blocks will not be allowed in the 368c.i. alternate engine.
- 46.5.8** Intake manifolds may only be mass produced, over the counter cast type. After market brands are permitted.
- 46.6** A 2.5 MOD and an E350 are legal entries in the National Modified class. Excluded are hulls registered as a 2.5 Stock, S boat.

RULE 47 - GRAND NATIONAL HYDROPLANE CLASS

47.1 The objective of the rules for the Grand National Hydroplane Class are to promote and govern a professional class of propeller driven Inboard Racing Hydroplanes using high performance versions of readily available, big block (defined as having a cylinder bore spacing greater than

- 4.600”) automotive and marine engines with parts available over the counter or OEM and utilizing recognized manufacturer racing gasoline.
- 47.2 Hull, cavitation plates and drive shaft shall not be adjustable while boat is in motion. Propulsion will be by one underwater propeller. Said propeller shall be no more than three blades and must be of cast material.
- 47.3 It is mandatory that all Grand National Hydroplanes competing have two-way radio communications.
- 47.4 A minimum 1 hour is recommended between heats where the same boats compete. -
- 47.5 Fuel (See General Technical 40.18.12)

47.6 Engines

47.6.1 468 CID Engine Option 1

47.6.1.1 Engines are to be of U.S. manufacture, cast iron block, supplied by OEM, automotive or marine, 4 cycle, internal combustion type. Total cubic inches not to exceed 468. Engine must be normally aspirated utilizing any Holley 600 CFM carburetor with a throttle bore of 1-9/16 max. both primary and secondary. Ignition may be any type, except crank-driven. No overhead camshafts

47.5.1.2 Inspection Procedure: Length of hull, weight of hull, fuel check, cubic inches, carburetor size -

47.6.2 468 CID Engine Option 2

47.6.2.1 **Block:** Only cast iron OEM or aftermarket short deck blocks permitted.

47.6.2.2 The bore, stroke combination allowed will be: 4.310 x 4.00 (454 Chevy) or 4.440 x 3.760 (427 Chevy).

47.6.2.3 **Rods:** Stock length rods, 6.135 in.

47.6.2.4 **Carburetor:** Holley 4 barrel carburetor with throttle bore 2 inch max.

47.6.2.5 **Cams:** Roller cams may be used.

47.6.2.6 **Rocker arms:** Stock 1.7: 1 rocker arm ratio only. Roller rockers may be used.

47.6.2.7 **Valves:** Valve head diameter: Intake 2.300” max, Exhaust 1.900” max.

47.6.2.8 **Cylinder heads:** Only Chevrolet common wall intake cylinder heads allowed. No Brodix, Pontiac, Darts, etc.

47.6.2.9 No grinding or polishing of any kind in the intake ports, exhaust ports or combustion chambers.

47.6.2.10 The following are not inspectable: intake manifold, cam, compression ratio, piston and rings, carburetor body and venturi.

47.6.3 511 CID Engine Option 3

47.6.3.1 US manufacture, automotive or marine, 4 cycle internal combustion type cast iron blocks only.

47.6.3.2 Total cubic inches not to exceed 511.

47.6.3.3 Engine to be normally aspirated utilizing any American-made carburetor with a throttle bore as follows:

a. Primary: 1 9/16” maximum.

b. Secondary: 1 9/16” maximum.

c. A .250 inch thick restrictor plate, located a maximum distance of 1.5 inches below the carburetor, with these dimensions will be acceptable. These holes shall not be conical in shape; must be straight cut. Plate thickness shall include gaskets. All other adapters or spacers shall be included in the maximum distance.

47.6.3.4 Ignition may be of any type.

47.6.3.5 No overhead camshafts.

47.6.3.6 Two valves per cylinder maximum.

47.6.3.7 Cast intake manifold only. Must be available from a major manufacturer.

47.6.3.8 No symmetrical port heads permitted.

a. **Allowed:** common wall type including Chevrolet, Dart 320 and 360, Brodix -1, -2, -3, -4, and other non-symmetrical port cylinder heads.

b. **Not Allowed:** Pontiac Prostock, Dart Big Chief, Oldsmobile DRCE, Dart Oldsmobile, Brodix EPD, and other symmetrical port cylinder type heads.

47.6.3.9 In order to run this engine, the hull must weigh a minimum of 2,500 pounds excluding driver, and must be 20 feet minimum length and maximum length of 26 feet.

RULE 48 - GRAND PRIX HYDROPLANE CLASS

48.1 The Grand Prix class must follow all Inboard rules listed this rulebook, however, should the GP class members decide to participate in the GPA Series, the following rules will apply:

48.1.1 There will be no title event awarded (Eastern, Western, Summer National) for any GPA Series race.

48.1.2 No points will be earned at any other non-GPA Series event

48.1.3 This proposal will remain in effect for a period of five years (1/24/25-1/24/30) and will only be effective if there is a minimum of four (4) events. NO CHANGES TO THESE RULES ARE ALLOWED DURING THIS TIME PERIOD.

48.2 STARTING PROCEDURE:

48.2.1 QUALIFICATIONS AND TIME TRIALS

- 48.2.1.1 For time trials there will be a random draw to determine the order. For time trials, the Race Director will decide how many laps are to be done. Every lap will be timed but only the fastest lap time of the allotted laps will be considered as the official time.
- 48.2.1.2 Before the start of the race, boats must take their assigned lanes at the mid-course buoy on the back stretch and maintain their lane until the exit of turn one (1). If a boat is not in his lane due to a race incident on the course, it shall not be penalized if they do not take advantage of the situation.
- 48.2.1.3 In the first 2 qualification heats, the lane draws are determined by time trial position. For the third qualifier, the lanes will be determined by total points accumulated for the weekend. The boats with the lowest point total will be awarded the inside lane (Highest point total will be awarded the outside lane). The tie breaker will be the fastest time trial time. (See chart below)
- 48.2.1.4 A qualification shall be considered official provided that all the heats of the same qualification group have run.
- 48.2.1.5 The number of boats per heat is determined by the Race Director/ Chief Referee depending on the racecourse.

48.2.2 FINAL AND CONSOLATION

- 48.2.2.1 Boats starting in the second row (trailer) must start five (5) seconds after the official clock hits the 0:00 and must remain in their earned lane(s) throughout the first corner.
- 48.2.2.2 If a boat qualifies for the final based on total points and declares a DNS prior the launching, the field will be completed according to the result of the position of the consolation. Only the boats that made the consolation will be used to complete the group for the final. The choice of the boat(s) will be according to rule 48.2.2.4. If there is no consolation for a class, the group for the final will be completed according to the rule
- 48.2.2.3 However, in the case of a restart in the final where two (2) or more boats cannot make the restart, the Race Director and Chief Referee reserve the right to fill the field, and these boats will take the start on the outside lanes. Position for the final and consolation will be determined by the total accumulation of points from the qualifications and/or time trials. If there is a tie in total points, the best time of the qualifications will determine the standing. (If there is still a tie, a random draw will determine its standing. In the absence of time for a qualification for one or more groups, the time of this wave cannot be used to decide a tie.)
- 48.2.2.4 The number of boats in a final will be decided by the race director/ chief referee. The boats with the highest total of points per the weekend will go directly to the final. The winner of the consolation will qualify for the final in the outside lane. If there are 2 consolation heats, the 2 winners will qualify for the outer 2 lanes based on the consolation final time.
- 48.2.2.5 There will be only one final per class per event. The race director and the chief referee can decide to hold a final without having a consolation. The consolation will only be considered official if the final is declared official.
- 48.2.2.6 If no official time trial/ qualification is held during the weekend, there will be no final.
- 48.2.2.7 If a final cannot be presented, the final standings for the weekend will be determined by the number of points accumulated during the qualifications and/or the time trials. If there is a tie in the accumulation of points, the best time of the qualifications will determine the standings/winner. If the tiebreaker cannot be broken by fastest time trial time, the standings will remain as they are and there will be more than one boat in the same position.

48.2.3 Lane Assignment

Lane Assignment

		Q1			Q2			Q3				Q4								
2 Groups	Cr	1A	1B		Cr	2A	2B		Cr	3A	3B		Cr	4A	4B					
	1	1	2		1	16	15		1	15	16		1	16	15					
	2	3	4		2	13	14		2	13	14		2	13	14					
	3	5	6		3	12	11		3	11	12		3	12	11					
	4	7	8		4	9	10		4	9	10		4	9	10					
	5	9	10		5	8	7		5	7	8		5	8	7					
	6	11	12		6	5	6		6	5	6		6	5	6					
	7	13	14		7	4	3		7	3	4		7	4	3					
	8	15	16		8	1	2		8	1	2		8	1	2					
3 Groups	Cr	1A	1B	1C	Cr	2A	2B	2C	Cr	3A	3B	3C	Cr	4A	4B	4C				
	1	1	2	3	1	23	24	22	1	22	23	24	1	23	24	22				
	2	4	5	6	2	19	20	21	2	19	20	21	2	19	20	21				
	3	7	8	9	3	18	16	17	3	16	17	18	3	18	16	17				
	4	10	11	12	4	14	15	13	4	13	14	15	4	14	15	13				
	5	13	14	15	5	10	11	12	5	10	11	12	5	10	11	12				
	6	16	17	18	6	9	7	8	6	7	8	9	6	9	7	8				
	7	19	20	21	7	5	6	4	7	4	5	6	7	5	6	4				
	8	22	23	24	8	1	2	3	8	1	2	3	8	1	2	3				
4 Groups	Cr	1A	1B	1C	1D	Cr	2A	2B	2C	2D	Cr	3A	3B	3C	3D	Cr	4A	4B	4C	4D
	1	1	2	3	4	1	32	29	30	31	1	29	30	31	32	1	32	29	30	31
	2	5	6	7	8	2	27	28	25	26	2	25	26	27	28	2	27	28	25	26
	3	9	10	11	12	3	22	23	24	21	3	21	22	23	24	3	22	23	24	21
	4	13	14	15	16	4	17	18	19	20	4	17	18	19	20	4	17	18	19	20
	5	17	18	19	20	5	16	13	14	15	5	13	14	15	16	5	16	13	14	15
	6	21	22	23	24	6	11	12	9	10	6	9	10	11	12	6	11	12	9	10
	7	25	26	27	28	7	6	7	8	5	7	5	6	7	8	7	6	7	8	5
	8	29	30	31	32	8	1	2	3	4	8	1	2	3	4	8	1	2	3	4

48.2.4 Point distribution Chart

Positions	Essais Chronométrés Time Trials ***	Qualifications	Consolations	Finale/ Final A	Finale/ Final B
1	25	25	Accès à la finale	25	7
2	25	21	7	21	6
3	21	18	6	18	5
4	21	15	5	15	4
5	18	13	4	13	3
6	18	11	3	11	2
7	15	9	2	9	1
8	15	8	1	8	1
DNS/DNF/DNQ	0	0	0	0	0

DNS: Did not start DNF:

Did not finish

DNQ: Did not qualify or Disqualified

48.2.5 High point champion will be determined using the above points system

48.3 For safety reasons, boats may cross the starting line before the last thirty (30) seconds prior to the official start of the race. All boats crossing the starting line during the last thirty (30) seconds before the official start will be assessed a one (1) minute penalty. Prior to the start of the race, lanes must be established at the entrance pin of turn two and maintained to the exit buoy of turn one after the start.

48.4 Boat high points may be transferred to a team backup boat. The backup boat must have the same name and number. A boat owner may accumulate points with only one boat per event.

48.5 The consumption or use of any alcohol in the working paddock or pits shall be expressly prohibited until 30 minutes after the last heat of the day or inspection is completed, whichever is later. Specifically, drivers shall not consume alcohol in any form during the twelve (12) hour period immediately prior to the start of an event. The boat owner shall be directly responsible for the conduct of any and all members of his crew.

48.6 Conduct of races (Recommended Format)

48.6.1 Time trials or up to 3 qualification heats, semi final (time permitting), and a final. The race committee has the option of competing or drawing for lanes. The method will be announced at driver's meeting.

48.7 Hull

48.7.1 The hulls in the GP class must be hydroplanes; runabout hulls are not acceptable. Maximum length shall be 26 feet including projections. Hull minimum weight shall be 2,700 pounds without driver.

48.7.1.1 Hulls built prior to Dec 31, 2007 shall have a minimum length of 23 feet excluding projections not an integral part of the hull structure. Maximum width is 12' 9".

48.7.1.2 Hulls built or rebuilt after Dec 31, 2007 have a minimum length of 24 feet excluding projections not integral part of the hull structure. Maximum width is 12' 6".

48.7.1.3 Hulls completed prior to January 2010 may have a maximum length of 26' 8" excluding projections not an integral part of the hull structure.

48.7.2 All Grand Prix boats must have a reinforced type 4 or F16 style cockpit built to APBA/CBF specifications.

48.7.3 Gear boxes are allowed but multiple speed gear boxes are not permitted.

48.7.4 Hardware requirements: see rule 3.8.

48.7.5 Cavitation plates and drive shafts shall not be adjustable while boat is underway; however, wings may be. Propulsion must be by one underwater propeller. Outdrives are not allowed.

48.7.6 All Grand Prix boats shall be equipped with functional on-board pressurized fire suppression system charged with a minimum of 5 pounds (minimum of 10 pounds recommended) of Dupont FE-36 or equivalent, with distribution nozzles in the engine compartment. The system shall be inspected as specified by SFI spec. 17.1.

48.7.7 Two-way radio communications are mandatory. Frequency checks shall be reviewed at the driver's meeting to determine conflicting or overlapping channels.

48.7.8 A strobe light is mandatory. A fine will be imposed if a competing hull does not have one.

48.8 Engine

48.8.1 Engines shall be automotive or marine using cast iron blocks, 4 cycle, 2 valves per cylinder, internal combustion type. Aftermarket blocks are allowed. Maximum displacement is not to exceed 468 cubic inches. No titanium engine components with the exception of valve spring retainers and keepers. Any valve spring retainer and keeper may be used. No overhead camshafts. Any type ignition system is allowed. All engines must be equipped with a means to shut off the fuel supply in the event of an emergency. Electric fuel pumps shall have a switch located in the cockpit within the drivers reach or some positive method to kill the fuel pump when the engine stops. Electric fuel pumps must also have an external power shut off outside of hull for safety reasons. Manual fuel pumps shall have a manual shut off device located in the cockpit within the drivers reach.

48.8.2 **Fuel:** Methanol or gasoline. No nitro methane, nitrous oxide or other power producing additives are allowed.

48.8.3 Data Acquisition: On board data acquisition is allowed. No outside telemetry or modifications from shore are allowed during a race.

48.8.4 ENGINE OPTION ONE:

- 48.8.4.1 Unless noted otherwise, all technical dimensions are to be measured with plus or minus .010" tolerance.
- 48.8.4.2 No intercoolers allowed EXCEPT GASOLINE FUELED MOTORS ONLY.
- 48.8.4.3 **Static compression:** 9.5:1 maximum
- 48.8.4.4 **Block:** Any manufacturer, cast iron.
- 48.8.4.5 **Connecting rods:** Any type or manufacturer.
- 48.8.4.6 **Pistons:** Any type or manufacturer.
- 48.8.4.7 **Rings:** Any type or manufacturer.
- 48.8.4.8 **Supercharger:** Must be a 6-71 standard roots type design, 60-degree helix rotors only. No Screw Style superchargers. Superchargers are to be driven at no more than 120% of crankshaft speed. Inspect blower pulley drive ratio for the first 2 places in each final heat. No magnesium or titanium cases or rotors allowed. Rotors must be a maximum of 15.00 inches in length. Cast or billet rotors are allowed, 5.860 inch maximum rotor diameter. No "Hi-Helix" rotors are allowed.
- 48.8.4.9 **Fuel System:** Fuel may be metered by carburetors or a mechanical fuel injection system. Fuel injection systems must be injected by hat nozzles using a cast, billet, or composite injector hat available from a major manufacturer. Port injection is permitted but not mandatory. No electronic fuel injection systems are permitted unless probationary equipment procedure is requested.
- 48.8.4.10 **Heads:** Symmetrical port cylinder heads are NOT permitted. Allowed: Common wall type aluminum or cast iron including Chevrolet, Dart common wall types, Brodix 1, 2, 3, 4 and other non-symmetrical port cylinder heads. Not Allowed: Pontiac Pro Stock, Dart Big Chief, Olds DRCE, Dart Olds, and Brodix EPD.
- 48.8.4.11 **Valve Springs:** Any type and any manufacturer may be used.
- 48.8.4.12 **Valves:** Any manufacturer may be used. No carbon wound, or ceramic material.
- 48.8.4.13 **Camshaft:** Any camshaft may be used.
- 48.8.4.14 **Rocker Arms:** Any rocker or roller rocker may be used.
- 48.8.4.15 **Push Rods:** Any push rod may be used.
- 48.8.4.16 **Cam Drive:** Any timing chain, belt or gear drive may be used.
- 48.8.4.17 **Intake Manifold:** Any manufacturer cast aluminum may be used. No handmade fabricated manifold. Two piece manifolds which consist of a cast base and an adaptor plate may be used as long as the adaptor plate is less than one inch thick. The adaptor plate may be constructed of cast or extruded aluminum.
- 48.8.4.18 **Oil Pan:** Any oil pan may be used.
- 48.8.4.19 **Dry sump:** Any dry sump may be used.

48.8.5 ENGINE OPTION TWO:

All requirements of Engine Option One shall apply except for the following:

- 48.8.5.1 **Supercharger:** Must be an 8-71 standard roots type design, 60 degree helix rotors only. No Screw Style superchargers. Superchargers are to be driven at no more than 120% of crankshaft speed. Inspect blower pulley drive ratio for the first 2 places in each final heat. No magnesium cases or rotors. Rotors must be a maximum of 16.00 inches in length. Cast or billet rotors are allowed, 5.860 inch maximum rotor diameter. No "Hi-Helix" rotors are allowed. Only one (1) gasket is permitted between the base of the supercharger and the intake manifold. No spacer plates, intercoolers, aftercoolers or chillers, etc. allowed except intercoolers will be allowed for GASOLINE FUELED MOTORS ONLY.
- 48.8.5.2 **Heads:** Dart BBC Pro1 24° 355cc CNC heads are the only heads allowed for this engine option. CNC production heads (P/N 19574030) purchased directly from Dart do not require the Valleyfield logo to be stamped on them. Repairs to the head are permitted but they must be certified by Dart and have the new spec sheet from DART.
- 48.8.5.3 **Valves:** Any valve may be used except the valves must be configured to fit the Dart BBC Pro1 24° 355cc CNC heads.
- 48.8.5.4 **Camshaft:** Any camshaft may be used except maximum valve lift of 0.680"; to be measured at the valve retainer.
- 48.8.5.5 **Static compression:** 9.5:1 maximum.

RULE 49 - JERSEY SPEED SKIFF CLASS

- 49.1 The Jersey Speed Skiff Class is a special class of Inboard Runabouts, required to fall within the limitations of the following rules:
 - 49.1.1 In competition, the boat must carry a crew of two (2), seated side by side, aft of the engine.
 - 49.1.2 The minimum weight of the boat complete in racing trim without crew, jacket, helmets, lifting slings or fuel shall be 1,650 pounds.
 - 49.1.3 Wood hulls shall be lapstrake with a minimum of six (6) planks per side, beginning from flat bottom. Wooden hulls shall have steam-bent ribs, copper riveted on six (6) inch centers or less. Boats made of materials other than wood shall conform to the measurements and appearance as if such boats were made of wood, ribs excepted.
 - 49.1.3.1 As of June 01, 2010 all Jersey Speed Skiffs must have the nose area of the boat foamed in order to participate in an APBA sanctioned event. The area must be foamed with a 2 pound density, marine flotation foam starting at the stem, following the deck line, going back a minimum of 30 inches and be at the height of the new bulkhead. To add the necessary strength and support the foam, a half bulkhead must be installed at this point. This bulkhead must be a minimum 1/4 inch thick, fitted to the sides and be no less than 14 inches up from the inside bottom/floor of the boat. The bulkhead is to be secured in an equal or superior method as the existing bulkheads.
 - 49.1.4 No bailers shall be used except drain plugs or automatic drains installed in the transom. Electric Bilge pumps may be used along with automatic drains installed in the transom.
 - 49.1.5 Cavitation plates shall be optional and may be adjusted from inside of the rear cockpit by means of positive lock handle. No over-

ride assembly of any kind will be permitted.

- 49.1.6** The optional use of transmission, straight drive or Z drive is permitted, as long as the propeller shaft remains at a 1 to 1 ratio to the engine. The transmission must be forward, neutral, and reverse type and must be attached to the engine. No Vee or angle drives, steerable outdrives, steerable propellers or hydrofoils are permitted. A one way clutch is allowed. Propulsion shall be obtained only through the use of one (1) underwater screw-type propeller.
- 49.1.7** The propeller shaft strut must be rigidly mounted on the bottom of the boat, within thirty (30) inches (fore and aft) of the transom. This does not include whip struts. The propeller must be located under the bottom of the boat, excluding any cavitation plate area that extends beyond the transom. There shall be no form of lifting or planing devices for the boat to ride on, mounted on or built into the strut, rudder or any other underwater hardware.
- 49.1.8** The rudder shall extend a minimum of 13-3/4 inches below the bottom of the boat, measured off the true bottom (excluding any cavitation plate adjustments). The leading edge of the rudder must not be ahead of the trailing edges of the propeller.
- 49.1.9** No form of mechanical air foils or stabilizers, adjustable or non-adjustable, are to be used anywhere on the boat, other than vents.
- 49.1.10** Both the driver and rider will have the ability to shut off the motor while harnessed in their seats.
- 49.1.11** The prefix letters "JS" and racing numbers shall be of equal size. They will be in a contrasting color on both sides of the hull.
- 49.1.12** Any log type, cast aluminum, water cooled exhaust manifolds must be used and all gases and engine water must be mixed no farther than eight (8") inches from the exhaust manifold outlet and passed through the transom. The definition of a "Log Manifold" shall be: A cast aluminum common chamber connected to the cylinder head ports by runners no longer than 4". The runners must end at the common chamber. The outlet of the manifold is at the back of the manifold (towards the back of the boat). The manifold is water cooled with cast aluminum water jackets. **Alternatively, an OEM/ production available cast iron center riser manifold with the OEM cast iron riser may also be used.**
- 49.2** The only engines permitted shall be one (1) 283 C.I.D. or one (1) 305 C.I.D. Chevrolet automotive or marine engine.
- 49.3 283 CID** - All parts inside the engine must remain completely stock as furnished by the original engine manufacturer, except:
- 49.3.1 Block** - The engine block shall be a cast iron 283 Chevrolet V-8 with a maximum over bore of .070 inches (3.945). The stroke shall remain 3.000 inches and the minimum deck height shall be .038 inches measured with the compressed head gasket. The block may be align bored, decked, bored, horned, squared and deburred at the engine builder's discretion. The flywheel must be an automatic or standard transmission type or optional use of an aluminum flywheel. Any type or style of valve covers, timing chain cover or motor mounts/supports may be used. The use of sleeves for the purpose of making repairs only, shall be limited to (3) cylinders. Crankcase breathers may vent the engine in any manner. Valley trays under the intake manifold are permitted.
- 49.3.2 Oil Pan** - Any oil pan, mechanical oil pump driven off the distributor and pick-up may be modified in any manner provided the engine remains a wet sump system and that all oil lines and hoses remain inside the pan. The oil pan shall mean from the mounting surface of the block for the pan, down. There must not be any modifications to the main bearing caps for attaching of windage trays, etc. other than extended studs.
- 49.3.3 Crankshaft** - The crankshaft shall be a stock 283 C.I.D. cast iron or forged steel Chevrolet part with no knife edging, grooving, cross drilling, or enlargement of oil passages permitted. Chamfering of oil holes is permitted. Crankshafts may be chromed, reconditioned and balanced provided no alterations are made to the standard stroke.
- 49.3.4 Pistons and Rods** - Pistons can be any manufacturers cast or forged replacement that must meet the following specifications. The piston must have flat tops, four (4) or two (2) valve recesses and must meet stock dimensions. Wrist pins must meet stock dimensions and weights. No pistons are to be machined in any way other than for clearancing of wrist pins or balancing (wrist pin bosses or back side of piston tops). Tops of pistons may be machined (top of piston to top of first ring, not to be less than 245 thousandths). Any brand of full complement of rings must be used provided no alteration is done to the ring grooves in pistons (piston ring thickness must meet the stock specs of 5/64, 5/64, 3/16ths). Pistons may be rotated 180 degrees in the cylinder. Rods must be stock forged steel (5.7 inches in length). Flashing removal, shot-peening and polishing of rods is permitted. Any stock replacement rod bolt and nut that fits without machining or drilling may be used. Any replacement bearings, rod and main may be used. In addition to the above, the following press fit rods may be used, Manley Rod #14109A-8, Scat Pro Stock Rod #2-ICR5700-2000P, Eagle SIR # SIR5700SPLW along with floating rods Manley Rod #14105, Scat Pro Stock Rod #2-ICR5700-2000, Eagle SIR # SIR5700SBLW may also be used. No changes or alterations can be made to the Manley, Scat or Eagle rods. This includes balancing.
- 49.3.5 Camshaft** - Any aftermarket cam can be used providing it meets OEM profile under lifters are permitted. Only stock or roller type timing chain and gears are permitted. It shall be permissible to advance or retard the camshaft from its stock position. No matching other than the indexing of the camshaft alignment pin and for the mounting bolts is permitted on the timing gears.
- 49.3.6 Cylinder heads:** Must be stock for the 283 engine and shall bear casting mark  on the outside ends of the head. The minimum combustion chamber volume shall be 60cc. The intake and exhaust passages, as well as the combustion chambers, shall not be ground, polished or enlarged. Replacement of valve seats and guides shall be for reconditioning only. Cylinder heads may be ma-chined for valve seals, screw-in or pinned rocker arm studs, marine conversions and on contacting surfaces for the attachment to the block. No change is permitted in the valve area and angle of valve seat. Three angle valve seats are permitted in the head as follows: 1 approach; 1 seat; 1 bottoming. No angle is to be wider than .125 inch. Head gaskets are mandatory.
- 49.3.6.1 Valves:** Valves must be stock Chevrolet, GM, or any stock replacement valve (stainless permitted). Swirl polished valves are not permitted. The intake valve diameter shall be 1.720 inches and exhaust 1.50 inches. Valves will remain stock in shape and size.
- 49.3.6.2 Valve Springs:** Shims and any Stock or Stock replacement valve spring (no beehive spring allowed), single winding and dampener is permitted, provided no change or machining is required to the heads for their use.
- 49.3.6.3 Valvetrain:** Rocker arm ratio is to remain (1.5:1). Pushrods, retainers, and keepers must be stock Chevrolet or replacement parts sold over the counter for the non-racing automotive trade. Rocker arms and rocker balls may either be stock Chevrolet or replacement parts sold over the counter, or roller rockers may be used provided they maintain the stock rocker ratio (1.5:1) and stud mounting configuration (3/8" or 7/16"). The use of shaft roller rockers is prohibited. The use of polylocks and guide plates are permitted.

Jersey speed skiff Hull dimensions

Fig. 1 •

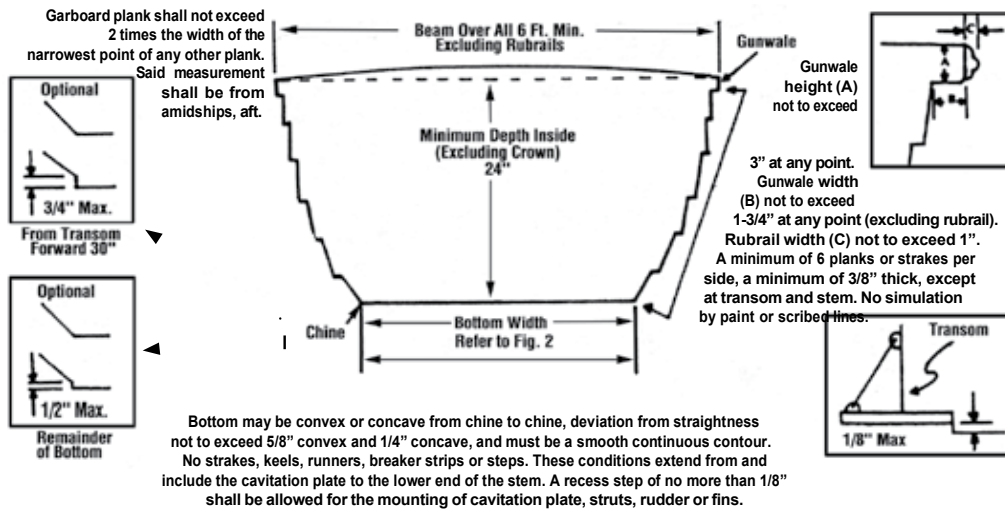
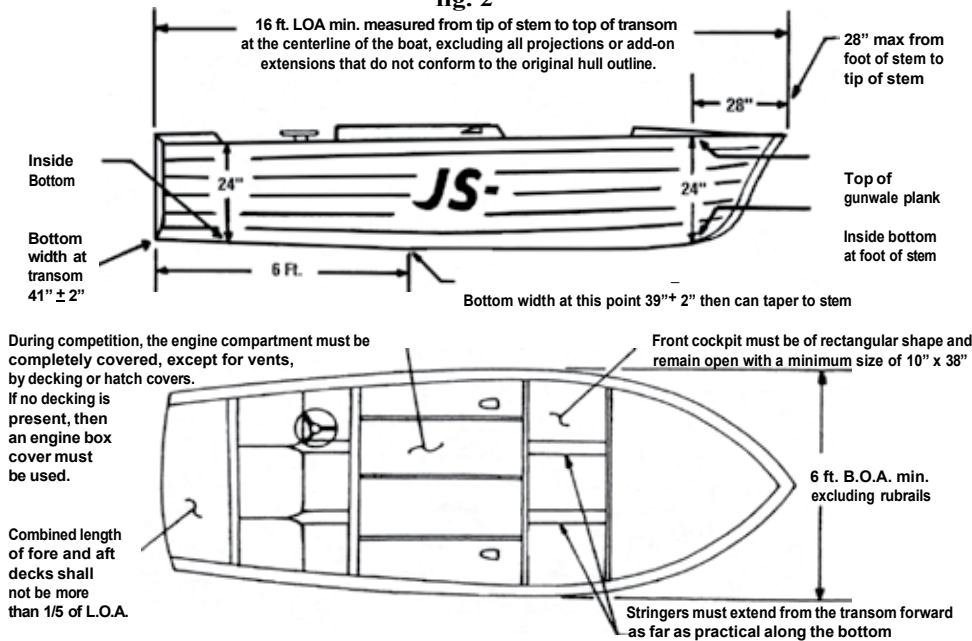

fig. 2



49.3.7 Intake Manifold - Intake manifold must be aluminum Edelbrock Torker II part #P/N5001 (for small block Chevrolet). The dimensions of the runners shall be 1.100 by 1.75 inches maximum at the cylinder head gasket face and .925 inches by 2.500 inches maximum adjacent to the plenum area. Note: Due to casting inconsistencies by the manufacturer, the following exception is allowed: A maximum of three (3) ports will be allowed to have a minority portion of each port exceed the stated measurements. No grinding, polishing, or enlargement of the inlet or outlet ports or runner area is permitted. Milling or changes to the shape for the attachment of the carburetor or adapter/wedge is not allowed. Blocking off the heat and water passages is permitted in the intake manifold or gaskets only. Machining for a steam vent in the intake manifold's normally casted closed rear water plate that leads directly to the head shall be permissible. A carburetor wedge or adapter to compensate for the engine angle may be used only if the total overall height does not exceed three (3) inches. This includes any gaskets or throttle linkage plates mounted between the intake manifold and the carburetor. The intake manifold must not be painted, dyed, anodized or in any other way finished.

49.3.8 Carburetor - The carburetor shall be limited to one (1) mass production American make, having not more than four (4) venturis. The throttle plate shall have holes no larger than 1.750 inches diameter. Any type air scoop or velocity stack may be used provided the air intake opening does not face forward if they protrude above the deck line. This condition pertains to whether the device is attached to the carburetor or engine hatch cover. No forward facing air deflectors allowed for air intake if they protrude above the deck line. Any fuel filter and mechanical or electrical fuel pump, with or without regulator may be used. Fuel. See **General Technical 40.18.12**.

49.3.9 Distributor - Any electric or single fire distributor that fits the 283/305 C.I.D. Chevrolet engine without adaptation is permitted. Magneto or crank triggered ignition, multi-spark discharge ignitions or remote controlled ignitions systems from inside the cockpit are prohibited. Tach drive distributors are permitted. Removal of the vacuum advance, altering the mechanical advance curve and fastening of the breaker plate, shall be allowed. Spark plugs, plug wires, distributor cap and ignition coil must be any OEM or stock replacement parts on the open market. Any single fire discharge ignition may be used as an alternate ignition.

49.3.10 Cool cans or devices to cool fuel are strictly prohibited.

49.3.11 Inspections - In the event that a new record is established, the engine must be dismantled to determine stock status and 6 point minimum inspection for the hull. At any race other than the Nationals and/or divisionals, the race committee can have any boat or any number of boats inspected and may use the 7 point inspection procedure for the engine and the 6 point inspection procedure for the hull. Not to preclude a more detailed inspection for both.

49.3.12 Jersey Speed Skiff Inspection Procedure, 283 cu. in. Chevy engine: This procedure will speed up inspections at the race site. Equipment needed for Inspectors: One 6" or 8" degree wheel attached to a distributor rotor.

One dial indicator with 0.500" travel.

One 4"x4"x3/16" steel plate with hole to attach to head bolt. One piece of wire for pointer.

49.3.13 Procedure to be used for Jersey Speed Skiff Camshaft:

Rotate engine in normal direction until the lifter is on the heel of the camshaft lobe. Set dial indicator on valve spring retainer. Preload dial indicator and set dial indicator back to zero. Adjust valve lash until dial indicator reads 0.001. Set dial back to zero. Rotate engine in normal direction until dial indicator reads 0.050 on the opening ramp. Set pointer to zero on degree wheel and start procedure as listed.

Camshaft: GM part #3736097 or #3736098

<i>Exhaust Lobe</i>		<i>Intake Lobe</i>	
<i>Lift</i>	<i>Degrees</i>	<i>Lift</i>	<i>Degrees</i>
.050	0	.050	0
.100	8	.100	7
.200	19	.200	18
.300	32	.300	31
.400	62	.394	61
.300	92	.300	88
.200	105	.200	101 Maximum lift of exhaust valve must not exceed 0.400 with zero lash.
.100	116	.100	112 Maximum lift of intake valve must not exceed 0.396 with zero lash
.050	122	.050	118

49.3.14 7 Point recommended minimum Inspection Procedure for 283 cu. in. engine (not to preclude single item inspection or more detailed inspection).

- Carburetor throttle plate max size 1.750
- Distributor, See Rule 2(j) or 3(j)
- Intake manifold and cylinder heads must not be polished or ground.
- Cylinder head volume 60cc min. and deck height .038 measured with compressed head gaskets.
- Valve sizes: - Intake 1.720 - exhaust 1.50
- Bore 3.945 max. - Stroke 3.00
- Profile camshaft

49.4 The 305 C.I.D. Chevrolet engine may be run as an alternate engine along with the 283 C.I.D. engine. All parts inside the engine must remain stock as furnished by the original engine manufacturer, except:

49.4.1 The block shall be a cast iron 305 Chevrolet V-8 with a minimum overbore of 3.771 inches. The stroke shall be 3.48 inches and the minimum deck height shall be .038 (thirty eight thousandths) measured with a compressed gasket from the top surface of the gasket to the top of the pistons. The block may be align bored, decked, bored, honed, squared and deburred at the engine builder's discretion. The flywheel must be an automatic or standard transmission type or optional use of an aluminum flywheel. Any type or style of valve covers, timing, chain cover or motor mounts/supports may be used. The use of sleeves for the purpose of making repairs only, shall be limited to (3) cylinders. Crankcase breathers may vent the engine in any manner. Valley Trays under the intake manifold are permitted.

49.4.2 Oil Pan - Any oil pan, mechanical oil pump driven off the distributor and pick-up may be modified in any manner provided the engine remains a wet sump system and that all oil lines and hoses remain inside the pan. The oil pan shall mean from the mounting surface of

the block for the pan, down. There must not be any modifications to the main bearing caps for attaching of windage trays, etc. other than extended studs.

- 49.4.3 Crankshaft** - the crankshaft shall be a cast iron or forged steel GM part with no knife edging, grooving, cross drilling, or enlargement of oil passages permitted. Chamfering of oil holes is permitted. Crankshafts may be chromed, reconditioned and balanced provided no alterations are made to the standard stroke (3.48 inches).
- 49.4.4 Pistons and Rods** - Pistons can be any manufacturers cast or forged replacement that must meet the following specifications. The piston must have flat tops, four (4) or two (2) valve recesses and must meet stock dimensions. Wrist pins must meet stock dimensions and weights. No pistons are to be machined in any way other than for clearancing of wrist pins or balancing (wrist pin bosses or back side of piston tops). Tops of pistons may be machined (top of piston to top of first ring, not to be less than 245 thousandths). Any brand of full complement of rings must be used provided no alteration is done to the ring grooves in pistons (piston ring thickness must meet the stock specs of 5/64, 5/64, 3/16ths). Pistons may be rotated 180 degrees in the cylinder.
- Rods must be stock forged steel (5.7 inches in length). Flashing removal, shot-peening and polishing of rods is permitted. Any stock replacement rod bolt and nut that fits without machining or drilling may be used. Any replacement bearings, rod and main may be used. In addition to the above, the following press fit rods may be used Manley Rod #14112A-8, Scat Pro Stock Rod # 2-ICR5700P, Eagle SIR # SIR5700BPLW along with floating rods Manley # 14101, Scat Pro Stock Rod #2-ICR5700, Eagle SIR # SIR5700BBLW may also be used. No changes or alterations can be made to the Manley, Scat or Eagle rods. This includes balancing.
- 49.4.5 Camshaft** - Any aftermarket cam can be used providing it meets OEM profile under these class rules. Stock or stock replacement solid valve lifters are permitted. Only stock or roller type timing chain and gears are permitted. It shall be permissible to advance or retard the camshaft from its stock position. No machining other than the indexing of the camshaft alignment pin and for the mounting bolts is permitted on the timing gears.
- 49.4.6 Cylinder heads:** Must be stock for the 305 Chevy engine and shall bear cast mark  on the outside ends of the head. The minimum combustion chamber volume shall be 60cc. The intake and exhaust passages, as well as the combustion chambers, shall not be ground, polished or enlarged. Replacement of valve seats and guides shall be for reconditioning only. Cylinder heads may be machined for valve seals, screw-in or pinned rocker arm studs, marine conversions and on contacting surfaces for the attachment to the block. No change is permitted in the valve area and angle of valve seat. Three angle valve seats are permitted in the head as follows: 1 approach; 1 seat; 1 bottoming. No angle is to be wider than .125 inch. Head gaskets are mandatory.
- 49.4.6.1 Valves:** Valves must be stock Chevrolet, GM, or any stock replacement valve (stainless permitted). Swirl polished valves are not permitted. The intake valve diameter shall be 1.720 inches and exhaust 1.50 inches. Valves will remain stock in shape and size.
- 49.4.6.2 Valve Springs:** Shims and any Stock or Stock replacement valve spring (no beehive spring allowed), single winding and dampener is permitted, provided no change or machining is required to the heads for their use.
- 49.4.6.3 Valvetrain:** Rocker arm ratio is to remain (1.5:1). Pushrods, retainers, and keepers must be stock Chevrolet or replacement parts sold over the counter for the non-racing automotive trade. Rocker arms and rocker balls may either be stock Chevrolet or replacement parts sold over the counter, or roller rockers may be used provided they maintain the stock rocker ratio (1.5:1) and stud mounting configuration (3/8" or 7/16"). The use of shaft roller rockers is prohibited. The use of polylocks and guide plates are permitted.
- 49.4.7 Intake Manifold** - Intake manifold must be aluminum Edelbrock Torker II part #P/N5001 (for small block Chevrolet). The dimensions of the runners shall be 1.100 by 1.75 inches maximum at the cylinder head gasket face and .925 inches by 2.500 inches maximum adjacent to the plenum area. Note: Due to casting inconsistencies by the manufacturer, the following exception is allowed: A maximum of three (3) ports will be allowed to have a minority portion of each port exceed the stated measurements. No grinding, polishing, or enlargement of the inlet or outlet ports or runner area is permitted. Milling or changes to the shape for the attachment of the carburetor or adapter/wedge is not allowed. Blocking off the heat and water passages is permitted in the intake manifold or gaskets only. Machining for a steam vent in the intake manifold's normally casted closed rear water plate that leads directly to the head shall be permissible. A carburetor wedge or adapter to compensate for the engine angle may be used only if the total overall height does not exceed three (3) inches. This includes any gaskets or throttle linkage plates mounted between the intake manifold and the carburetor. The intake manifold must not be painted, dyed, anodized or in any other way finished.
- 49.4.8 Carburetor** - The carburetor shall be limited to one (1) mass production American make, having not more than four (4) venturis. The throttle plate shall have holes no larger than 1.750 inches diameter. Any type air scoop or velocity stack may be used provided the air intake opening does not face forward if they protrude above the deck line. This condition pertains to whether the device is attached to the carburetor or engine hatch cover. No forward facing air deflectors allowed for air intake if they protrude above the deck line. Any fuel filter and mechanical or electrical fuel pump, with or without regulator may be used. **Fuel. See General Technical 40.18.12**
- 49.4.9 Distributor** - Any electronic or single fire distributor that fits the 283/305 C.D.I. Chevrolet engine without adaptation is permitted. Magneto or crank triggered ignition, multi-spark discharge ignitions or remote controlled ignition systems from inside the cockpit are prohibited. Tach drive distributors are permitted. Removal of the vacuum advance, altering the mechanical advance curve and fastening of the breaker plate, shall be allowed. Spark plugs, plug wires, distributor cap and ignition coil must be any OEM or stock replacement parts on the open market. Any single fire discharge ignition may be used as an alternate ignition.
- 49.4.10 Carburetor wedges, cool cans or devices to cool fuel** are strictly prohibited.
- 49.4.11 Inspections** - In the event that a new record is established, the engine must be dismantled to determine stock status and a 6-point minimum inspection done on the hull. At any race other than the National and/or divisionals, the race committee can have any boat or any number of boats inspected using the 7-point inspection procedure for the engine and the 6-point inspection procedure for the hull (not to preclude a more detailed inspection for both).
- 49.4.12 305 Cu. In. Chevy Engine Camshaft Profile**
Tools required: One 6" or 8" degree wheel attached to rotor button in a point distributor; one 500 thousandth travel dial indicator and a wire pointer.
- 49.4.13 Procedure:** Rotate engine in normal direction until the lifter is on the heel of the camshaft lobe. Set dial indicator on valve spring retainer. Adjust valve lash until dial indicator reads .001. Set dial indicator back to zero. Rotate engine in normal direction until dial indicator reads .050 stop. Set degree wheel to zero degrees. Rotate engine in normal direction and check every .050 thousandths lift.

Read degrees on degree wheel. Camshaft: Crane part #11F000141

Exhaust Lobe		Intake Lobe		
Lift	Degrees	Lift	Degrees	
.050	0	.050	0	
.100	6	.100	6	
.200	18	.200	19	
.300	33	.300	34	
.400	60	.394	63	
.300	88	.300	90	
.200	102	.200	105	Maximum lift at valve -
.100	115	.100	118	Exhaust 400- Intake 394
.050	123	.050	126	Lobe spacing - 110 degrees

To check lobe spacing open exhaust valve to .250 thousandth lift. Set degree wheel to zero. Open intake valve to .250 thousandths lift. The degree wheel should read 116 degrees or 232 crankshaft degrees.

49.4.14 7 Point recommended minimum Inspection Procedure for 305 Cubic Inch Motor (Not to preclude single item/more detailed inspection)

Carburetor throttle plate size 1.750 max.

Distributor must be single point.

Intake manifold and cylinder heads must not be polished or ground.

Cylinder head volume 60cc min. and deck height .038 measured with compressed head gaskets. Valve sizes: intake 1.720 / exhaust 1.50

Bore: 3.771 max. Stroke 3.48 Profile camshaft

49.4.15 6 Point recommended minimum Inspection for Boat (Not to preclude single item / more detailed inspection) Length - 16' minimum

Width - 6' minimum

Rudder length - 13-3/4" minimum

Depth inside hull - 24" minimum

Bottom profile - 1/4" concave 5/8" convex Weight - 1600 pounds

RULE 50 – INBOARD RUNABOUT CLASSES

The **Technical Manual for Inspection and Measurement of the Racing Runabout** is in the Appendix of these rules, and on www.apba.org under Resources/RULEBOOKS.

- 50.1 Hulls:** Inboard racing Runabout hulls shall be a displacement or monoplane type; and shall be equipped with forward and aft decks. The combined total length of the two decks shall not be less than 1/5th of L.O.A.
- 50.2 Longitudinal and Transverse Breaks:** Hulls shall have no step and there shall be no breaks in the longitudinal or transverse continuity of the immersed surfaces other than the keel, rubbing strips, and strakes (breaker strips).
- 50.2.1** These shall be of no greater depth than 5/8ths inch, and run in a fore and aft direction.
- 50.2.2** All longitudinal breaks shall be essentially parallel to the keel, from the trailing edges to amidships.
- 50.2.3** Strakes terminating forward of the trailing edges must do so at no more than a 45 degree angle to the adjacent bottom surface.
- 50.2.4** The keel shall not be higher than a straight line from chine to chine, or to any spray rails attached to chines, from the trailing edges to amidships.
- 50.2.5** Strake depth shall not interfere with a straightedge touching keel and chine, in the area from the trailing edges of planking surfaces, to fifty-four inches forward of the trailing edges. This shall be from the major trailing edges including cavitation plate(s) excluding projections, from cavitation plate.
- 50.2.6** There shall be no limitations to the number or width of strakes used, and they may extend to include cavitation plate.
- 50.2.7** There shall be allowed a 1/8" break or step in the transverse direction for the purpose of attaching hardware such as fins, water pickups, turning fins, strut, etc. to the bottom of hull.
- 50.3 Flat Keels:** Hulls may have a flat keel area on both sides of centerline. The outer edges of the flat keel area shall be essentially parallel to the centerline of the hull, in the area from the transom to fifty-four (54) inches forward of the transom.
- 50.3.1** In this flat keel area concavity (hollow) shall not exceed 1/8th inch per foot, as measured from a straight edge, running parallel to the transom, in the area from the trailing edges of planing surfaces, to fifty-four inches forward of the trailing edges. This shall be from the major trailing edges including cavitation plate(s) excluding projection from cavitation plate.
- 50.4 Concavity:** Hulls shall have no more than 5/8th inch concavity (hollow) from keel to chine, from trailing edges to amidships.
- 50.4.1** Measurements shall be taken from a straightedge placed from keel to right and left chines, or the lower edge of any spray rails attached to chines.
- 50.4.2** Any portion of the bottom width that exceeds 5/8" concavity (hollow) shall be declared illegal.
- 50.5 Cavitation Plates:** Hulls may be equipped with cavitation plates. Plates may be adjusted while boat is in motion. Cavitation plates shall conform with all measurements required of hull at a given handle or foot control setting. At the point at which the cavitation plate(s) attach to the hull, there shall be a maximum recess of 1/8th inch allowed between the bottom surface of the plates and the bottom of the hull.
- 50.6 For purposes of definition** and measurement of the above rules, strakes, breaker strips, spray rails, and rubbing strips are considered the same. The keel is the fore and aft centerline of the hull bottom.
- 50.6.1** The term "trailing edges" shall include cavitation plate(s).
- 50.6.2** Surfaces required to be parallel to centerline shall not vary more than one inch per foot. It shall be allowable to add aluminum, wood or fiberglass to a hull to bring hull into rule requirements.
- 50.6.3** Fins, Struts, and Blast Plates, located between the strut and leading edge of the cavitation plates, shall not be included in any measure-

ment. The use of any side mounted fin is not allowed. Any small fins located on the cavitation plates will be acceptable. An offset outboard style rudder is acceptable.

50.6.4 There is no tolerance allowed for warpage, settling, etc.

50.7 When any engine or hull is the subject of protest or questioned as to compliance with these rules, the Inboard Racing Commission of the APBA may order a special inspection, or at its discretion require the owner to file such drawings as are necessary to show the protested or questioned condition. The report of the Inspector or the drawings shall be submitted to the proper Runabout Technical Committee for analysis and opinion. If the hull is deemed to violate the provisions of the rules in letter or spirit, or if the owner should not provide the required information, the boat may be barred from racing.

50.8 Hull Lifting Requirements: For the purpose of inspection, it shall be the owner's responsibility to have some device, sling, or point in your hull to which the hook of a crane, backhoe, boat launch tram hook, tow truck hook, etc., can be attached, to safely lift your hull off the trailer for inspection. The inspector shall determine if this device, sling, or point, is capable of safely lifting the hull. Your boat can be declared illegal if you cannot meet this requirement for inspection.

CLASS RACING INFORMATION

Class	Letter	Min Age	Max per Heat	Min Length	Max Length	Min Width	Weight with driver lbs.	4 leg sling min wt. per leg LBS	3 leg sling 1.5x min wt. per leg lbs.	2 leg sling 2x min wt. per leg lbs.	1 sling 2.5 min wt. per leg lbs.
Sportsman Entry	SE	16	10	16'		6'	1850	1850 (7400)	2775 (8325)	3700 (7400)	4625
Sportsman Advanced	SA	18	10	16'	20'	6'	1850	1850 (7400)	2775 (8325)	3700 (8325)	4625
Pro Stock	PS	21	10	16'	20' 21'	6'	1950 2200	1950 (7500)	2925 (8775)	3900 (7800)	4875
KRR	K	21	8	16'	20' 21'	6'	2250 2400	2250 (9000)	3375 (10125)	4500 (9000)	5625
Crackerbox	P	Driver 18 Rider 16	8	13'6"	15'10" 13'16"		1250 w/o driver/rider	1250 (5000)	1875 (5625)	2500 (5000)	3125
Grand National	GN	18									
Comp Jet	CJ	16			24						
Classic Endurance		16			23						

RULE 51 - CRACKERBOX CLASS

51.1 Crackerbox Class boats must conform to the APBA rules for Inboard racing, the rules for Inboard Runabout Classes and measure in accordance with the specifications and limitations set out in the rules listed below. The official *Technical Inspection Manual and Guide to Measuring the Racing Crackerbox, Appendix B*, shall be used as a guide for hull inspection.

51.2 Boats to be raced with two persons on board — no exceptions.

51.3 Fuel shall be gasoline of a type available for automotive, marine and aviation use. For the 275 cubic inch displacement engine only, methanol fuel may be used.

51.4 Engine: Competing boats shall be powered by one internal combustion four-cycle engine. Carburetors or mechanical fuel injection shall be permitted where specified. An aftermarket starter may be used. Ignition may be battery or magneto. The block, OEM or aftermarket permitted, must be cast iron and based on a U.S. automotive production design. The cylinder heads must be of OEM design, but aftermarket parts may be used including aluminum heads. There shall be no more than two valves per cylinder. There shall be no superchargers or overhead cam.

51.4.1 275 CID Option: The total maximum displacement of engines used shall not exceed 275 cu. in.

51.4.2 314 CID Option: The total maximum displacement of engines used shall not exceed 314 cu. in. Shall be limited to one 650 CFM Holley carburetor Model #4150, Part #4777C (classic series), and all dash numbers, and is to remain "as furnished" by the manufacturer. Any modification not written herein will not be permissible or allowed. The following dimensions not to exceed: Throttle bore of 1-11/16", Primary venturi of 1-1/4" and secondary venturi of 1-5/16". Booster venturi shall not be modified from original and must be mounted in the original location. A carburetor test gauge kit, 7864 for Holley 0-4777 series 650 CFM Carburetors is available from BLP Products, 1015 West Church St., Orlando, FL 32805; phone 800-624-1358. It will be permissible to use epoxy to keep the booster venturi in place. Metering blocks are to remain unchanged from original. Milling of choke horn is not allowed. The choke assembly may be removed as well as any linkages that are not used. Power valve may be blocked. Accelerator pump nozzles and inlet jets may

be changed. Accelerator pump must remain stock at 30cc. Any float may be used that fits in the float bowl. Any device to prevent fuel

sloshing may be used. Jet extenders are permitted. All other existing motor rules apply.

51.5 Hulls

51.5.1 Wood: Boats must be planked with minimum 1/4" thick plywood.

51.5.2 All offsets are measured to outside of planking. (*See illustration*)

51.5.3 All dimensions in the table of offsets have a tolerance of one inch + or - except as noted below. PLEASE SEE CHART.

Overall width	Minimum	Maximum
At transom -	55-1/2"	60-7/8"
At station 7 -	64-1/8"	70"
At station 4 -	56"	64"
Length	13' 6"	15' 6"

Measurement from base line to keel at stations 8 and 9 must be 1/16"

TABLE OF OFFSETS — measurements are in inches and sixteenths of inches

STATION	13	12	11	10	9	8	7	6	5	4	3	2	1	0
BASE TO KEEL	0-10	0-6	0-4	0-2	0-1	0-1	0-4	0-8	1-0	0-15	3-12	6-12	11-0	22-10
BASE TO CHINE	1-1	1-0	0-15	1-0	1-4	1-11	2-6	3-6	4-12	6-10	9-0	12-1	15-15	22-10
BASE TO SHEER	15-0	16-11	18-7	19-12	20-12	21-8	22-0	22-6	22-10	22-13	22-14	22-12	22-12	22-10
BASE TO DECK	18-2	19-11	21-1	22-12	23-11	24-5	24-10	24-13	24-13	24-12	24-6	23-15	23-8	22-10
CL TO CHINE	29-7	30-3	31-0	31-12	32-6	32-14	33-1	32-11	31-11	29-11	26-1	20-8	13-4	0-0
CL TO SHEER	27-7	28-11	30-1	31-3	32-3	32-14	33-5	33-7	33-0	31-8	28-10	23-9	16-0	0-0

51.5.4 Boats shall be not more than 15 feet 10 13/16 inches long or less than 13 feet 6 inches measured from bow to transom. Allowable deviations not to exceed one inch from frame No. 4 to No. 13 inclusive. On all measurements shown forward of frame No. 4, the bow may be altered to suit. All dimensions in the table of offsets have a tolerance of one inch (plus or minus); measurement from the base line to keel at station #8 and #9 must be 1/16th of an inch.

51.5.5 The cockpit shall be located in the space between 9-1/2 inches in front of the transom and station 9 and the engine shall be mounted ahead of station 9. A minimum of 9-1/2 inches must exist between transom and seat back for both driver and rider seats and these seats must be bolted in place. Minimum distance from transom to tip of crankshaft is 53 inches.

51.5.6 For purposes of definition: The keel is the fore and aft centerline of the hull bottom.

51.5.7 The bottom shall not have longitudinal or transversal steps outside the keel centerline including relieved chine or concavity. The bottom of the hull from keel to chine shall be flat, however, to accommodate settling. It may have some concavity, which will include any deviation from a theoretical straight line from keel centerline to chine. There will be a 1/8 inch maximum deviation in the concavity measurement from the transom to 54 inches and a 1/4 inch maximum deviation from 54 inches forward. When the above hardware prevents placing a straightedge directly on the keel centerline, the Inspector shall place the straight-edge as close to the keel centerline as possible. Reference the *Technical Inspection Manual and Guide to Measuring the Racing Crackerbox* for measuring procedure. The wood hull is to be constructed using wood frames covered with plywood not less than 1/4 inch thick. The fiberglass hull must be built in within the same specifications and limitations as wooden hull construction; however, wood frames will not be required. All frames and station numbers will be converted into inches to determine the same location of cockpit and engine as in the present design.

51.5.8 Hull bottoms shall have no breaks in the longitudinal or transverse continuity other than the keel. There shall be allowed a 1/8" break or step in the transverse direction for the purpose of attaching hardware such as fins, water pickups, turning fins, strut, etc. to the bottom of hull.

51.5.9 All longitudinal breaks shall be essentially parallel to the keel, from the transom to amidships.

51.5.10 The keel shall not be higher than a straight line from chine to chine from the transom to amidships.

51.5.11 Hulls may have a flat keel area on both sides of centerline. The outer edges of the flat keel area shall be essentially parallel to the centerline of the hull, in the area from the transom to fifty-four (54) inches forward of the transom.

51.5.12 In this flat keel area concavity (hollow) shall not exceed 1/8th inch per foot, as measured from a straight edge, running parallel to the transom, in the area from the transom to fifty-four inches forward of the transom.

51.6 Hardware

51.6.1 Vee drives or gear boxes shall not be permitted.

51.6.2 Shaft angle and propeller location is optional but engine must be mounted forward of cockpit.

51.6.3 Couplers between in and out boxes and propeller shaft for Cracker Box boats shall be a minimum of 3.5 inches long and utilize a minimum of 4 clamping bolts. Set screws shall be used in each end of the coupler. Each shaft shall be dimpled to receive set screws. A safety collar on the propeller shaft, within 0.5 inches of the leading end of the strut or a safety collar within 0.5 inches of the shaft log assembly is mandatory. Safety collars must be configured so they will prevent the shaft and propeller from sliding back and hitting the rudder. Safety collars in all classes shall be machined from bar stock, not pressed metal (sintered iron).

51.6.4 Rudder assembly, prop shaft size may be optional.

51.6.5 Adjustable plates mounted at the rear of the hulls will be allowed provided they are not adjustable while the boat is in motion and provided they do not intercept the bottom of the hull longitudinally or transversely by any form of break or step. In no case can this plate be considered in measuring length of boat.

51.7 Safety Equipment

51.7.1 Besides following all the APBA General Safety Rules for helmets and life jackets, it will be required for all open Crackerbox Boat drivers/riders to Adhere to RULE 3.5.3 Drivers/Riders not in restraint capsules shall wear straps (lanyards) secured to the driver's/ rider's body as required or a head and neck Restraint device. APBA will make no recommendation on which device to use. This is solely on the driver/ rider.

RULE 52 - K RACING RUNABOUT CLASS

The objectives of the rules for K Racing Runabout Class are to govern and promote a Professional class of propeller driven Inboard Racing Runabouts using unlimited and/or unrestricted engines and fuels.

52.1 Drivers must be at least 21 years of age and qualified in PS to be eligible to drive in KRR.

-OR-

A driver who is either qualified in a lower class than PS or has been inactive for 24 calendar months is deemed a "Qualifying Driver." To be eligible to compete in a heat race, the driver must:

a. Run a minimum of 5 laps or more, accumulated at testing or Time Trials (at a race or APBA approved testing opportunity), two-thirds (2/3) of which must be at or above class-appropriate competitive speeds prior to competing in a heat race.

b. Get signatures from two (2) qualified drivers and at least one (1) referee or two (2) referees they have raced under.

52.1.2 Any driver new to the K Racing Runabout class must complete a minimum of four (4) heats, starting at the rear of the pack and advancing only to a position predetermined by the referee.

52.2 Minimum hull length shall be 17 ft. L.O.A. and the Maximum hull length shall be 20 feet L.O.A. not including cavitation plates.

-OR-

52.2.1 When using the optional 21 foot rule, the following rule must be met:

52.2.1.1 Maximum length 21 feet excluding the cavitation plate. Minimum length 19 feet excluding the cavitation plate 51.4.1.2 Strake depth must not exceed one and one quarter inch from trailing edge to mid ship.

52.2.1.2 Bottom concavity must not exceed one and one quarter inch from trailing edge to mid ship.

52.2.1.3 Nothing must interfere with a straight edge from keel to chine in the area from trailing edge to 65 inches forward. 51.4.1.5 Dead rise at the transom must not exceed 4 degrees.

52.2.1.4 All boats meeting this optional 21-foot rule must weigh a minimum of 2,400 pounds.

52.3 Hull must be a flatbottom boat design and conform to the GENERAL RULES FOR INBOARD RUNABOUTS, racing classification.

52.6 Stabilizers, wing sections or airfoils may be installed, provided they are used in a horizontal position no wider than the beam of the boat under the areas of stabilizer installation. They may not be adjusted while the boat is in motion, nor will they be installed to the rear (aft) of the transom. They shall not be positioned forward of amidships. The leading edges shall be no closer than 24 in. from the top of the inside back of the driver's seat. The leading-edge center line shall not be mounted more than 10 in. above the blower(s), injector(s) or top surfaces of other engine top mountings.

52.6.1 The general condition of the installation, fiberglass, fuel tank(s) or cell(s), underwater gear including rudder, rudder port, prop wash plate, strut, fins, cavitation plates, prop shaft, and propeller. If any component is found to be marginal, the inspector shall not allow said boat to participate in racing until the violation is repaired.

52.6.2 The drive line or shaft must be covered with either 1/8" steel or 1/4" of aluminum.

52.6.3 The engine must be supercharged or turbocharged. Any fuel, any modifications to the engine are allowed.

52.6.4 A cone shaped shaft collar must be affixed to the vessel, a maximum of 1/2" in front of the leading edge of the strut

tube.

52.7 Any boat that is involved in an accident must be inspected immediately afterward, if possible, by the Inspector. The inspector shall document all apparent damage and instruct the owner on the repairs required prior to competing again. Once the boat has been repaired the inspector shall re-inspect and determine if the boat is safe and legal.

52.8 All parts including engines and hulls in their entirety, may be changed at any time, as long as said hull belongs to the same owner prior to that race.

52.9 Prop releases are mandatory on all K-boats at all races.

52.10 ALL BOATS MUST HAVE REINFORCED COCKPITS AS PER RULE 3.1.1 AND 3.1.2 and meet helmet requirements per rule 3.5.3.

RULE 53 - PRO STOCK RUNABOUT CLASS

The objectives of the rules for Pro Stock Runabout Class are to govern and promote a Professional class of propeller driven Inboard Racing Runabouts using limited and/or restricted engines and fuels.

53.1 Minimum hull length shall be 16 ft. L.O.A. and the maximum shall be 20 ft. L.O.A. including cavitation plates. Minimum beam 72" wide.

-OR-

53.1.1 When using the optional 21 foot rule, the following rule must be met:

53.1.1.a. Maximum length 21 feet excluding the cavitation plate. Minimum length 19 feet excluding the cavitation plate 51.4.1.2 Strake depth must not exceed one and one quarter inch from trailing edge to mid ship.

53.1.1.b. Bottom concavity must not exceed one and one quarter inch from trailing edge to mid ship.

53.1.1.c. Nothing must interfere with a straight edge from keel to chine in the area from trailing edge

to 65 inches forward. 51.4.1.5 Dead rise at the transom must not exceed 4 degrees.

53.1.1.d. All boats meeting this optional 21-foot rule must weigh a minimum of 2,200 pounds.

- 53.1 Hull must be a flatbottom boat design and conform to the GENERAL RULES FOR INBOARD RUNABOUTS, racing classification.
- 53.2 A cone shaped shaft collar must be affixed to the vessel, a maximum of ½” in front of the leading edge of the strut tube.
- 53.3 Engine Specifications: Single American automotive block with a maximum cubic inch displacement - 510 C.I.D. No superchargers, turbochargers or blowers of any type. Fuels restricted to pump, aviation and methanol blends. All internal and external engine modifications accepted. All ignition systems accepted.
- 53.4 Engine must mount rear of amidship and drive forward through Vee drive.
- 53.5 A pre-race safety and technical inspection of all P/S boats may be performed by the Inboard Inspector prior to any testing, qualifying or heat racing. It is the responsibility of the Inboard Inspector, not the liability, to ensure that all boats entering the water are legal P/S boats. The inspection must include, but is not limited to, the following:
 - 53.5.1 The general condition of the installation, fiberglass, fuel tank(s) or cell(s), underwater gear including rudder, rudder port, prop wash plate, strut, fins, cavitation plates, prop shaft, and propeller. If any component is found to be marginal, the inspector shall not allow said boat to participate in racing until the violation is repaired.
 - 53.5.2 The drive line or shaft must be covered with a minimum of either 1/8” of steel or 1/4” of aluminum.
- 53.6 Any boat that is involved in an accident must be inspected immediately afterward, if possible, by the Inboard Inspector. The Inspector shall document all apparent damage and instruct the owner on the mandatory repairs needed prior to competing again. Once the boat has been repaired the Inspector shall re-inspect and determine if the boat is safe and legal.
- 53.7 In the interest of safety, it is mandatory that a prop shaft release (i.e., Whirlaway) is utilized when entering circle racing and kilo competition.
- 53.8 Drivers must be at least 21 years of age.
 - 53.8.1 Any driver new to the PS class must complete a minimum of ten (10) heats, starting at the rear of the pack and advancing only to a position predetermined by the referee.

ALL BOATS MUST HAVE REINFORCED COCKPITS AS PER RULE 3.1.1 AND 3.1.2 and meet helmet requirements per rule 3.5.3

RULE 54 - SPORTSMAN ENTRY (SE) CLASS

SE (Sportsman Entry) is an entry level class intended to promote a fun, affordable class with a maximum speed of 90.0 mph using only GM or Ford or aftermarket equivalent cast iron small block and cast iron heads derived from passenger or truck model vehicles sold in North America (on road vehicles only), and abiding by inboard runabout and safety rules including rule 3.5.3.

-OR-

Promotors option: 85 mph speed limit can be enforced when it is stated on the sanction.

54.1 General Rules

54.1.1 A prop shaft release is required.

54.1.1.1 A minimum of 7/8 -inch prop shaft is mandatory

54.1.1.2 A cone shaped shaft collar must be affixed to the vessel, a maximum of ½” in front of the leading edge of the strut tube.

54.1.2 Maximum speed of 90.0 mph without tolerances. A boat that exceeds the 90.0 MPH limit by up to 1 MPH (90.1-91.0 MPH) will receive a 1-minute penalty, a boat that exceeds 91.1 MPH will be disqualified for the heat

-OR-

Promotors option: Maximum 85mph speed limit can be enforced. This MUST be stated on the sanction. A speed of 86.00 mph to 87.99 mph will be considered a “break out” speed and the boat will be scored in last place position. A speed of 88.00 mph and higher will be a disqualification for that heat and no points will be awarded.

54.1.3 A GPS unit must be installed (in a location approved by the inspector) by the inspector or his/her delegate before each run on the water (testing or racing). It will be the owner’s responsibility to see that it happens. The GPS will be checked by the inspector of the event or his appointed representative. GPS readings will be included on the summary sheets. The inspector or his/her delegate will be the last person to touch the GPS before each heat and the first one to touch the unit when the boat returns to the dock. Failure to show speed, or to follow the rules will result in a disqualification.

54.1.3.1- It is the responsibility of the owner to have a working GPS onboard their vessel. This GPS must be a Garmin eTrex. Submit other model numbers to the IRC for approval.

54.1.3.2- All drivers must provide a working unit at each drivers meeting. Units must have the boat number on them. They will be placed into a bag and will be drawn at random for each driver. Drivers will receive their personal GPS units back at the end of the race weekend. GPS units will be redrawn throughout the weekend if it is deemed necessary.

54.1.4 Because this is a speed limited class, there shall be no competition or kilo records kept

54.1.5 Minimum length of an SE hull is 16 feet.

54.1.6 Minimum width of a SE hull is 72 inches.

54.1.7 Hulls under these minimums which competed in an older racing class are to be grandfathered. Contact the Inboard office for confirmation.

54.1.8 Minimum weight, including driver and safety equipment, shall be 1850 pounds weighed immediately after a heat of racing, after draining the hull of water.

54.2 Hull Configuration

54.2.1 The hull must conform to the flatbottom hull requirements as specified in the Technical Manual for the Inspection of Racing Runabouts. Non-current hulls which do not conform to these specifications may be exempted by petition to the Flatbottom Committee.

54.2.2 All fins shall be mounted between the chines on the underside of the hull.

54.3 Engine

54.3.1 General Notes

54.3.1.1 No titanium engine parts are allowed.

54.3.2 Block Assembly. Any GM cast iron small block or Ford cast iron Windsor small block engine block designed for general automotive, or truck use may be used. Aftermarket blocks may also be used.

54.3.3 **Bore and Stroke.** Maximum Bore x Stroke is 4.065” x 3.500”

54.3.4 **Crankshaft.** Any aftermarket crankshaft may be used.

54.3.5 Pistons.

54.3.5.1 Only flat top pistons with valve relief(s) are permitted.

54.3.5.2 Any aftermarket pistons may be used..

54.3.6 **Connecting Rods.** Any aftermarket steel connecting rods may be used.

54.3.7 Cylinder Heads.

54.3.7.1 Stock or aftermarket equivalent cast iron cylinder head with inline valves at no less than a 23-degree angle for Chevrolet or 20-degree angle for Ford (valve angles) may be used.

54.3.7.2 No porting, polishing, or grinding is permitted in ports or combustion chambers.

54.3.7.3 Heads shall have a maximum intake runner volume of 170 cc

54.3.7.4 A maximum compression ratio of 9.5:1 only.

54.3.8 Camshaft and Valve Train

54.3.8.1 Camshafts.

54.3.8.1.1 Only flat tappet camshaft and lifters may be used.

54.3.8.1.2 Either hydraulic or mechanical lifters with a maximum diameter of 0.843” for GM or 0.876” for Ford may be used.

54.3.8.1.3 Maximum lift, measured at the valve, shall not exceed 0.450” (lift is to be inspected @zero lash).

54.3.8.2 **Timing Chain.** Use of any chain set or gear drive of dual idler design only is permitted.

54.3.8.3 Valves.

- 54.3.8.3.1** All steel or stainless steel valves with a minimum valve stem diameter of $1\frac{1}{32}$ " with a minimum 0.340/0.341 stem diameter. Aftermarket performance valves and steel or aluminum retainers allowed.
 - 54.3.8.3.2** Maximum diameter of intake valve is 1.945" for GM .GM 305 heads and Ford heads 1.845".
 - 54.3.8.3.3** Maximum diameter of exhaust valve is 1.505" for GM and 1.545" for Ford.
- 54.3.8.4** Valve Springs. Valve springs shall have a maximum diameter of 1.260" for GM and 1.445" for Ford with an allowable tolerance of ± 0.040 ".

54.3.8.5 Rocker Arms.

- 54.3.8.5.1** Roller type rocker arms with a maximum ratio of 1.52 for GM or 1.60 for Ford may be used.(Lift at cam x 1.5 for GM or 1.60 for Fords helps determine legal rocker ratios) may be used.
- 54.3.8.5.2** Studs and/or guide plates with $\frac{5}{16}$ " pushrods may be used.

54.3.8.6 Adjusting Nut. Any adjusting nut, posi loc, strut girdle may be used. No shaft type rocker assy

54.3.9 Intake System

54.3.9.1 Intake Manifold.

54.3.9.1.1 Any production style as cast/as produced iron or aluminum intake manifold may be used

54.3.9.1.2 Sheetmetal or tunnel ram style intake manifolds are expressly prohibited.

54.3.9.2 Other Intake System

54.3.9.2.1 A carburetor spacer is required; it shall have a minimum thickness of 0.500" (including gaskets) and a maximum thickness of 2.25" (including gaskets. The spacer may be wedge shaped, if desired, providing it fits within the above envelope. A restrictor plate, if required, shall be in addition to this thickness.

54.3.9.2.2 The intake manifold may be matched or blended to the carburetor spacer.

54.3.9.2.3 Use of any intake scoop, velocity stack, and/or air cleaner is permitted.

54.3.10 Fuel System

54.3.10.1 Carburetor

54.3.10.1.1 Carburetor is to be a Holley manufactured # 4776 (all series). The center section/main body must remain stock and as furnished by Holley. The choke mechanism and related components may be removed. The air horn can be milled off. No HP center section/main body allowed. Only the following dimensions are to be inspected/measured: Primary/Secondary venturi @ 1.265/1.3275 maximum. Throttle plate bore @ 1.5675 maximum. All other modifications permitted.

54.3.10.1.2 Maximum venturi diameters: Primary/Secondary = 1.265"/1.3275"

54.3.10.1.3 Maximum throttle plate bore is 1.5675"

54.3.10.2 Fuel and Fuel System

54.3.10.2.1 Any pump gas may be used, including E85. See Rule 40.18.12

54.3.10.2.2 Any fuel pump is permitted

54.3.11 Ignition.

54.3.11.1 Ignition system may be either points-type system or HEI system

54.3.11.2 Electronic ignition systems are not permitted. Pertronix distributor points conversions may be used.

54.3.11.3 Any plug wires may be used.

54.3.11.4 Firing order is to be 18436572 for GM and 13726548 for Ford

54.3.12 Exhaust. Any log type manifold, individual pipes "zoomies" or standard 4 into 1 header may be used. The collector must be a standard straight style with no choke/merge type collectors allowed. Each pipe must have no more than one step/diameter change in its length, no multi step tubes allowed. Tri-Y and 180 type headers are prohibited.

54.3.13 Lubrication System.

54.3.13.1 A wet sump system with the oil pump mounted in the stock location is required.

54.3.13.2 Any oil pan is permitted

54.3.13.3 Accusump systems are permitted

54.3.14 Other Specifications

54.3.14.1 Any gasket set may be used.

54.3.14.2 Vacuum pumps are not allowed.

54.3.14.3 Use of a heavy duty/SFI flexplate or aluminum flywheel is recommended.

54.3.15 Safety Equipment

54.3.15.1 Besides following all the APBA General Safety Rules for helmets and life jackets, it will be required for all open SE Boat drivers to Adhere to RULE 3.5.3 Drivers/Riders not in restraint capsules shall wear straps (lanyards) secured to the driver's/rider's body as required or a head and neck Restraint device. APBA will make no recommendation on which device to use. This is solely on the driver/rider.

RULE 55 - SPORTSMAN ADVANCED (SA) CLASS

SA (Sportsman Advanced) Class is open to all hulls, capsule or non-capsule (open boats) that meet all the current APBA runabout hull rules (Appendix A) with a maximum speed of 105 MPH (with no tolerances). The 105 MPH maximum speed will be monitored with a GPS unit in each boat.

55.1 General Rules

55.1.1 Maximum speed 105.0 MPH without tolerance

55.1.2 A prop shaft release is mandatory

55.1.3 A cone shaped shaft collar must be affixed to the vessel, a maximum of ½" in front of the leading edge of the strut tube.

55.1.4 A GPS unit must be installed (out of the driver's reach) before each run on the water (testing or racing). It will be the owner's responsibility to see that it happens. The GPS will be checked by the inspector of the event or his appointed representative. GPS readings will be

included on the summary sheets.

55.1.3.1- It is the responsibility of the owner to have a working GPS onboard their vessel. This GPS should be a Garmin eTrex. Submit other model numbers to the IRC for approval.

55.1.3.2- It will be the responsibility of the driver to show the inspector the GPS speeds after each heat. Failure to show a speed will result in a disqualification.

55.1.5 Starts may be clock or flag starts. For flag starts, lanes will be drawn.

55.1.6 Because of the maximum speed, no straightaway records will be attempted.

55.1.7 Minimum weight, including driver and safety equipment, will be 1850 lbs.

55.1.8 A legal SE is recognized as a legal SA.

55.1.9 Capsule boats and non-capsule boats will run together at the discretion of the referee. If the referee separated then, the final position will be determined by time

55.2 Hull Configuration

55.2.1 The hull must conform to the racing runabout hull requirements as specified in the Technical Manual for Inspection of Racing Runabouts (Appendix A).

55.2.2 All fins shall be mounted between the chines on the underside of the boat.

55.3 Safety Equipment

55.3.1 Besides following all the APBA General Safety Rules for helmets and life jackets, it will be required for all open SA Boat drivers to Adhere to Rule 3.5.3 Drivers/Riders not in restraint capsules shall wear helmet support straps (lanyards) secured to the driver's/rider's body as required or a Head and Neck Restraint device. APBA will make no recommendation on which device to use. This solely on the driver.

55.3.2 All open boats require a kill switch.

55.4 Penalties for exceeding 105 MPH or not having a GPS

55.4.1 If it is found that a boat has exceeded the 105 MPH limit, by 1 MPH (105.1-106.0 MPH) the boat will receive a 1-minute penalty, a boat that exceeds 106.1 MPH will be disqualified for the heat.

55.4.2 Failure to have a GPS installed

55.4.3 If in a heat of racing, the boat will be disqualified from the heat. This boat may be used to fill the field at the referee's discretion.

55.4.4 If a boat is testing without a GPS

55.4.5 1st offense \$100.00 fine paid to the sanctioning club

55.4.6 2nd offense \$500 fine paid to the sanctioning club

55.5 Engine

55.5.1 Engines must be normally aspirated, no superchargers or turbochargers, no forced induction of any type, and no nitrous injection of any type.

RULE 56 GRAND NATIONAL (GN)

56.1 ENGINE, BOAT AND SAFETY REQUIREMENTS

56.1.1 It is recommended that fuel lines should be seamless rubber, synthetic rubber or plastic, providing any of these materials are reinforced with braiding or webbing (internal or external).

56.1.2 It is recommended that no non-reinforced hoses will be used anywhere in the pressure system. All fuel tanks will be vented overboard. Fuel lines will be secured in a workmanlike manner. All fuel lines on the pressure side of the fuel system shall be swedge type fittings or two hose clamps where push-on fittings are used. There shall be no glass components in the fuel system.

56.1.3 P&G Inspection will be the accepted official method of measuring cubic inches of engines.

56.1.4 A device which uncouples the engine and propeller shaft in the event of an engine failure which causes the engine to "lock up", is mandatory. Such a device must function automatically.

56.1.5 Drive shaft (torque tube) shall be completely enclosed, including U-joints. Recommended specifications are: ¼ inch thick aluminum of no less than 45,000 psi tensile strength, or 3/8 inch of 35,000 psi or 1/8-inch steel of 90,000 psi, or 3/16 inch of 35,000 psi.

56.1.6 All boats must be equipped with positive return throttles, ensuring an engine idle condition when throttle pressure is released or with throttle cable detached.

56.1.7 Wings will be secured and safety inspected.

56.1.8 No loose gear shall be in the cockpit at any time.

56.1.9 All Endurance events shall include a rigid safety inspection. Note that this inspection is in no way to be construed as verifying your craft is legal for the class in which it is entered nor in lieu of your due diligence in maintaining your entry in safe racing condition. At minimum, boats will be inspected for the following general condition:

- Rudder fastening
- Seat fastening
- Wiring
- Steering, cable, pulley, brackets, seat, rod-ends, and general overall condition
- Fuel tank mounting
- Wired or lock-netted turnbuckles
- Obstructions that would prove detrimental to the safe operation or abandonment of the craft.
- Securely fastened bow eye or tow hook.

56.1.10 It is strongly suggested that boats shall be equipped with a securely fastened paddle and a 10-foot tow rope of 2,000-pound test strength attached or stowed.

56.1.11 Fuel shall be restricted to any type of gasoline. This includes marine, aviation, or automotive racing gas. E-85 is approved to be a legal fuel in the IE Category, the fuel must be less than E-90 tested by the Quick Fuel Water Test Part #36-E-85.

56.1.12 NO additive power boosters will be permitted.

56.1.13 All boats must be equipped with a positive safety switch that will break the ignition circuit in the event a driver is thrown from his boat, and switch shall be properly attached to driver prior to starting the engine. A break-cable or release must not be more than 10 pounds pull maximum.

56.1.14 Non-Destructive Testing (NDT), such as magnetic particle, dye penetrate, or other processes is recommended annually for propellers, shafts, couplers, rudders, skid fins, brackets, struts, and other critical hardware. In the event of an accident, it is recommended that NDT be performed prior to competition.

56.1.15 Couplers and Safety Collars: Couplers between the gearbox shaft and the propeller shaft on runabouts shall be a minimum of 4.75 inches long and utilize a minimum of five (5) clamping bolts. Set screws shall be used in each end of the coupler or at least one (1) clamping bolt on each shaft must pass tangentially through the shafts. Each shaft shall be dimpled or grooved to accept these bolts or set screws. In addition to the required safety collar between the coupler and the shaft log, a safety collar of the propeller shaft, within 0.5 inches of the leading end of the strut, is mandatory on all Grand National classes. Safety collars must be configured so they will prevent the shaft and propeller from sliding back and hitting the rudder. Safety collars shall be machined from steel bar stock, no pressed metal (sintered iron).

56.2 STARTS, DISQUALIFICATIONS, FLAG SIGNALS, COURSE AND RACE SAFETY

56.2.1 The course shall be laid out in reasonably protected waters free from debris and turns are practicable. The finish line shall be at the starting line. Each lap will not be less than one mile. When possible, all starts will be "dead in the water" or modified "LeMans" type. The race timing begins and ends at the start/finish line after at least one turn has been rounded. In the event a clock start is used, standard inboard clock start rules will be used, except that jumping the gun will result in a one-lap penalty. The starts will be fully explained at the drivers' meeting. Starts differing from these, such as pace boat starts, may be used providing permission is granted by the Chairman of the Inboard Endurance Racing Commission or the Regatta Race Committee with unanimous drivers' consent.

56.2.1.1 During the LeMans start after the one-minute notice for the start of the race, you may not start your engine until the start flag drops. A one lap penalty will apply.

56.2.2 Maximum number of boats to be run on the following courses:

56.2.2.1 One mile course – 20 boats

56.2.3 The number of boats in Rule 4.7.2.2 may be adjusted by the Referee, if in his judgment, the course is wide enough to accommodate more boats or narrow to a point that would make excessive numbers of boats hazardous.

56.2.4 When the winning boat crosses the finish line, all boats will complete the lap they are on and be scored for the same.

56.2.5 Any boat breaking down on the course may take a tow without penalty and any may re-enter the race after repairs have been made. A boat may enter the race course anytime during the race and be scored accordingly.

56.2.6 There shall be no limitations as to repairs. However, complete change of engine or boat after the race has officially started is not permitted. A boat or engine may be changed between heats or days of racing, unless prohibited by the rules posted for "special events".

56.2.7 Any boat taking a tow must negotiate on the outside of the course to the pit, or the closest ramp or designated pick-up area from the point of pick-up.

56.2.8 Any boat drifting into the infield after breakdown and subsequently regaining power may continue the lap by re-entering the course from the approximate point where the boat left the course.

56.2.9 Any boat under power of under tow which for any reason cuts across the infield at any point for purpose of making a pit stop shall be disqualified.

56.2.10 In the event of a rescue operation or danger on the course, a caution flag may be flown. Colors are to be designated by the race officials (blue and white diagonal preferred). Race will continue as usual, but drivers must drive wide and slow down in accident area. Driver's failure to be cautious or driving in a hazardous manner in the accident area can cause a one-lap penalty or complete disqualification if, in the opinion of the Referee, such driving warrants such action.

56.2.11 Scoring shall continue under caution flag condition. At the conclusion of a rescue operation or elimination of a dangerous condition or situation on the course, a GREEN flat will be flown to so indicate, and the race will then be continued as normal.

56.2.12 The race may be completed under the caution flag.

56.2.13 All flags are to be explained at the beginning of the driver's meeting.

56.2.14 A penalty of one (1) lap shall be assessed for damaging, dislodging, or missing a marking buoy unless forced to do so by another boat in which case the other boat shall receive the penalty.

56.2.15 If a buoy is missed, the driver shall be obligated to circle back and pass the buoy on the proper side or receive the above stated penalty of one (1) lap. On race courses with single pin turns or no infields, circling back to pick up missed buoys is not permitted.

56.2.16 Disqualification infractions include, in addition to violations of all rules, the following:

56.2.16.1 Any U-turn on the race course

56.2.16.2 Running the wrong way on the race course

56.2.16.3 Helmets and Life Jackets: A driver (and passenger, if any) when operating registered equipment at any time while at a sanctioned regatta, must wear complete safety equipment, including helmet and life jacket.

56.2.16.4 Failure to fasten chinstraps or cups, leg straps or safety switch before leaving pits or any time on the course.

56.3 STOPPING THE RACES-RESTARTS

56.3.1 Restarting the race after a discontinuation following rules apply:

56.3.1.1 If 50% of the laps have been completed by the lead boat, the race committee may declare there will be no restart and the race shall be declared finished. In some cases, prize money will be paid on the basis of laps completed.

56.3.1.2 If less than 50% of the laps have been completed, the race may be restarted that day if conditions allow

56.3.1.3 In the event a race is stopped prior to the completion of 50% of the total laps and the sponsor deems it necessary to cancel any attempt to restart on the day or on a succeeding day.

56.3.1.4 In the case of a restart, boats shall line the beach according to the position held and proceed to have a modified LeMans style start. If this is not possible, boats shall leave the pits in their order of position in the race, under a caution flag, with the leader setting the pace. When all entries have had sufficient time to fall-in under the caution flat, the Race Chairman, at his discretion, will call for a GREEN flag to signal the official restart.

56.3.2 The following rules apply to a boat or boats that cause a race to be stopped due to a flip, etc.:

56.3.2.1.1 They will receive an automatic 3-lap penalty.

56.3.2.1.2 Boat must be inspected for safety before re-entering the race.

56.4 SCORING REQUIREMENTS

56.4.1 Scoring for each boat shall be, at the discretion of the race committee, either accomplished by official scoring designees or assigned to an individual selected by each boat owner.

56.4.2 If requested, each entry must furnish an acceptable scorer who shall report to the Chief Scorer.

56.4.3 All individual scorers are to be considered a crew member of the boat they represent. The actions and conduct of the scorer can reflect directly upon the boat they are scoring, causing penalties of their particular entry. They will be governed accordingly by the Chief Scorer or Referee.

56.4.4 Scorers must record each official lap in the official score sheet at the time displayed by the official clock. Each scorer must turn in a score sheet to the Chief Scorer at the conclusion of the race or the scorer's entry will be disqualified.

56.4.5 Scorers shall be subject to discipline by the Referee as recommended by the Chief Scorer for the event. Any scorer deemed guilty of misconduct, disruption, or acts of unsportsmanlike conduct in or about the scoring area may cause disqualification of the scorer's entry and be subject to further discipline.

56.4.6 Other scoring systems may be used provided prior permission is granted by the Chairman of the Inboard Endurance Commission.

56.4.7 Should the race be stopped for any reason and less than 50% of the scheduled racing has transpired, the Inboard Endurance Commission shall make a decision as to whether to award National High Points after reviewing the facts with a majority of the commissioners.

56.5 RACE QUALIFICATIONS

56.5.1 An endurance race must be run on a closed course under one of the following formats:

56.5.1.1 100 miles or more

56.5.1.2 20 lap duration which may comprise two (2) lap heats with point accumulation to determine the final order of finish.

56.5.1.3 5 miles

56.5.2 Grand National must have a minimum of three (3) bona fide starters (must legally start the race).

56.5.3 Any boat that starts a race by distance or time will be given points for the complete event according to the boat's finish although the boat need not be running at the end of the race.

56.5.4 Each boat that makes a legal start will receive a minimum of 40 points.

56.5.5 If more than one heat is run a day, the scorer will add points from all heats together. The final position for the day is then based on total point accumulation for the day, with 100 points the maximum for one day of racing.

56.6 TIME TRIAL AND RECORDS

56.6.1 Any boat, to be eligible to compete in time trials for records, must first qualify by finishing third or better in an Inboard Endurance race within the previous 12 months. Qualifications may also be made at the same regatta on the same weekend as the time trials are being held.

56.6.1.1 To qualify, a GN boat must have permanently attached fuel capacity of fifty (50) gallons.

56.6.2 The following records can be established:

56.6.2.1 Kilo

56.6.2.2 1 Hour

56.7 INBOARD ENDURANCE TECHNICAL RULES GRAND NATIONAL (GN) DIVISION

56.7.1 Any hull meeting the General Endurance Racing Rules, providing the overall length is not more than 25 feet down the centerline, including extensions, will be acceptable if determined to be safe and manageable. Strakes (breaker strips) of not greater depth than 1-1/2 inches and running in a fore and aft direction, shall be allowed.

56.7.1.1 The keel of the boat cannot be more than 1 inch above the chine. The bottom configuration cannot produce a tunnel hull of a depth greater than 1 inch. No hydroplane or step-type hulls will be allowed and at no time can the strakes fore and aft, with no restriction, be over 1-1/2 inches in depth.

56.7.2 Only one (1) inboard engine mounted rear of amidships, driving an external propeller through a stationary strut, using a V-drive mounted forward of the engine to transmit power through a straight drive shaft to a propeller shall be permitted. Steering is to be accomplished using a blade rudder mounted rear of the propeller and rotated to affect steering. Gearboxes shall be permitted.

56.7.3 **Definition of Grand National (GN) Division:**

56.7.3.1 Allowable engine designs will consist of the following American made automotive or light truck engines, including aftermarket parts:

56.7.3.1.1 Chevrolet big block-based engines must use cylinder heads designed and machined for use with a 4.84" bore spacing. Heads with symmetrical intake ports are not allowed.

56.7.3.1.2 Chrysler B/RB based engines with non-hemispherical combustion chambers must use common wall intake port cylinder head designed and machined for use with a 4.8" bore spacing.

56.7.3.1.3 Chrysler Hemi-based engines with hemispherical combustion chambers must use cylinder heads designed and machined for use with a 4.8" bore spacing.

56.7.3.1.4 Ford "385 series" based engines must use wedge style heads designed and machined for the standard 4.9" bore spacing.

56.7.3.2 Naturally aspirated, 557 cubic inches, max

56.7.3.3 Cast iron engine blocks only. Aluminum heads are allowed.

56.7.3.4 A maximum of 2 valves per cylinder is allowed. No overhead cams allowed. Any form of carburetion or fuel injection is allowed. All supercharged intake manifold bases must be cast for a minimum distance of 3" from the intake to cylinder

head interface or spacer plate; except the 545 NA engine can run a sheet metal intake manifold. No restrictions on valve train or oiling systems.

- 56.7.3.5** Other manufacturers' engines will have cylinder head guidelines developed for them as the need arises.
- 56.7.3.6** Forced induction (with blower), 475 cubic inches max. All other naturally aspirated engines and cylinder head rules apply.
- 56.7.3.7** Blower design, size and overdrive limited to the following options:
 - 56.7.3.7.1** GMC 6-71 design series (includes aftermarket replacements in 6 through 14-71 sizes). Only standard helix rotors will be allowed (max. 4 degrees of twist per inch of length). Whipple Marine Screw Compressor with STD 1:36 pressure ratio discharge (compressor will be certified and stamped "GN" from the factory at Whipple).
 - 56.7.3.7.2** Sizing baseline for all blowers will be a STD 8-71 driver at 1:1 crankshaft speed, which is 470 cubic inches of air per revolution of 7.7 liters of air per revolution. 14.7 @ 0.80:1 or 10.7 @ 0.92:1 or 6.7 @ 1.08:1 or 3.0 liter Whipple @ 2.5:1 (7.5 liters per revolution) or 3.8 liter Whipple @ 2.0:1 (7.6 liters per revolution). Whipple Superchargers will run race gas or pump gas ONLY – NO E85.
 - 56.7.3.7.3** Forward facing blower drives must have belt covers.
- 56.7.3.8** The commission will address the parity of the two engines options by adjusting the blower size/overdrive limits (up or down) as required to maintain the competitive nature of the naturally aspirated vs. each of the forced induction packages.

RULE 57 COMPETITION JET (CJ)

- 57.1** V bottom hulls only.
- 57.2** A maximum overall length of 24 feet, including pump and extensions is allowed.
- 57.3** Hull depth would be a maximum of 28" from keel to deck seam.
- 57.4** Hull deadrise angle to be a maximum 20* or 40* total angle at the transom.
- 57.5** All boats must be equipped with a minimum of two (2) visible continuous stringers from transom to bulkhead.
- 57.6** The drivers seat and frame must be thru bolted to at least one (1) stringer (No Lag Bolts allowed).
- 57.7** The engine will be mounted to the stringer also.
- 57.8** Power to be supplied by one (1) U.S. built automotive or light truck engine, including aftermarket parts, with a maximum displacement of 515 cubic inches. OEM Aluminum Blocks are allowed with a maximum displacement of 475 cubic inches and a maximum bore spacing of 4.400". Aftermarket Aluminum Blocks are not allowed.
 - 57.8.1** Chevrolet big block engines must use common wall intake port cylinder heads designed and machined for use with 4.849" bore spacing.
 - 57.8.2** A maximum of two (2) valves per cylinder is allowed. No Overhead Cams allowed. No restrictions on valve train or oiling systems. All intake manifold bases must be cast for a minimum distance of three (3) inches from the intake cylinder head or spacer plate
 - 57.8.3** Engine will be bolted and mounted forward of the Jet drive.
 - 57.8.4** Engine will be Naturally Aspirated; any form of carburation or fuel injection is allowed.
- 57.9** Single Jet Drive Only, used for marine application only.
- 57.10** No Jet-a-Way or Driveline shield/guard required
- 57.11** Impeller and impeller housing must be mounted above keel as measured at centerline.
- 57.12** Must be equipped with a turning rudder with a minimum of sixteen (16) sq. inches and extend at least four (4) inches below the lowest point of the jet nozzle.
- 57.13** Place Diverter or Jet-O-Vator adjustable nozzles may be used. A positive diverter stop is required, and a rooster tail will not exceed four (4) to five (5) feet above the water line. This includes all fixed nozzle boats. The diverter shall remain in the full down position at all times on or near the launch ramp or pit area. Failure to do so in the opinion of the referee will result in a one (1) lap penalty.
- 57.14** A thru bolted loader will be securely attached to the jet intake using four (4) 5/16" black oxide or grade eight bolts.
- 57.15** The driver must be seated forward of the engine.
- 57.16** Competition Jets will maintain their respective lanes from the Start of the race through the first turn. The lead boat must ensure that a four (4) boat length overlap condition applies prior to changing lanes. A violation of this rule in the opinion of the referee will result in a one (1) lap penalty or disqualification.

RULE 58 CLASSIC CLASSES

- 58.1** **Classic Endurance**
 - 58.1.1** Any hull built before 1982 or splash off of a hull built before 1982, with a length not more than 23'. This will include flat bottoms, v-bottoms, runner bottoms or tunnel bottoms.
 - 58.1.2** Any powerplant, gas, diesel, with carburetors, injectors, blowers, turbochargers. No nitrous.
 - 58.1.3** Propulsion systems include direct drive, v-drive, in/out, outboard, and jet.
 - 58.1.4** A cone shaped shaft collar must be affixed to the vessel, a maximum of 1/2" in front of the leading edge of the strut tube.

58.2 Classic Flatbottom

58.2.1 Same requirements in year built and less than 23', flat bottom, runner bottom.

58.2.2 Engines, gasoline only. Any carb/induction/blower/turbos.

58.2.3 Propulsion system to include direct drive or v-drive.

58.2.4 A cone shaped shaft collar must be affixed to the vessel, a maximum of 1/2" in front of the leading edge of the strut tube.

58.3 Classic Jet

58.3.1 Any jet hull built before 1982 or replica.

58.3.2 Engines, gasoline only. Any carb/induction/blowers/turbos.

58.3.3 Any jet propulsion drive. The drive will not utilize any jet-o-vator that impairs driver visibility for a following boat.

58.4 Speeds

58.4.1 Maximum speed of 85.9 MPH as recorded by a handheld GPS unit affixed to the boat or driver.

58.4.2 The GPS unit will be examined prior to the start of each individual heat and immediately after that heat. If the GPS unit does not register any speed or an obvious lower speed, that competitor will be penalized one (1) lap.

58.4.2.1 Additionally, if the speed recorded is 86-88 MPH that competitor will be penalized one (1) lap.

58.4.2.2 If the speed is faster than 88 MPH that competitor will be disqualified and at the discretion of the race officials will not compete in the classic class for the remainder of the event.

58.5 Safety and Sportmanship will be paramount and fostered at each and every event.

58.5.1 It is the intention and goal of the "Classic" classes and competitors to have a safe and rewarding experience, and to allow as many Classic racers to bring what they have to race.

58.5.1.1 It will be the competitor's responsibility to have equipment that will pass a safety inspection prior to each event as required by race officials.

58.5.2 The "Classic" classes will be run as a local class through a sanctioned event. Any questions or additional requirements will be addressed through the sanctioning organization(s) prior to the event.

APPENDIX A • Technical Manual for Inspection and Measurement of the Racing Runabout

The purpose of this manual is to provide uniform review of the Runabout Hull Requirements. Included are methods, tools and devices for hull inspection, and sketches of areas that must be measured. It is intended as an inspection and measurement guide, so that on a National level we can provide uniform thinking.

Since it is almost impossible to consider every measurement combination that may arise or answer every question, you are encouraged to contact the Hull Committee Chairman whenever in doubt and request a ruling. **MOST IMPORTANT**, do not accept verbal rulings, interpretation or opinions. Insist upon a written copy of any question regarding these rules. Only those rules as written in the Inboard Runabouts section of the rule book, plus your specific class rules, will apply.

Remember that hulls, regardless of make, manufacture or design, are like engines. Each is subject to inspection on a separate basis. In other words, simply because one hull was inspected, that does not mean that all of the same design or manufacturer are legal. Any hull is subject to reinspection at any regatta, just as an engine would be. It is your obligation to see that your hull conforms to the rules. **MEASURING TOOLS:** The following list includes suggested basic tools or devices that will help in measuring a hull. Substitute methods or tools may be used as long as they produce similar results.

- 1 - Plumb Bob.
- 1 - Depth Micrometer with 4" Range.
- 1 - Asst. Marking Pens.
- 1 - Set Twist Drills - 1/32 to 1/2 inch Dia.
- 1 - Aluminum Straight Edge - 3/8" thick x 2" wide x 6' long.
- 1 - 20' Steel Measuring Tape
- 1 - 2' Level (Carpenters).
- 1 - 12" Straight Edge.

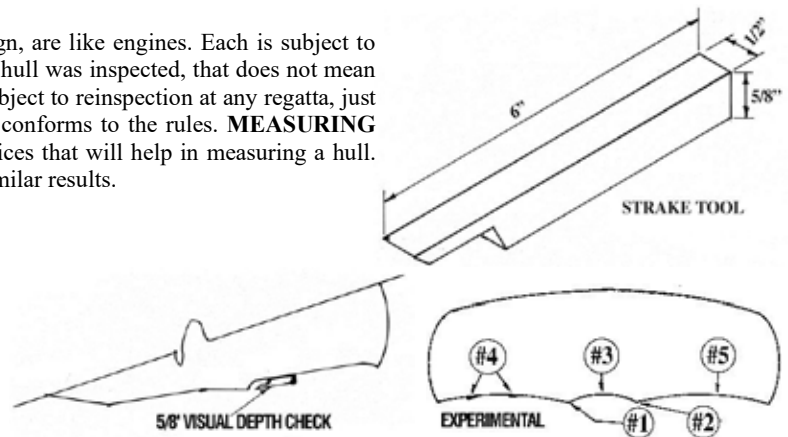

- 2 - Wood Blocks (oak or mahogany), 6" long x 5/8" wide x 1/2" thick.

NOTE: Shape one end as shown. This can be used to quick check strake depth, where radius or angles interfere with other measuring devices.

2 - Each 1-1/4" and 5/8" round dowels, steel rods, or rigid copper tubing about 5" long.

NOTES: If wood is used it should be sealed with one or more coats of sealer. The above suggested copper tubing is available at most hard-ware, plumbing or refrigeration shops. Use ridged type, cut to size, deburr, and Mic., to allow out of round tolerance in final measurements. See *Illustration*

PRE-MEASURING NOTES: The drawings in this manual are not to scale.

49.10 When inspecting or measuring a hull that incorporates more than one or two parts of the rules, each shall be measured separately to assure compliance with each rule. Example:

1. A flat (wide) keel area.
2. A strake in the flat keel area (runner).
3. A concavity in the flat keel area.
4. A series of strakes.
5. A concavity to each side of the keel. (*See Illustration*)

49.11 Any clarification of this manual or the rules shall be made in writing to the Chairmen to all Runabout Classes. Any interpretation that are required to be made in writing shall be approved by a majority of the Hull Committee membership. Interpretations or clarification shall not change the intent of any rule.

49.12 Skid and Turning Fins and Struts shall not be included in any measurement nor are they considered at present under the rules.

49.13 There is no tolerance allowed for warpage, settling, etc.

49.14 MEASURING AREAS: The Inboard Runabout Rules require that given dimension must be maintained in three areas of the hull bottom. For the sake of clarity they will be referred to as "Measuring Areas". Those areas are as follows:

49.14.1 IMMERSSED SURFACES: These are all surfaces of the bottom of the boat that would be under water when the crew and fuel are aboard and the boat is at rest in the water. If necessary to perform inspection, make reference marks on the hull before it is removed from the water.

49.14.2 TRAILING EDGES TO AMIDSHIP: These are all surfaces of the bottom of the hull beginning with the aft (rear) major edge of the cavitation plate less any projections to amidship. To determine this surface and the amidship line proceed as follows.

- | | |
|------------------------------------|----------|
| Measure total length of hull | a. _____ |
| Measure length of cavitation plate | b. _____ |
| Total of above | c. _____ |
| Amidship equals 1/2 of above total | d. _____ |

Or: simply measure overall length of hull and plate F. shown in illustration is 1/2 that length.

Note: Aft or rear edge of plate is from major trailing edges, not from rear of any projection etc., as in sketch.

49.14.3 TRAILING EDGES TO 54" FORWARD: These are all surfaces of the bottom of the hull, beginning with the aft (rear) major edge of the cavitation plate, 54" forward of that point. To determine this surface and line proceed as follows:

Measure forward (toward bow) 54" from major trailing edge of cavitation plate. This is 54" line as required for inspection.

NOTE: Projections from major trailing edge of cavitation plate are not to be considered.

NOTE: When determining the amidship line, it is necessary to find the length of hull and/or length of hull and cavitation plate. Two methods are suggested below; use any that produces the same result.

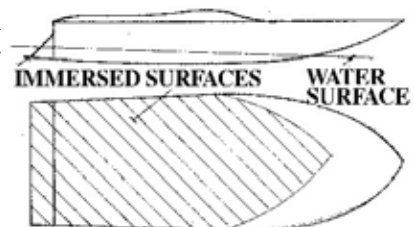

49.14.4 A simple method of determining hull length when engine height blocks interferes with measuring tape, is to use two straight edges and a level. Place one straight edge with level along transom. Have a crew rise or lower tongue of trailer, until bubble in level is centered. Leaving trailer set in that position, use another straight edge at bow, and again level or center bubble in level. Use tape to measure between both straight edges. (See Illustration)

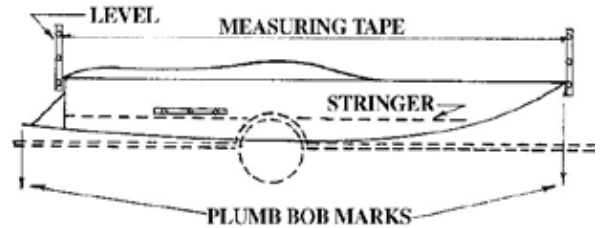

49.14.5 An alternate method is use of a Plumb Bob. First place level on stringer. Crank or block nose of trailer until stringer is level. Drop Plumb Bob line from cavitation plate to ground and bow to ground. Mark ground at both spots. Use tape and measure marks to determine total overall length of hull and plate. Remember one half that total length is the amidship line. (See Illustration)

49.15 The following references are numbered exactly to match the rules as printed in the rule book. The rules are not repeated in this manual. The following simply elaborates or further explains those rules.

REMEMBER: Refer to current rules as printed in the rule book and then information below.

RULE #1, including section(s) a. - "HULLS":

RULE #1. Displacement or monoplane type hull: essentially displacement hulls move aside or displace a certain amount of water. Monoplane - a hull with one main supporting surface. These are hulls with one main supporting or riding surface that displaces water. No sponsons or other devices are allowed that would shift that support to other than one main supporting or riding surface. Other section of the rules specify tolerances for strakes, keels etc.

RULE #1 SECTION a. (Self Explanatory) Hulls must have fore and aft decks. Together they must total 1/5th of the total length of hull. In example, a 20' hull would require a minimum of 4' of deck.

RULE #2, including sections a. b. c. d. e. f. and g. - LONGITUDINAL OR TRANSVERSE BREAKS:

RULE #2. Measuring Area - "All Immersed Surfaces" Longitudinal or Transverse Breaks: This rule repeats the basic requirement of monoplane design - No steps, breaks. It does however, provide allowances for keel and strakes within the limits as specified under section a. thru g. to follow.

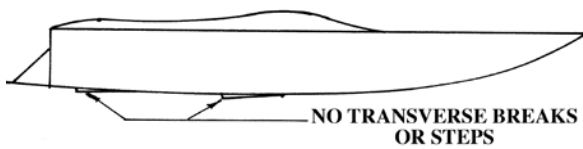

entire immersed surfaces, including cavitation plate for maximum 5/8" depth. See Illustration.

There is NO allowance for transverse breaks, other than Rule #2 section g. and Rule #5 section c. Transverse breaks as defined in Webster's would be breaks that would lie across the hull.

Inspect entire immersed surfaces for same, including cavitation plate.

RULE #2 section a. Measuring Area - "All Immersed Surfaces" Keels and strakes may run only in fore and aft direction. They can be no more than 5/8" deep. Inspect

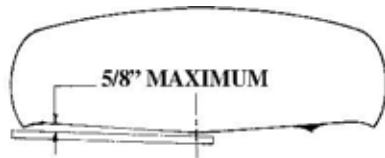

On flat hulls a straight edge and depth Mic. can be used as shown at left.

A quick check can be made with the 5/8" wood gauge notched to clear radius as shown.

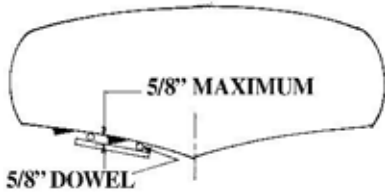

If hull is concaved as shown, strake depth can better be checked using a 12" straight edge and 5/8" dowels. Place dowels so that they are in highest portion of concavity, with straight edge across same. Straight edge should be able to touch both dowels without strake interference.

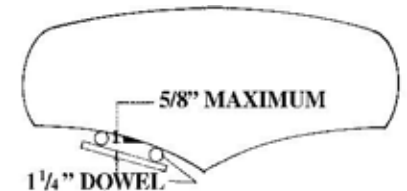

If dowels are thicker, such as 1-1/4" there should be no less than 5/8" gap or space between straight edge and strake.

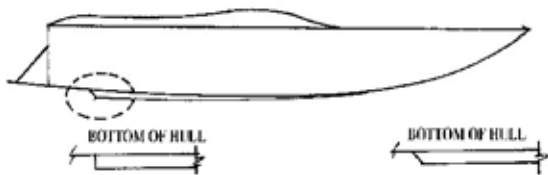

On hulls with a flat keel, a strake is allowed in that keel area. (This is commonly referred to as a runner or runner type hull). However, this strake or runner may not exceed 5/8" depth. Measure with straight edge as shown. See rule #3 section a. and b. for additional details on this type of hull.

Measure depth as close to runner as possible.

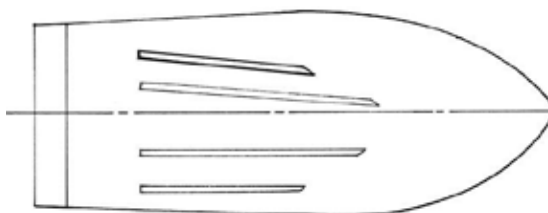
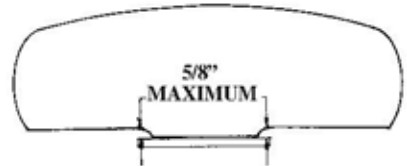

RULE #2 section c.: Measuring Area - "All Immersed Surfaces" Strake termination shall not form a transverse break. They must end at no more than 45 degree angle to bottom. Inspect as below, on all immersed surfaces including cavitation plate. Check all strakes and breakers, including those that fall on keel on chine. (See Illustration)

RULE #2 section d.: Measuring Area - "Trailing Edges To Amidship" Keel must be lower than chines in this area. Inspect as below, from trailing edges of cavitation plate to amidship line.



The two examples at left display illegal hulls - the keel is higher than the chines. Note space between keel and straight edge. Remember- it is permissible to add keel strip etc. to bring hull into proper configuration.



This example at right shows a legal hull, as straight edge can touch keel.



RULE #2 section e.: Measuring area - Trailing Edges to 54" Forward Strake depth shall not prevent a straight edge from touching keel and chine.

Inspect as below in entire 54" area including cavitation plate. Strake or any part of it must not interfere with straight edge, touching both keel and chine at same time.



The top two examples at left show illegal hulls, as straight edge cannot touch both keel and chine strakes interfere with straight edge. Note gap.



These are two legal configurations at left.

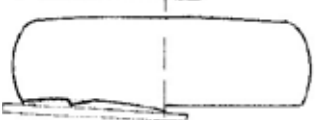

Note that straight edge can and does touch both keel and chine. There is no gap.



The last example shows hull with flat keel. When measuring this type hull, straight edge must touch chine and outside edge of flat keel area, to meet requirement of Rule #2 section e. See rule #3 for further details.

RULE #2 section f.: (Self explanatory) there is no limit on number or width of strakes. And they can run to trailing edges which includes cavitation plate.

RULE #2 section g.: (self-explanatory) is provided so that a 1/8" recess across the hull (transverse direction) can be made for attaching hardware, struts, fins, etc. See sketch under Rule 5 section c. for example sketch showing cavitation plate attachment.

RULE #3, including sections a. and b.: - FLAT KEELS:

RULE #3: (Self explanatory) Keel need not be V or semi V shape and may be flat to right and left of centerline. Examples shown below may be used providing they meet requirements of section a. and b. below. Also see Rule #2 sections a. and e. and Rule #4 as those rules affect this type of hull. (See Illustration)

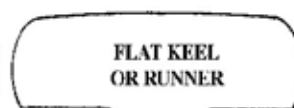

RULE #3 section a.: Measuring Area - Trailing Edges to 54" Forward. Outside edges of flat keel must be parallel to centerline. Inspect as below.

Edges that run other than parallel to centerline of keel:

Illegal if runout exceeds one inch per foot.

Centerline of hull

Legal if parallel to center line, or not exceeding 1" runout per foot. Illegal if runout exceeds 1" per foot.

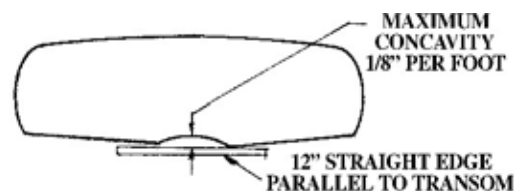

RULE #3 section b.: Measuring Area - Trailing edges to 54" forward. The flat or wide keel area may have concavity not to exceed 1/8" per foot. Inspect as below, use 1/8" drill bit and 12" straight edge to entire 54" area including cavitation plate. Maximum concavity 1/8 inch per foot.

RULE #4 including sections a. and b.: CONCAVITY: Measuring Areas - Trailing edges to Amidship

This rule is self explanatory, in that hulls may have a concave bottom on each side of center line. The concavity may not exceed 5/8". Sections a. and b. spell out how to measure this concavity, using below transom views as examples.

Inspect using straight edge placed on keel and chine or to any spray rail or strake attached to chine. Check in all portions, including cavitation plate. Concave radius may be even or uneven.



On the two top examples at left, measure all portions of concavity 5/8" max.



On certain hulls strakes between the 54" line and amidship line may interfere or not allow the straight edge to touch keel and chine to measure concavity. In this case block down straight edge with dowels - see example.

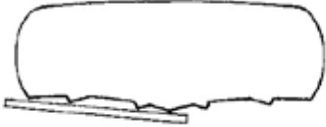

If using 1-1/4" dowels you will measure maximum depth of concavity and deduct 1-1/4" from your measurement.

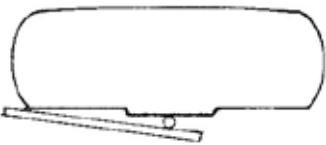

On hulls with a flat keel area, proceed as mentioned above. Using dowels to block down straight edge with one dowel on chine, and one in center of keel area. Take maximum depth and deduct dowel.

RULE #5 including sections a. b. and c.: - CAVITATION PLATES:

RULE #5 section b: Cavitation plates, even though separately attached and of different materials, are considered part of the actual hull. This rule requires that at any given foot or handle setting (your choice) the plate must meet all measuring requirements of the hull. This includes Rules #2, #3 and #4 and all sections of those rules.

To inspect, select one root or handle setting. At that given setting, measure the plate(s) for compliance with the rules and subsections. Stops are no longer required.

RULE #5 section c: This rule is self explanatory - however, a graphic example is at right. The 1/8" is allowed for fitting tolerance to hull.

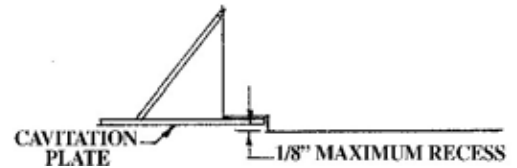

RULE #6 including sections a. thru e.: - DEFINITIONS:

Those definitions in the rule book will apply to this technical manual. In addition there shall be no tolerance to the 5/8" requirements. The maximum is .625".

49.16 HULL LIFTING REQUIREMENTS: It is your obligation to have some device, sling, or point in your hull to which the hook of a crane, backhoe, boat launch tram hook, tow truck hook, etc., can be attached, to safely lift your hull off the trailer for inspection. The inspector shall determine if this device, sling, or point, is capable of safely lifting the hull. Your boat can be declared illegal if you cannot meet this requirement for inspection.

APPENDIX B • Technical Inspection Manual and Guide to Measuring the Racing Crackerbox

The purpose of this manual is to provide a unified and simplified procedure to inspect the racing Crackerbox. This is a guide to be used as a minimum inspection procedure while inspecting the hull; and in no way supersedes the inspector, referee, or other binding authority's right to perform a complete inspection (including but not limited to lofting of frame work and hull dimension, measuring as specified in section 50.5 of the rule book). Rule 50 and rule 49 take precedent in any discrepancy with this guide. This procedure identifies a minimum of twelve points to be inspected of the more critical areas of the hull, verifying basic dimensional compliance as paraphrased in section 50.1 of the rulebook. **Suggested Tools** (these are recommended, similar tools may be substituted)

1- Aluminum Straight Edge 3/8 thick, 2" wide, 4' long (or equivalent)

1- 1/8" Dowel 2- 1/2" Dowels

1- Grease Pen

1- 20' Tape Measure

2- 2' Carpenters Level (two plumb bobs or equivalent may be used)

Note to Inspector: Prior to lifting a hull for inspection, verify that the lifting slings used are in compliance with rule 3.9 of the General Safety Rules. Additional references can be found in **Rule 49.8 Hull Lifting Requirements**.

Transom Definition: For the purposes of this Guide the transom will be the primary vertical plane at the stern of the hull. All measurements taken from the transom must be perpendicular to the transom (see fig. 1).

Transom Width Measurement: Point A

Measure the minimum and maximum distance across the transom perpendicular to the hull centerline. The minimum dimension is 55 1/2", and the maximum dimension is 59 6/8".

Note: That the 1" +/- tolerance as specified in section 50.5 TABLE OF OFFSETS does not apply to these dimensions. (See fig. 1).

Station #7: Point B and Station #4: Point C

Measuring perpendicular from the transom toward the bow, place a mark at 81 inches (Point B, Station 7) and at 123 inches (Point C, Station 4) on both sides of the boat. Use the markings at each point, along with two levels, to measure the minimum and maximum width of the hull at the chine at each station. The readings should be no less than 66 inches and no greater than 70 inches for point B (Station 7) and no less than 56 3/4 inches and no greater than 64 inches for point C (Station 4). (See fig. 2a and fig. 2b).

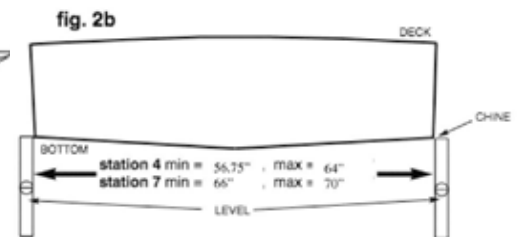
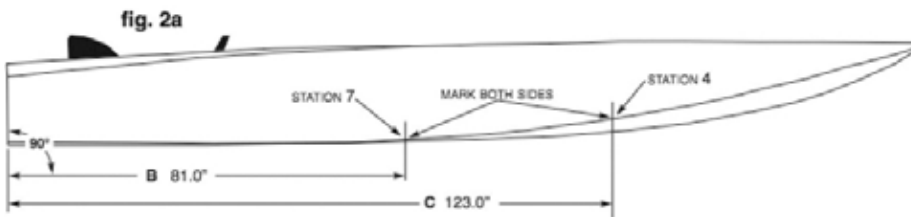

Overall Length: Point D

Measuring from the transom center to the tip of bow, the overall length of the hull should be no less than 13' 6" and no greater than 15' 6". Per rule 50.5.3 the adjustable plates are in no way to be included in the measurement of overall length.

When engine height or other deck attachments interfere with the tape measure, a simple method of determining hull length is to use two carpenters' levels or plumb bobs—one at the transom center and one at the tip of the bow. (See fig. 3).

If the measured value does not meet the requirements set out in rule 50.5.3 and the Inspector feels the issue is due to measurement error, the Inspector shall measure the length of the hull per rule 50.5.

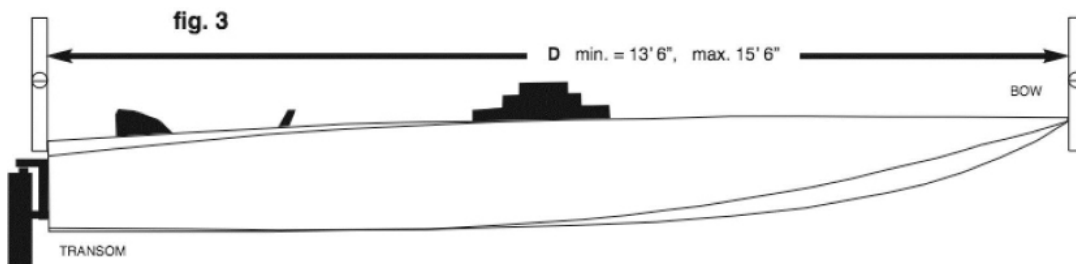

Concavity: Point E, F, G, H, I

With the hull suspended in the air in a safe manner as determined by the inspector, measuring perpendicular from the transom towards the bow, place a mark at 6 inches, 24 inches, 48 inches, 72 inches, and 93 inches on the keel centerline and on the chine on both sides of the hull (see fig. 4a). Place a straightedge flat on the bottom at the keel centerline to the chine at each marked location. Repeat this process on both sides of the keel. If space is observed between the hull's bottom and the straightedge, then use the 1/8 inch dowel to determine if it can be placed between the bottom and the straightedge. When measuring the bottom concavity, there will be a 1/8 inch maximum deviation from a theoretical straight line from the keel centerline to chine from the transom forward to amidships per rule 50.5.9. It should be expected that some underwater gear such as the strut, prop shaft shrouds, water pickups, etc. could interfere with getting a measurement to the keel centerline. In this case the inspector shall use his/her best judgment as to whether the device is hiding potential concavity. In this case, simply move the straightedge around the area and re-measure to achieve an accurate determination of the hull's legality. (See fig. 4b).

Note: If devices such as water pickups, mounting plates, blast plates etc. are mounted to the keel obstructing the centerline, an offset must be used to determine bottom concavity. For example, using two 1/2" dowels, place one on the keel centerline and the other on the chine. Place the straight edge across the dowels and take a measurement. The measurement should be no more than 5/8 of an inch. (See fig. 4b).

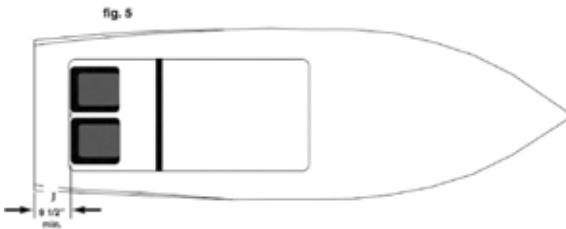
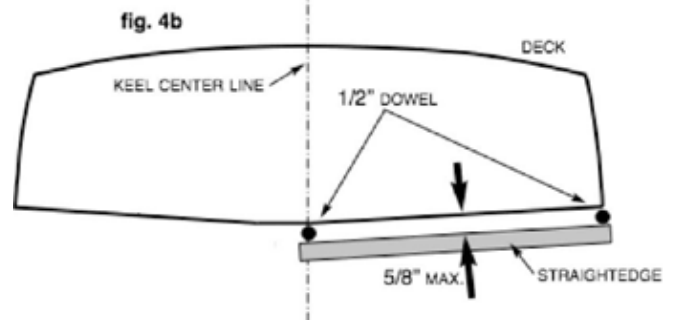
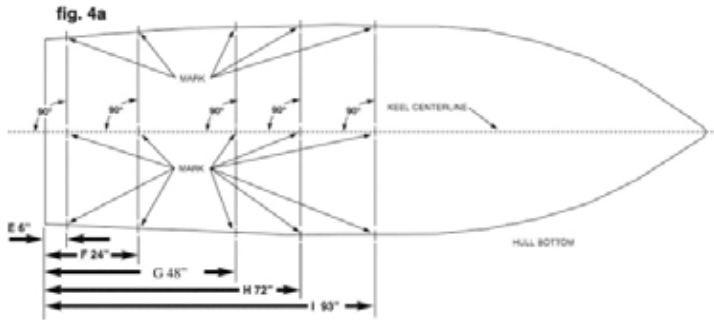

Seat Back: Point J

Measuring from the transom to the back of the driver's and rider's seats, there must be no less than 9 1/2 inches per rule 50.5.6 (See fig. 5).

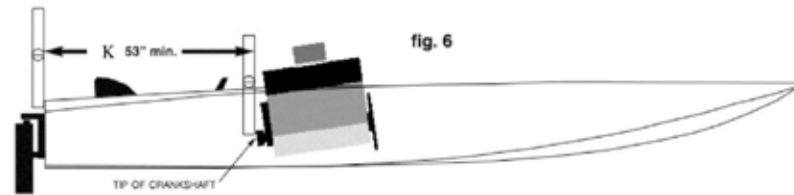

Engine Placement: Point K

Engine must be mounted in front of the cockpit and have a minimum distance of 53 inches perpendicular from the transom to the tip of the crankshaft per rule 50.5.5. A simple method of determining engine location is to use two carpenter's levels—one at the transom and one at the tip of the crankshaft (See fig. 6).

Visual Inspection: Point L

The bottom shall be visually inspected per rule 50.5 and 50.6. The adjustable plates should be blended or flushed to the bottom per rule 50.6.5. All other underwater gear must be mounted in accordance with rule 50.5.10 and 50.6 (See fig. 7 and fig. 8 below for examples).

