

**OPC SAFETY RULES**

1. Novice drivers must, for the entire one-year period of probation, tape or paint a 2" wide orange stripe on the rear of the motor cowling on the boat in which they are competing. The stripe must extend from the top of the cowling to the bottom and must be visible to other drivers while the boat is on the race course. Novice drivers must be given an oral examination by the referee or race committee. Novice drivers must show knowledge of course racing rules, to the satisfaction of the referee, before being allowed to enter a race. The following procedure will be followed by all novice drivers for their first event in the class group in which they are competing: If the start is a pace boat, clock, or any other form of moving start other than LeMans, the novice driver shall drive in a position at the rear of the "pack", while being observed by the referee and course officials. If the start is LeMans, the novice driver shall start at the position giving least advantage to the first turn regardless of any prior qualifying and must be delayed approximately two seconds at the start so as not to approach the first turn with the "pack." During the course of the race the novice driver must always pass all boats on the outside and give adequate room to be overtaken on the inside by all faster boats. If he is not cleared for "open competition" at the end of the race the referee shall not sign his temporary license and he will be required to run additional races in the same manner until the referee clears him by signing his temporary license. This rule is not to restrict or disqualify any UIM or CBF members or any other duly qualified and licensed driver.
2. During any race, every participant must wear a competition helmet and life jacket as defined in General Safety Rules 3A and 3B. Additionally:
  - A. Face shields and face guards are allowed if they permit ready access to the mouth for rescue purposes.
  - B. OPC strongly recommends the use of a helmet restraint system.
  - C. For non-restrained drivers: It is required that the life jacket (P.F.D.) be designed for racing with leg straps or thigh skins. The jacket shall have a minimum of 1/4" thickness of impact protection material covering the back and sides. It is strongly recommended to use a Flak material to cover the back and sides, as well. The skid collar shall contain a single piece of material equivalent to Ethofoam 1/4" thick minimum which covers continuously from the top inner edge of the life jacket to a minimum of 2" past the base of the helmet when the wearer is standing in an erect position with the head looking toward the horizon and the life jacket worn in accordance with manufacturer's instructions. The axial coverage shall be from 110° to 250° minimum measured from the midsagittal plane (basically from the back of the ear to the back of the ear around the back side of the head). The outer covering shall be any synthetic material which is fungus- and mildew-proof (e.g., nylon, Dacron, etc.) which is of thickness equal to or greater than the material used as the jacket covering.
  - D. Every driver shall verify his flotation before each racing season and after any equipment change to be sure he will roll into a safe attitude if injured. The referee may require proof of the equipment function.
  - E. When a participant is strapped in (restrained), he must wear a racing life jacket. It is recommended that this life jacket be designed with a ballistic covering and have approximately 10 pounds positive flotation. The life jacket must be equipped with epaulet type extraction loops on the shoulders. Buckle type straps across closures and skid collars are not permitted on any restrained driver's life jacket.
3. A suitable arrangement shall be installed capable of closing the throttle(s) when the driver's foot is removed from the throttle pedal.
4. Safety Stop Switches:
  - A. All non-driver restrained boats must be equipped with an electrical engine stop switch capable of stopping the engine, and electric fuel pump, if so equipped, if the driver is separated from the boat. A stop switch must consist of a line (plug, cap, etc., which must attach to parts inside the hull to facilitate continuous operation of the engine) and a tether less than four feet in length, with a switch activating force less than 30 pounds. All safety switch tethers must be permanently attached to life jackets by a breakaway device with a pull force greater than the switch operating force.
  - B. All reinforced cockpit boats must:
    - 1) Have switches for ignition, starter, and electrical fuel pump if so equipped, mounted inside the cockpit where they are easily actuated by the driver when he is strapped in.
    - 2) Have a positive on, positive off ignition switch for the engine as well as a similar switch for the electrical fuel pump if so equipped, mounted on the left (port) outside of the cockpit. No momentary switches are allowed for these requirements. All switches must be clearly labeled on the outside of the cockpit as Engine Shut Off and/or Fuel Shut Off. Both functions may be combined in a single switch and labeled accordingly. Looped tethers activating inboard mounted switches are allowed and such switches may be the same ones as required in (1) above. It is recommended these switches be mounted at the left upper rear of the capsule behind the driver's head.
    - 3) Have a centrifugal force actuated or inversion actuated shutdown switch. This switch must be mounted in the main cockpit area of the hull and be capable of disabling the engine ignition system and shutting down the electric fuel pump, if the boat is so equipped, when the boat is upside-down. It may be placed inside the driver compartment so that it may be easily reset in case of a complete roll; and it may satisfy the requirements of (1) above. This switch assembly must be easily removable for safety inspection purposes.
5. Engines must be bolted to transoms.
6. Anyone starting or running any outboard motor over land or dock with the propeller, prop nut, washer(s) or thrust washer on the lower unit may be disqualified for up to thirty (30) days.
7. Pre-Race Safety Inspection: The local Race Committee may have one of its members or another qualified representative make an inspection previous to the start of every race of all boats to see if requirements of these rules and the circular of conditions have been complied with. An inspection of each entry may be made by the Race Committee to determine whether the boat is seaworthy, of safe construction and that all mechanical devices for steering, throttle, lifting bridle, etc. are in good and safe

working order.

At a boat's first race of the new season, the equipment is given a full inspection. If all equipment passes the inspection then a vinyl safety inspection sticker, specifying that racing year, is permanently attached to the starboard side of the cockpit. The rest of the year, as long as the decal is attached to the boat, the depth of the safety inspection is at the inspector's discretion.

A. Items to be checked each time should include the following:

- 1) Safety stop switch
- 2) Helmet, jacket, and seat belts
- 3) Steering system
- 4) Head clearance

8. Flotation requirements for OPC boats:

A. OPC boats must contain the volume of permanently attached flotation foam listed in the following table C. Two (2) pounds per cubic foot, closed cell, U.S.C.G. approved flotation foam is recommended. Its volume should be easy to measure for purposes of inspection.

B. If a reinforced cockpit/driver restraint system is used, the cockpit structure must include the listed volume of same foam. It must be capable of floating the cockpit, driver, engine and any other attached structures. The foam must be permanently attached (i.e. glassed in) to the rear area of the cockpit.

C. Foam Requirements for flotation purposes only (approximate):

<u>Classes</u>	<u>Total Cu. Ft. of Foam in Boat, Including Cockpit</u>	<u>Cu. Ft. of Foam in Reinforced Cockpit Structure, If So Equipped</u>
Sport C	4.0 CF	2.0 CF
SST 45	4.0 CF	2.0 CF
SST 60	5.5 CF	3.5 CF
SST 120	6.0 CF	3.5 CF
SST 200	6.0 CF	3.5 CF
Mod U under 2800cc	6.0 CF	3.5 CF
Mod U over 2800cc	8.0 CF	3.5 CF
Formula 150	6.0 CF	3.5 CF
Formula 1	6.0 CF	3.5 CF
GT-1	6.0 CF	3.5 CF
Super Sport	10.5 CF	4.5 CF
Sportsman Mini GT	2.0 CF	-
Sportsman GT Pro	3.0 CF	-
Formula Tri-Hull	6.0 CF*	-
VP 75	6.0 CF	3.5 CF

\*(including sufficient foam to float roll bar)

D. Boat manufacturers cannot count construction materials when calculating foam flotation requirements. Foam flotation will be added in the properly designated areas in the boat. (See Figure AA).

E. The inspection of the boat for proper flotation as specified in OPC Safety Rules may be accomplished by one of the following procedures:

- 1) Physical inspection and measurement by the inspector;
- 2) A notarized statement signed by the registered owner or driver of the boat that states the boat meets the requirements of OPC Safety Rule 8 (A-D). This statement must be permanently affixed to the hull and protected from water damage, etc.;
- 3) Certification by the boat manufacturer that the boat has been constructed in accordance with OPC Safety Rule 8 (A-D). This certification must be a permanently affixed decal, plaque or other device.

Options 2 and 3 still require the inspector to assure himself that the boat is in compliance, but relieves him of the duty of exactly measuring the flotation foam volume due to difficulty of doing so in certain boat and cockpit designs.

9. Reinforced Cockpits:

A. All reinforced cockpits intended for use in OPC APBA sanctioned events shall meet the following criteria:

- 1). Cockpits constructed as of January 1, 2005 for the following classes - Formula 150, Super Sport, SST 120, SST-200, GT-1, Formula 1 and Mod U classes shall meet the 3000 Newton test.
- 2). Cockpits constructed as of January 1, 2005 thru December 31, 2015 for the following classes - Sport C, SST-45 and SST-60 - shall meet the 2000 Newton test or better. Cockpits constructed as of January 1, 2016 for the following classes Sport C, SST-45 and SST-60 classes shall meet the 3000 Newton test.

B. Manufacturers will submit their name or company name with a completed "OPC Reinforced Cockpit Questionnaire" and laminate samples for testing. The Reinforced cockpit Questionnaire is available from the "Resource" section on the APBA web site in the OPC Rule Book category. The lamination samples as described in the Questionnaire will be sent to the listed Testing Facility.

C. After review of the completed cockpit questionnaire and successful test results, the OPC Safety Committee chairperson will inform APBA Headquarters and the OPC category chairperson, and the manufacturer will receive an acknowledgement of registration.

FIGURE AA

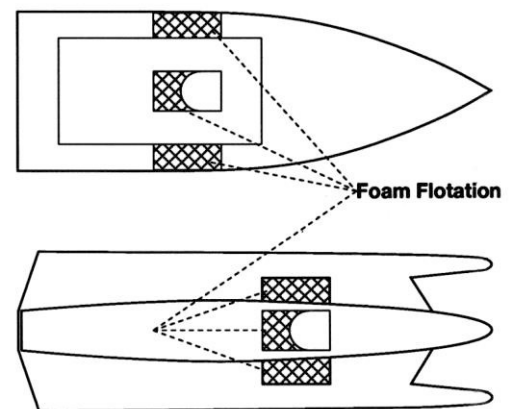

- D. The identification label must be positioned in such a manner as to be in plain sight during a safety inspection, and at the bare minimum contain the manufacturer's name, Newton test rating and build date. No boat built with a reinforced cockpit manufactured after January 1, 2005 will be allowed to compete without its label as described.
- E. All competitors driving and all passengers in an approved reinforced cockpit boat shall be required to utilize a restraint system consisting of a minimum 5-point mounting design. The restraint system shall consist of not less than two lap, two shoulder and two crotch straps, hooked together in a central release system. This release mechanism must remain released/open once it is activated and until it is reset. All belts shall be at least two (2) inches wide, entirely constructed of polyester material, SFI 16.1 certified and either replaced or recertified within three years after the date of manufacture as indicated on the SFI tag. The conformance label is a punch out patch. One patch shall be sewn onto the left strap of the lap belt assembly, one onto the left strap of the shoulder harness assembly and one onto the anti-submarine strap. The patch must have a manufacturer's built date with the month and year of manufacture punched out and easily identified or an expiration date. Belts with a manufacturer's expiration date must be replaced upon the manufacturer's expiration date. Belt systems must be mounted following manufacturer's recommendations (see illustrations). A list of manufacturers whose belts meet these criteria can be found on [www.apba.org](http://www.apba.org).
- F. For all reinforced cockpits using a full coverage canopy, the following shall apply:
- 1) Must provide airflow ventilation. It is recommended that the openings used in the ventilation system cut as little of the laminate around the driver area as possible. The driver area is defined as within 2 feet in all directions of the head and torso of the restrained occupant.
  - 2) Canopy is to have both internal and external release capability. It is highly recommended that the release system be constructed of materials that will resist corrosion from exposure to water and UV radiation.
  - 3) The laminate portion of the canopy (see Fig. D) must be constructed from the same lay-up schedule as the reinforced cockpit submitted for approval. It is recommended that the windscreen shall be constructed using a minimum wall thickness of 3/16" (0.187), of a shatterproof material. (The use of polycarbonate material "Lexan" or equivalent is recommended.)
- G. All attached hinges must have an easily removable stainless steel hinge pin utilizing a pull ring a minimum of 3/4 inch in diameter and accessible from outside the cockpit.
- H. All openings, access holes etc. cut through the laminate must utilize, or be accomplished with full circle holes, rectangular openings with 1-1/2" minimum corner radii or slots with full radius configured ends. It is recommended that all cut openings be back-routed 1/4" inch minimum and filled with epoxy material.
- I. Reinforced cockpit standards for Outboard Performance Craft:
- 1) It is suggested that an appropriate epoxy system be used.
  - 2) Minimum 2" clearance above driver's helmet is required; minimum 4" clearance is recommended. It is strongly recommended that all reinforced cockpit hulls be safety inspected each race day with an emphasis on minimum (2") helmet clearance.
  - 3) Minimum 1/2" (9 lb.) Ethofoam support behind driver's helmet is suggested to prevent helmet slapping rear of cockpit. It is recommended that head surround padding shall comply with SFI 45.1. Foam padding that will touch the helmet should be covered with Teflon tape (3M or equivalent) to reduce friction.
  - 4) No sharp protrusions anywhere inside or around entryway of capsule.
  - 5) Energy absorbing foam padding to be strategically placed inside capsule (in areas where knees, hands, etc. might impact).
  - 6) For recommended placement of seat belts and shoulder harnesses to be used in a reinforced cockpit, see Figures B and C.
  - 7) All harness attachment points should be secured as suggested in Figures B and C.
  - 8) A removable "spring loaded" steering wheel is required.
  - 9) Left and right rear view mirrors are required for all approved reinforced cockpit boats. It is recommended the mirrors be mounted to the capsule.
  - 10) The top of the front of the capsule should be a minimum of 4" below eye level. For forward visibility a windscreen may be incorporated in the opening of the reinforced structure such that the lowest edge of the opening is not more than 7" below eye level and must provide a minimum of 2" below eye level.
  - 11) To assist rescue crews, capsule boats must have either the entire capsule bottom, or materials covering the bottom, of the capsule labeled in the center with their assigned racing number. The number will be black on a white background that is approximately elliptical or rectangular in shape. The reverse of the preceding is also acceptable. Other strong contrasting combinations that are easily read are acceptable. Block characters shall be used and a minimum of 12" high and a stroke of 2" whenever possible.
- J. All cockpits must include coverage of over 50% of the driver's helmet (with the head in the furthest aft position, against the bulkhead) both above and on the sides.
- K. The following OPC classes are required to have a driver restraint/reinforced cockpit: SST 45, SST 60, SST 120, SST 200, F150, Formula 1, GT-1 and Mod U. Refer to section I (4).-Super Sport must use either a driver restraint/reinforced cockpit or a roll cage with driver restraint.
- 1) All Sport C boats are required to have reinforced cockpit sidewalls equal in height to the top of the driver's ear and extending forward of the driver's ear 10". (See Figures D and E.)
  - 2) Super Sport may use a "roll cage" with driver restraint instead of a reinforced cockpit. The "roll cage" must be constructed

so as to protect from frontal, side, rear, and top impact. It is recommended it should be constructed of chromoly, mild steel, or aluminum of sufficient gauge to withstand expected impact. All joints must be welded. The "cage" must be attached in such a manner to prevent it from being dislodged in the case of an impact. It may be bolted in. Bolts must be backed with a minimum of a 4 inch diameter round or 4 x 4" square washer having radiused edges. The washer must be a minimum of 3/16" aluminum or 1/8" steel. All other safety measures applicable to reinforced cockpit boats

- L. All boats are required to have a backboard (bulkhead behind seat) of reinforced material equaling the side in height. The reinforcement extends past the driver's compartment area and conforms to the normal sides of the boat.
- M. Boats equipped with reinforced cockpits/capsules, that have head protection over the head of the driver, must use a driver restraint system.
- N. All boats are required to have an electrical shut-off switch that will disable the engine located on the port (left) side of the boat (recommended outside of the steering wheel area).
- O. Boats without driver restraint systems require an electrical tether switch that attaches to the driver and will disable the engine if the driver leaves the seated position. All boats with a driver restraint system require a rollover switch which will disable the engine when inverted.
- P. All classes with reinforced capsules/cockpits must have a form-fitted seat with lumbar support. A custom fit foam-beaded seat is strongly recommended. The purpose of a seat: to work with restraint belts connecting driver's body securely to the cockpit, thus creating minimal movement between the cockpit and the body, spreading the impact load over the body, thereby reducing the chance of local loading and injury.

**10. Rescue Boats**

- A. Two (2) designated rescue boats capable of carrying one or more accident victims in a supine position shall be present and the craft shall be staffed and ready for use at all times when racing boats are under power. A patrol boat, properly staffed and equipped, may be used as a rescue boat.

**11. OPC APPROVED SAFETY COCKPIT TRAINING:** Upon request of the Referee, drivers of reinforced cockpit boats are required to show written documentation of having completed supervised underwater cockpit escape training per the current criteria. Such written documentation shall be signed and dated by an APBA Referee or other APBA official having reviewed the training. A current APBA racing membership card showing training to be current shall also be considered documentation. When escape training is completed prior to October 1, training documentation shall be valid for the racing season in which the training was taken and also for the following racing season ending October 31. When training is completed during October, training documentation shall be valid for the racing season in which the training was taken and also the following two (2) racing seasons ending October 31. To avoid expiration, it is recommended that training be done annually. Blank certificates will be available to approved training teams from the OPC chairman. Both the individuals issuing the certificates, and the participating dive teams, must be approved by the OPC Chairman. All training sessions must adhere to the approved test procedure as outlined in General Safety Rule 4, APBA APPROVED CAPSULE TRAINING CRITERIA.

12. It is recommended that all boat fuel tanks have a check valve on the vent or other device to prevent fuel loss in case of an accident. Overboard venting of the fuel tank is recommended.

13. All race boats of the catamaran type that are designed to have, or that have been modified to include, a spherical bulkhead at the termination of the bow end of the sponson, do not require deformable picklefork tips. Boats designed and constructed to include optional picklefork tips must conform to the following:

- A. The termination of the main body of the forward end of the sponson must end in a minimum of 100 cm<sup>2</sup> (16in<sup>2</sup>). The forward bulkhead shall be composed of a minimum of 3/4 in. thick plywood or equivalent material. This bulkhead must be an integral part of the main structure of the sponson. (Note: the purpose of the bulkhead is to cap the ends of the stringers; see Figure F.) The bulkhead must also have an additional rounded area or cap (spherical radius of at least 2.5 inches for Sport C, SST 45 and SST 60. All larger boats require a spherical radius of 4.0 inches). See Figure F.
- B. Optional picklefork tip may slide over the sponson as shown in Figure F.
- C. Picklefork tip shall have a front-end minimum horizontal radius of 1-3/8 inches.
- D. Picklefork tip shall have a front-end minimum spherical radius of one inch (see Figure F).
- E. A maximum of 3 in<sup>3</sup> of flotation foam is allowable in the tip of the optional picklefork. Compliance to the above rules shall be demonstrated by the use of a 1-inch hole to allow inspection of the spherical bulkhead and the interior of the picklefork tip or by removal of the picklefork tip.

Suggested lay-up schedule of the optional picklefork tip:

- 1) Gelcoat mold
- 2) Apply 3/4 oz. Mat and 7 to 10 oz. glass cloth. Let harden.
- 3) Pull and trim to fit.
- 4) Average lay-up thickness shall not exceed 3/32 inches. Suggested construction of the spherical forward bulkhead:

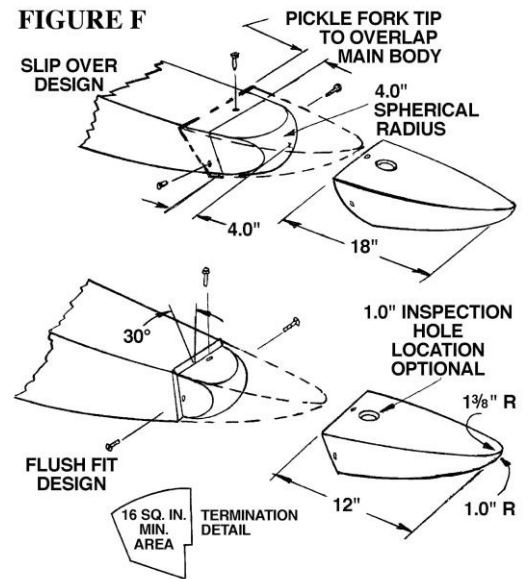

- 1) The spherical radius can be generated from foam material (maximum of 5 to 6 lbs. per cubic foot density)
  - 2) Shape foam to the approximate dimensions.
  - 3) Apply 3/4 oz. Mat and 7 to 10 oz. glass cloth overlapped onto the sponson or flat bulkhead.
  - 4) Spherical shape or cap may be built in place or produced separately and bonded to the forward bulkhead.
14. All OPC capsules manufactured after March 1, 1997 must stop the composite lay-up and install a composite lay-up load deflecting bulkhead at a point not to extend past the sponsons with the fiberglass tips off.
  15. No crew member may be on a boat while it is in the water under power unless an emergency requires assistance. Failure to comply with this rule will result with the driver earning two yellow cards.
  16. Additional Recommended Safety Measures:

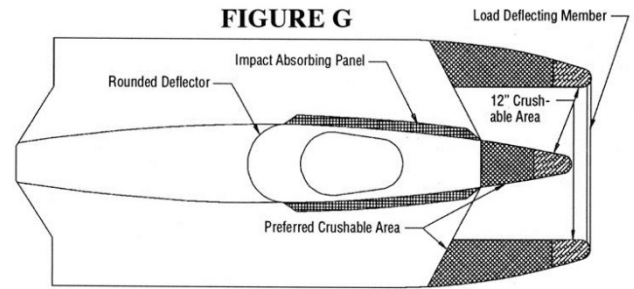

- A. A rounded deflector should be incorporated at the rear of the reinforced cockpit. The deflector should be manufactured from the same composite material as the reinforced cockpit, and should have a minimum thickness of 1/2". The deflector should cover the vertical area between the top of the cockpit and a horizontal line between the deck tops. The area in the boat interior below the deck surfaces may be left open. Solid foam should fill the volume between the deflector and the rear of the driver compartment. Additionally the reinforced cockpit structure should extend rearward from the driver compartment as far as possible.
- B. The sidewalls of the driver compartment should incorporate an impact-absorbing panel. It has been shown that thin metal layers in composite structures increase penetration resistance, especially to sharp objects. Such a panel with a foam impact-absorbing layer between it and the existing reinforced cockpit wall would offer additional protection. (See Fig. G.)

## **RULE 1 • GENERAL MANAGEMENT**

1. All administrative records of the OPC category must be turned over to the succeeding OPC Chairperson.
2. The OPC Commission must include the immediate past OPC Chairperson to insure continuity.
3. Any rule change or technical interpretations by the Motor Technical Committee not published in the annual rule book must be printed in Propeller magazine and will be effective thirty (30) days from the date of publication. This does not apply to emergency and safety rule changes.

## **RULE 2 • RACE ENTRIES**

1. Intentionally filing false or incorrect information on entry blanks shall be sufficient cause for suspension of owner and driver for one year from all racing as provided in the By-Laws of the Association. However, serial numbers are unnecessary in OPC and will not be cause for disqualification.
2. When no registration cutoff time is stated on the Official Race Announcement, drivers must report to the Race Committee or its authorized representatives at least one hour before the scheduled start of the race for the purpose of checking and verification of the information required and furnished on the entry blank.
3. The sponsor or Race Committee shall not limit the total number of entries for any event and must, if necessary, run qualification heats for any class in which more than the permissible number of entries are received.
4. A driver must be a current single event or annual OPC member to race in any OPC event.

## **RULE 3 • GENERAL RULES**

1. At any race at which the prize money is \$5,000.00 per class or more, the organizer shall be entitled to specify a dress code for drivers and crews entered, provided that all potential participants have been notified with sufficient time to enable them to comply.
2. The National office assigned number must take precedence in case of a number conflict.
3. Any driver who races a non-stock motor or hull or outfit which does not meet with technical specifications, as quoted in these rules, shall be disqualified. A third disqualification for use of non-stock equipment within a period of one (1) racing year will result in an automatic suspension for a period of one (1) year from the date the driver is notified by the OPC Chairman or until a fine of up to \$1000.00 is paid. Two (2) underweight disqualifications within six (6) months will result in a fine of up to \$1,000.00. A disqualification for being underweight is not considered a technical disqualification for considerations for suspensions. A fine of up to \$1,000.00 for technical and/or underweight violations is to be determined by a committee of three persons appointed by the OPC Chairman. Such fines are payable to the OPC Budget. The driver is to be suspended from the time he is notified of the fine by the OPC Chairman until the fine is paid.
4. A boat shall be disqualified which takes on fuel, supplies, equipment or articles or material of any description before crossing the finish line without receiving in advance the consent of the Race Committee. It will be permissible to change gearcases provided this is done under the control of the inspector and all gearcases involved in the change are declared legal by the Inspector. Refueling, adjustments and minor repairs are permitted. Minor repairs are: tightening of loose external nuts and bolts and the repair or replacement of propellers, steering system, throttle cable, shift cable, engine trim, engine tilt system, engine lift system, ignition system components, fuel lines, fuel filters, fuel pumps, carburetor jets, safety switch system, electric starting system components, and any other parts not covered by post-race inspection or technical rule requirements for that particular class. In the event of failure of the outboard motor or boat, a major repair or replacement may be made at the option of the Race Committee under the notification and control of the Motor Inspector, and all parts involved in the change are declared legal by the Inspector. The Race Committee, at its option, may handicap that competitor's starting position for the next heat/race. The outboard motor and/or boat to be used for major replacement cannot be competing in the same set of heats with

another driver. Powerheads may be changed under the following criteria only:

- A. A powerhead may be changed in between qualifying heats or before the final if the engine has been damaged and is not repairable on site. The driver may change powerheads without penalty of starting position upon inspector verification that the part in question is unrepairable on site.
  - B. A powerhead may be changed at any time, if time permits, provided the driver choosing to change the powerhead will receive a penalty of the least advantageous starting position.
  - C. A powerhead may be changed if the powerhead has been found to not comply with the technical rules for the class and the driver will receive a penalty of the least advantageous starting position.
5. Motor Fuel: Only motor fuel consisting of, or compounded of, standard pump and racing gasoline, shall be used. Petroleum-based and/or synthetic oils may be added to the fuel. See General Safety Rule 27. At each regatta the inspector may purchase samples of local gasolines, mix it with TCW-3 oil at a ratio of 20 to 1 and test it according to OPC procedures. If the test fuel exceeds the OPC testing thresholds, the new thresholds will become the maximum limit of the day. The source and grade of gasoline must be announced when registration opens. Fuel testing equipment will be made available to all contestants at least two hours prior to racing. The "Fuel of the Day" rule is not applicable at straightaway or competition record races. A contestant appealing a fuel disqualification must bear the expense of the fuel analysis and handling.
6. No substitution of drivers will be allowed after the race begins or between heats, except for events longer than one (1) hour.
7. OPC Minimum Age Requirements:
- |                                       |    |
|---------------------------------------|----|
| Sportsman Class Mini GT, GT-PRO ..... | 12 |
| Sport C .....                         | 14 |
| SST 45 .....                          | 16 |
- If a driver completes the requirements listed below they would be eligible to compete at age 14 in the SST 45 class.
- A. Competes in the APBA Junior classes for a minimum of 2 years
  - B. Attends the SST 45 driving school for a minimum of 2 days.
  - C. The driving school approves the driver for completion.
  - D. Driver must abide by OPC safety rules concerning Rookies.
- |   |    |
|---|----|
| VP75 minimum age 15 with 1 year OPC racing, otherwise ..... | 16 |
| SST 60, Tri-Hull .....                                      | 16 |
| All others.....   | 18 |
8. All boats shall have adequate equipment so that they may be lifted in or out of the water for the purposes of weighing. Each boat shall have a lifting sling/bridle capable of lifting the boat by a single hook. Lifting slings/bridles shall be constructed from minimum 1/4" steel cable or minimum 1" nylon strap. Attachment to the boat/motor will be by clevis pin or snap hooks to permanent attachment points located within or on the boat/motor and designed for lifting or weighing purposes. No ropes, open hooks or loops around pickleforks will be allowed. This bridle may be removed during competition but must be present for post-race weigh-in.
9. No device, water pickup, or attachment that artificially assists the delivery of water toward the water inlets of the engine will be allowed. This forbids the use of any device extending beyond or below the rearmost planing surface of the hull for that purpose.
10. CLOTHING
- A. For safety as well as appearance, drivers are required to wear coveralls or some type of uniform or clothing. Long pants are required.
  - B. Crews are requested to wear some type of uniform (i.e: coveralls or pants and shirt combinations).
11. Race officials may use videotapes to assist decision-making, including starts and finishes, and appeals.
12. Classes may run separately or together at the discretion of the Race Committee, but must comply with General Racing Rule 21 in order to score national points. When combining classes, consideration should be given by the Race Committee, to prevent the running of classes with vastly differing speeds at the same time.
13. Subject to restrictions in these rules, the Race Committee shall have power to specify the location, length and shape of the course, the number of turning buoys, position of the starting line, etc.
14. Scales at races cannot be protested, but must be available for use at least two hours before the start of the first heat of each day's racing.
15. The OPC Racing Commission shall have the power to review any and all paperwork resulting from APBA OPC races and time trials and shall have the power to correct any errors after the event but no later than the close of OPC business at the Annual Meeting.
16. For Scoring Procedure Clarification, see the current APBA Scorer's Handbook, OPC Scoring Procedures section.
17. FLAGS
- a. All signal flags shall be a minimum of two feet by two feet.
  - b. Flag colors/signals are used to designate specific time or to give instructions to contestants.
  - c. BLACK: Course is closed, return to pits; do not leave pits.
  - d. RED: STOP! STOP! Be alert and watch for other signals. The discharge of red or orange smoke/aerial flares in conjunction with RED FLAGS is advised.
  - e. WHITE: Time between one-minute signal and start; Leader has started last lap.
  - f. GREEN: Time between five-minute and one-minute signal; while Race is underway except last lap. Race course is open.
  - g. YELLOW - CAUTION: Problems on race course, continue with caution and HOLD POSITION.
  - h. BLUE/WHITE - CAUTION: Problems on race course, continue with caution.

- i. BLUE/YELLOW - CAUTION: Problems on race course, continue with caution.
- j. CHECKERED: FINISH.

#### **RULE 4 • DRIVERS' MEETING**

1. The Referee must choose at least one driver's representative.
2. In case a driver cannot attend a Drivers' Meeting because of extenuating circumstances, it shall be the privilege of the Referee to permit the driver to be excused, have a private meeting and possibly be subject to a maximum penalty of \$100.00.
3. It will also be the duty of the Race Committee to inform drivers where to congregate upon completion of racing. The Race Committee shall also have a meeting for all patrol boat personnel.

#### **RULE 5 • SUPERVISION**

1. A group of Deputy Racing Commissioners shall be appointed to represent the Outboard Performance Craft locally, and to assist the members and member clubs in matters pertaining to Outboard Performance Craft whenever called on to do so, preside at record approval sanctions, and though they may be qualified to serve on Race Committees, if invited to do so, they shall not have any extraordinary powers to set aside the decisions of the Race Committee.
2. All rule changes shall be governed by the APBA By-Laws.
3. Technical Committees may be appointed to advise the OPC Racing Commission and Deputy Commissioners on all matters of a technical nature.
4. The following procedure shall be used to add capable individuals to the list of approved OPC inspectors:
  - A. The name of an individual wishing to become an OPC inspector shall be submitted to the OPC Chief Inspector.
  - B. The OPC Chief Inspector will then send the inspectors' test to the recommended person.
  - C. The candidate will return the test to the OPC Chief Inspector, and as soon as the test has been successfully passed, the OPC Chief Inspector will notify the Category Chairman.
  - D. The candidate then must successfully work at a race with an approved inspector. A recommendation from that inspector must be made in writing to the OPC Chief Inspector.
  - E. After the recommendation is received, the OPC Chief Inspector shall promptly notify APBA Headquarters with copies to the OPC Chairman and the cognizant Region Chairman. That candidate's name shall then be added to the list of approved OPC Inspectors.

#### **RULE 6 • STARTING OF RACE**

1. The Race Committee shall limit the number of boats starting the race to a number of boats which can safely run on the course at one time. In the event that more than the prescribed number are ready to run, the field shall be divided into qualification heats. There shall be considered as qualified for the final heat that number of boats in each qualification heat which is equal to the maximum allowable number divided by the number of qualification heats. If more than one boat has earned consideration for one vacancy in the final field, the following tie breaker(s) should be used:
  - If tied on position, then break tie with most number of laps completed.
  - If tied on number of laps, break tie with least elapsed time for his/her qualification heat(s).
  - No points accumulated in qualification heats shall carry over to the computation of the final results.
- A. In races of more than 5 laps, consisting of 1 heat only, where positions and National High Points are awarded, the scorer may have the option to record lap times for every boat every lap.
2. Modified LeMans, clock, poleboat or flag starts may be used.
  - A. Clock start:
    - 1) The official start shall be the exact instant when the hand of the starting clock indicates that the final minute has elapsed. The Referee and all other officials must use the clock rather than either flag or gun in determining disqualifications. A false start will be called if, in the opinion of the Referee, the Race Committee has failed to record the numbers of those boats that have crossed the starting line before the official start. If the Race Committee has acted in error, a restart shall be in order. In case of a failure to record the numbers, the lead boat shall be assessed a one-minute or one-lap penalty at the discretion of the referee, with the assistance of the Race Committee.
    - 2) Boats crossing the starting line during the last 45 seconds of the one-minute period before the race start shall be assessed a one-minute or one-lap penalty at the discretion of the referee, with the assistance of the Race Committee.
    - 3) All boats preparing to start must, after the one-minute gun, go fairly around the last turn buoy (of the last turn before the starting line) prior to approaching the starting line.
    - 4) The starting line shall be of sufficient length to permit all starters to start abreast without interference. Both ends of the starting line shall be plainly marked and the flagman shall be on the line clearly visible to all contestants. All competing boats must cross the starting line between the markers indicating the official starting line and the official stand.
  - B. LeMans start:
    - 1) When qualifying heats are not required, starting positions for the First Final Heat will be assigned by the Race Committee. It is recommended that this be done by random drawing of all boats in the class.
    - 2) The first place boat with equal number of laps completed and the least elapsed time, from the qualification heats, will be qualified. In the event that vacancies still occur, other boats will be taken from the qualification heats according to their positions of finish. In case of a tie, the qualified position shall be awarded in the following manner: (1) break tie with most number of laps completed. (2) If tied on number of laps, break tie with least elapsed time for his/her qualification heat(s).
    - 3) Starting positions for subsequent qualifying or final heats will be determined by the race committee.
    - 4) All boats entered in the heat to be run may be allowed one Parade or Hot Lap to warm up their engines.

- 5) In races of more than 5 laps a boat shall be allowed to start at any time, in a safe manner.
  - 6) Boats will line up in the order assigned them by the Race Committee at the designated starting area. Boats not ready to line up when required will be disqualified or placed in the least desirable starting position at the discretion of the Race Committee.
  - 7) A one-minute gun will be fired and a countdown will begin. At this time all engines must be dead and the boats in position for the start. Engines approved by OPC Technical Committee without electric starting systems may have their engines running in neutral. (See Super Sport rules.)
  - 8) With 20 seconds remaining in the minute, the starting flag will be raised. The flag must be positioned so that all drivers can see it. The flag may be dropped at any time within the remaining 20 seconds signaling the boats to start.
  - 9) The official start of the race is the exact instant when the start signal is made (flag dropped, etc.) The flag shall be considered dropped when the downward motion of the flagpole is initiated. Every boat lined up in a starting position on the starting dock when the flag drops will be considered a legal starter.
  - 10) Timing will begin when the first boat crosses the start line.
  - 11) Any boat starting early will be penalized. If the start is aborted, the penalty is 1 lap or move to the end of the dock, at the discretion of the Race Committee. If the flag drops to start the boats, there will be a 1-lap penalty.
  - 12) In the interest of safety, the Race Committee may make rules for individual race courses governing lane changes on starts. The rules and penalties must be announced at the Drivers' Meeting.
- C. When time trials are used to determine the lineup for qualifying heats the first heat will line up as follows: the fastest time will be pole position and the 2nd fastest time will be in start position # 2 and so forth. The second qualifying heat (if used) will line up as follows: Reverse of finish taken from the results of the first qualifying heat.

#### **RULE 7 • RESTART**

1. In the event a restart is caused by a driver, the following penalty will apply:
  - A. If a clock start is utilized, the driver must start at the far outside of the field or must start a minimum of five (5) seconds after the official start of the race.
  - B. If a LeMans start or poleboat start is utilized, the driver will line up at the end or whichever is the least advantageous starting position.
  - C. The driver may restart after medical release.
  - D. In heats of more than five laps, if the race is not restarted, and final results are taken from the last completed lap, the driver will receive a 2-lap penalty.
  - E. Only those boats that were legal contestants on the race course at the time the heat/race was stopped are eligible to run in the restart.
2. If a LeMans or poleboat start is utilized, starting positions for the restart will be determined by the order of position—not running order—each boat was in for the preceding completed lap, whenever deemed possible by the Race Committee.
  - A. If a race is stopped, any boat that goes on a trailer will be required to line up at the end, or whichever is the least advantageous starting position. Refueling, adjustments and minor repairs are permitted in the water. See Rule 3, General Rules paragraph 4.

#### **RULE 8 • FINISH**

1. After the lead boat finishes the specified distance, all other boats will be allowed to complete the specified lap on which they are engaged. In case two or more drivers have scored the same number of points, thus establishing a tie, the driver with the highest total number of laps accumulated will break the tie. If a tie still exists, the match will be awarded with the least time for the heats. If a tie still occurs, the points for the two positions of finish shall be totalled and each driver shall receive 1/2 the total.
2. In races of 5 laps or less, a boat, in order to be scored, must be running under its own power at the finish. In races of more than 5 laps a boat, in order to be scored, need not be running under its own power at the finish.
3. After crossing the finish line, a boat shall not interfere with any boat still in the race as to affect the time of such boat at the finish and, when course layout permits, shall move to the infield prior to passing the last buoy of the first turn after yielding to boats on the left and remain in the infield until signaled by a black flag.
4. Closed Course Timed Marathons: The order of finishing closed course timed marathons will primarily depend on maximum distance traveled in the designated duration of the marathon plus the time needed to complete the remaining fraction of the last lap of each specific boat.
5. Closed Course Distance Marathons: The winner of a closed course distance marathon is the first boat to complete the specified distance and is the only entry eligible for a record, except when the first place boat is subsequently disqualified in which case the second place boat is eligible for a record, etc. However, to be eligible for the record the boat must have traveled the total specified distance. After the lead boat finishes the specified distance, all other boats will be allowed to complete the specific lap on which they are engaged. The subsequent order of finish will be determined by the total distance traveled.
6. In the event a race must be terminated for safety considerations, it may be called a legal race if more than one-half the time or distance has been achieved.

#### **RULE 9 • OVERLAP**

1. An overlap is established only when two boats are on the same course, or approximately the same course, and the cockpit of the overtaking boat (if overtaking from the inside) is even with the cockpit of the overtaken boat. When overtaking from the outside, an overlap is established when the overtaking boat has passed the overtaken boat sufficiently to change lanes without contact. The following rules shall apply to an overlap:
  - A. The lead boat has the right of way until an overlap is established.



- B. A safe overlap is the responsibility of the overtaking boat.
  - C. Once an overlap is established, the overtaken boat must give the overtaking boat room to clear any course markers.
  - D. The overtaking boat cannot force an overlap after the lead boat has begun to alter course to negotiate a turn.
  - E. An overlap can occur from port or starboard.
2. Bearing away as defined in the General Racing Rules is defined as occurring from either port or starboard in OPC racing.

#### **RULE 10 • BUOYS-PENALTIES**

1. Contestants who fail to turn a buoy may return immediately and circle to the left for a left-turn buoy, or the right for a right-turn buoy, inside the course, and pass the missed buoy on the proper side, keeping clear of the balance of the field in so doing. If contestant fails to return, he shall be penalized one lap.
2. Any boat which fouls a buoy (except if forced into it because of an overlap violation); forces another boat to foul a buoy or other obstruction; or violates in any other way the rules governing right of way, shall be penalized one (1) lap. The Referee may, with or without a protest, before the awarding of prizes, penalize any boat which has committed a breach of these rules.
3. A buoy that has become fouled, or a float that has been attached for the purpose of finding the rope, shall not be considered a buoy. Any float less than 12" in size shall not be considered a buoy and contestants shall not be required to pass the float on the proper side.
4. It is recommended that a second buoy be attached to a float when possible.

#### **RULE 11 • SCORING POINTS**

1. Any given class scheduled twice on a one-day sanction cannot score High Points for both races. Only the first race of that sanctioned day shall be tabulated for High Points.
2. In heats of 5 laps or less, a driver will receive no credit for points in a heat if he withdraws from the course or fails to finish.
3. In case two or more drivers have scored the same number of points for the series, thus establishing a tie, the match shall be awarded to the one of the tied drivers in the following manner:
  - Break tie with most number of laps completed.
  - If tied on number of laps, break tie with least elapsed time for both of his/her qualification heat(s).
  - If a tie on time also occurs, and the number of laps are equal, the driver having the fastest heat shall be the winner.
  - If a tie still occurs, the points of all tied positions of finish shall be totaled and each driver shall receive an equal share of the points to be awarded.
  - If a Lemans start is used and a tie cannot be broken by the above method, disregard bullet #4 and use bullet #5. The order of finish will be determined by the starting position of the tied drivers.
4. Any boat and motor will be allowed to compete in any class in which it qualifies according to the rules of that class. The driver will receive points in the class in which he runs.
5. In the event there are qualifying matches, in order to determine starting position for a final event, the finish of each qualifying match shall be determined according to the table under General Racing Rule 21 • Scoring Points.
6. The starting position for the final event shall be determined by order of finish in the qualifying match. When two or more boats have finished in the same place, the starting order shall be determined by the boat with the least elapsed time. In the event the boats with the same order of finish in the matches have not completed an equal number of laps, the order of start shall be determined by the least elapsed time for the most equal number of laps completed by the boats with the same place of finish in their match.
7. National Headquarters will tabulate high points on a race basis with the following procedures:
  - A. High Points will be credited to the driver of the boat, as shown on the Official Summary Sheet, for the class entered and not to the owner of the boat, if different.
  - B. There must be at least three starters of the class in any heat of a regular (non-championship) race to receive National High Points. If the first heat had three starters, then any subsequent heat shall be cancelled only if no boats cross the starting line.
  - C. High points will be scored for the first through twentieth overall positions for all events.

- D. All OPC events other than Regional, North American, Divisional, World or National Championships, shall be scored for the purpose of high points competition as shown below under the column heading "Regular". Regional, North American, Divisional, World and National Championships shall be scored for high points as shown under the respective column headings. High points shall be based on overall placement in the race.

Overall Finish	Regular	Regional Championship	North American,, Divisional, Worlds (using standard heat format)	National & World Championships (using 3 best of 4 heat format)
First .....	400 .....	600 .....	800 .....	1,200
Second .....	300 .....	450 .....	600 .....	900
Third .....	225 .....	338 .....	450 .....	675
Fourth .....	169 .....	253 .....	338 .....	506
Fifth .....	127 .....	190 .....	253 .....	380
Sixth .....	95 .....	142 .....	190 .....	285
Seventh .....	71 .....	107 .....	142 .....	214
Eighth .....	53 .....	80 .....	107 .....	160
Ninth .....	40 .....	60 .....	80 .....	120
Tenth .....	30 .....	45 .....	60 .....	90
Eleventh .....	23 .....	34 .....	45 .....	68
Twelfth .....	17 .....	25 .....	34 .....	51
Thirteenth .....	13 .....	19 .....	25 .....	38
Fourteenth .....	10 .....	14 .....	19 .....	29
Fifteenth .....	7 .....	11 .....	14 .....	21
Sixteenth .....	5 .....	8 .....	11 .....	16
Seventeenth .....	4 .....	6 .....	8 .....	12
Eighteenth .....	3 .....	5 .....	6 .....	9
Nineteenth .....	2 .....	3 .....	5 .....	7
Twentieth .....	2 .....	3 .....	3 .....	5
Minimum Number of Starters .....	3 .....	4 .....	5 .....	5

- E. For combined classes, the Race Committee shall be responsible for submitting a separate summary sheet for each class combined, showing the finishing positions of each driver for each class.
- F. Each driver's name on the summary sheet must be followed by the driver's APBA card number. In the case of one-day memberships, it must be stated "one-day".
- G. US-1 and US-2 awards shall be determined on a "best-of-ten" race basis (the 10 races with the highest number of points scored). This should include Regional, Divisional, and National Championship high points. A tie would be broken by going to the 11th race or further as needed.
- H. A driver must have competed in at least five sanctioned OPC regattas in a specific class during the current racing year to receive US-1 or US-2 in that specific class.
- I. A driver receiving US-1 may display the shield and be allowed to use the #1 in that class for the next year's racing season. In combined classes the decision on who gets to use the number will be determined by draw. A driver receiving US-2 may only display the shield and may not use this as his racing number.
8. All scoring penalties shall be assessed after the completion of the heat.

**RULE 12 • EVENTS**

1. Events may be designated as timed events with a specified time for the length of the event.
2. Distance events may be a specified number of laps or a specified distance in miles. An OPC Marathon shall be defined as a race consisting of one or two heats of not less than 20 minutes, or a pit stop, or a race on a course of not less than 5 miles per lap.
3. In timed and distance events, a boat may accept a tow to the pit area and later return to the race if so specified in the rules of the event and brought to the attention of the drivers at the driver's meeting.
4. No claims for records will be entertained in Point-to-Point events.
5. There must be at least five (5) starting boats to constitute a point-to-point event.
6. Any driver and/or assistant driver who is a registered entry in a point-to-point marathon must report his failure to start or complete that marathon. Any driver and/or assistant driver failing to do so will be automatically suspended for a period of six (6) months from the date of the infraction. Sponsors must supply the drivers with an emergency telephone number before the start of the regatta. The Referee may review extenuating circumstances under which the driver failed to report.

**RULE 13 • STRAIGHTAWAY TRIALS**

1. Participants will be limited to full annual racing members of the APBA.
2. Referees for time trials must be chosen and approved by the OPC Racing Commission from the approved list.
3. In order to qualify for kilometer and 1/4 mile records, a driver must have participated in a sanctioned APBA OPC event, in that class, in the preceding 12 months.

**RULE 14 • CHAMPIONSHIPS**

1. During each racing year a championship regatta shall be held for annual members of the American Power Boat Association

only, provided that satisfactory arrangements can be made for such championship races. They are as follows:

- A. At Regional and Divisional Championship races, drivers from other Regions and Divisions are allowed to participate and win the Championship.
  - B. There shall be one National Championship for all OPC National classes.
  - C. One World Championship may be scheduled for each class, subject to approval by the OPC Commission.
  - D. Any APBA class that is run in an annual national series of races may compete for the APBA/UIM World Championship for that class in the series of races using the 9, 6, 4, 3, 2, 1 point scale. The series would then be considered the World Championship Series and the driver earning the most points in the series would be awarded the APBA/UIM World Championship for that year in that class. The series would be awarded the title on a bid basis.
  - E. The OPC Chairperson shall check all sanctions for OPC races scheduled on the same date as the OPC Nationals for conflict. No sanction applications for the same date as a National Championship shall be approved for that class. Clubs requesting sanction applications for the same date as a National Championship class may petition the OPC Commission 90 days in advance of the event to grant an exemption for the above. Regional, Divisional, North American and World Championship events will not be granted exemptions.
  - F. It is incumbent on the OPC Commission to award the UIM World Championships at least 18 months in advance of the scheduled events. This would customarily be done at the APBA Annual Meeting. If possible, all National, Divisional and North American Championships shall be awarded at the Annual Meeting preceding the event. If an all-inclusive National Championship event, including all National Classes, has not been awarded by the Annual Meeting, clubs/producers may submit a bid for National Championships for selected classes. The OPC commission has authority to review, then accept or reject the bids as deemed appropriate. All Regional Championships shall submit a bid to the Region Chairman.
  - G. Two championship events (ie: Regionals, Divisionals, Worlds, Nationals and North American Championships) cannot be sanctioned at the same event within five consecutive days. I.E: only one bonus championship set of points will be allowed; however, if the championship is on one day, regular points can be awarded for events run the other day, as per the APBA rule book.
- 2. To be eligible for Regional bonus points and titles there must be at least four (4) bona fide starters. To be eligible for National, Divisional, North American and World Championship bonus points and titles there must be at least five (5) bona fide starters. If there are fewer starters than required, only regular points will be awarded and no championship will be awarded. If qualifying heats are run, they will establish the number of bona fide starters.
  - 3. If a Divisional and/or National title is not awarded at the event scheduled due to lack of entries or legal finishers, said title will not be rescheduled and no title will be awarded for that racing year.
  - 4. The final field for the National Championship shall consist of the first place boat with equal number of laps completed and the least elapsed time, from the qualifying heats. Other boats will be taken from the qualification heats, according to their positions of finish. In case of a tie, the qualified position shall be awarded in the following manner:
    - 1) Break tie with most number of laps completed.
    - 2) If tied on number of laps, break tie with least elapsed time for both of his/her qualification heat(s).
  - 5. If extenuating circumstances prevent the final event from taking place, the championships will be decided on the results of tabulations from the qualifying heats.
  - 6. For bids and other aspects of World Championships, the UIM Rule Book shall apply, as well as any additional administrative requirements specified by APBA National Headquarters. The UIM Rule Book is available, for a fee, from APBA National Headquarters.
  - 7. In the event that a World or National Championship becomes available due to the cancellation of awarded championship, the OPC Chairman will advise all OPC Commissioners, who shall notify OPC clubs or producers. The bid process shall reopen and bids for the Championship shall be accepted up to 15 days after the written notification.
  - 8. All National Championship bids submitted to the OPC Commission for consideration shall include a deposit in the amount of \$1,000. All World Championship and Divisional bids submitted shall include a deposit of \$500.00 and \$250.00 respectively. The deposit shall be non-refundable if the bid is accepted. The deposit will be returned to the sponsor at the start of his championship race. Cancellation of the Championship shall cause the deposit to be forfeited to the OPC Awards fund. 9. All bids for a championship event must supply a proposed format of events to the OPC Chairman for that race.

#### **RULE 15 • HALL OF CHAMPIONS CRITERIA**

In order to qualify for the APBA OPC Hall of Champions a driver must compete at the designated National championship, providing a National Championship is held for that year. A minimum of 8 bona fide starters are required to receive National Champion and World Champion points. Points would be awarded, in one class, for the following accomplishments during the racing year. Once qualified, the member will be awarded points for the further accomplishments in that year according to the following table.

- a) National Champion.....3 points
- b) World Champion .....3 points
- c) National High Point Champion .....3 points
- d) Approved Major Series Champion .....3 points
- e) Approved Minor Series Champion ..... 1 point
- f) Divisional Championship, each ..... 1 point
- g) North American Champion .....2 points
- h) Record broken in an existing class, each.....2 points (with a maximum of 4 points)
- i) Regional Championship, each..... 1/2 point

j) US-2, Second place in High Point Championship ..... 1/2 point

Note: a driver can only receive points for ONE Series, Major or Minor.

2. A driver may only count a total of 6 points from the National Championship, World Championship and/or Series Championship
3. Up to ten (10) points may be deducted for anything detrimental to our sport, such as proven illegal or unlawful activities, lawsuits involving APBA or APBA members, blatant unsportsmanlike conduct, etc. Final decisions as to this matter will be up to the APBA/OPC Hall of Champions Selection committee as appointed by the OPC Chairperson.
4. In the event of a technical disqualification, 2 points will be deducted from the point total (prior to the class multiplier) for each violation.
5. In order to determine final point totals in a fair manner for all classes, the following formula will be used. If point totals are awarded for competition in one class, the total number of points is multiplied by the number of wet boats in that class for the given year. The total number of wet boats multiple cannot exceed 25.
6. In case of a tie on points, the following are tie breakers (in order listed):
  - a) The driver placing in the highest position at the National Championships
  - b) If a tie still exists, the driver with the highest points total in one class, "best of ten" race basis.
7. No more than one inductee from a class will be allowed into the Hall of Champions in a racing year.
8. Once approved, no other changes to the criteria can be made during the racing year.
9. No OPC class may have a permanent inductee yearly status.

### **RULE 16 • MAJOR AND MINOR SERIES**

1. Any club organizing an annual Major or Minor series may petition the OPC Commission for permission to race under special racing rules. This petition, along with the entire special rules proposal, must be submitted to the OPC Chairman two weeks before the annual convention each year. All Major or Minor series must be approved by the OPC Commission at the National APBA meeting. Rules for series must be available for public viewing at the National APBA meeting. No change of said rules is permitted without Commission notification. Upon approval, the special rules must be included in each race circular or be referenced, in the race circular, with a contact from which any member can obtain a copy prior to any race. If the class racing and technical rules are altered in a given class, that class may not claim national high point credit at those races. The sanction fees are to be established by APBA National Headquarters. Both Major and Minor Series may accumulate points to determine their class champions.

SERIES MINIMUMS	Major Series	Minor Series
Number of races per season	5	4
Number of APBA regions raced in	two	
Purse (Prize money plus tow money) per event	\$4,000.00	\$1,000.00
Average participants per class per race	10	7

- A. Any series that falls below the average boat count for one year, will go on probation.
- B. A Major Series that falls below minimum boat count for two years will lose its major series status but may still be eligible for Minor Series status.
- C. If a Minor Series falls below the minimum boat count for two years, it will lose its series status with the category.
- D. Any series must comply with A, B and C above to be eligible for Hall of Champions awards in that year.
- E. No more than two major series will be approved for any single APBA class. There shall be no limit on the number of minor series allowed.

### **RULE 17 • PROTESTS AND APPEALS**

1. All penalties must be assigned by the conclusion of inspection. It shall be the responsibility of the driver if he/she leaves the race site before the race completion (completion of race is one hour after the completion of inspection), to provide contact information for the referee to communicate with him/her. This information should be given to the Chief Referee and the Chief Scorer.
2. Drivers shall have the right to protest any violation of the rules arising from sanctioned regattas affecting their particular class. The protest must be filed in writing with the referee not later than one hour after the finish of the inspection of the class in question or not later than one (1) hour after the finish of the last heat of racing on the day's schedule, whichever comes later. The complainant must post a minimum fee of \$100 or additional fees, in accordance with the category rules. A written notification of the protest must be delivered to the protested driver. The written protest must state the alleged infraction. The subsequent inspection will be conducted by the inspector only as to the point of ascertaining the legality or illegality of the protest. The only persons to be present are the protested driver, his mechanic or representative, the inspector(s) and the chief referee. The decision of the inspector and chief referee shall be conveyed to the parties involved only.
3. The Inspector serving on the Race Committee shall be the sole arbiter of boat and motor protests, except in the case of questionable condition or application of parts or approval of parts and/or motor models, which must be referred to the Racing Commission. In any case, the usual \$100.00 fee, plus \$50.00 per cylinder for a powerhead protest, shall be collected from the party protesting another contestant. If the boat or motor is found to be in compliance, the protesting party's protest fee shall be awarded to the protestee. The owner of a boat or motor so protested shall present his boat or motor for inspection immediately after the race, or when required to by the Referee. In the case of a motor protest, the Inspector shall when necessary instruct the owner or driver to dismantle the motor completely. The Inspector may impound certain parts to determine their compliance with these rules. In case of a boat protest, the Inspector shall measure, weigh and request the driver or owner to remove certain parts such that the Inspector may ascertain if the boat complies with these rules or if water was used in compiling class weight. Any expenses required to carry out the terms of this rule shall be borne in full by the loser.

4. Any disqualification involving a motor or boat rules may, at the competitor's discretion, be appealed to the OPC Commission. An appeal fee of \$250.00 will be charged for all local, series and Regional Championships. The appeal fee for World, North American, Record runs and National Championships will be \$500.00. If the appeal is upheld, the fee, less shipping and handling, will be returned.

Such Appeal is only for the verification of the measurement of the specification (second measurement beyond the inspector). Under no circumstance shall the referee be required to send a part larger than the largest part of the motor on the boat involved in the disqualification. The Motor Technical Committee has thirty (30) days after receiving the parts to report findings to the OPC Commission for a vote to approve or deny the appeal, or to extend the time for the MTC to report its findings.

5. In case of an appeal of the technical inspection, the entire engine technical inspection process must be completed.

## **RULE 18 • RECORDS**

1. Criteria for official APBA records are given in the General Racing Rules, The following is a brief compilation of the most applicable portions of the general rule and specific additions permissible in OPC competition events.

### **A. Course lap distances**

- 1) 3/4-mile on a specified course approved by the APBA Chief Surveyor and available from National Headquarters
- 2) 1 mile
- 3) 1-1/4 mile
- 4) 1-2/3 mile

### **B. Heat distances**

- 1) 3 miles on a course of 3/4-mile.
- 2) 5 miles on courses of 1 mile, 1-1/4 mile or 1-2/3 mile.

a) A 5-mile, 5-lap record shall not be certified until it exceeds the current 3 mile, 3 lap record in each case.

- C. Timed marathon records shall be run on any of the course sizes approved for OPC records for periods of one-half hour or one hour. Timing for this format event shall begin when the first legal boat crosses the start/finish line and will terminate when the boat crosses the start/finish after the advertised time has elapsed.

- D. Records shall be retired and new records established for classes that "change significantly"; said "significant change" to be determined by current OPC Commission of record.

## **RULE 19 • NEW CLASSES**

1. The OPC Commission approves the class, and forwards to New Class Committee (NCC).
2. If class is approved by both Commission and the NCC, the class will be placed on probation for one year as a Probationary National Class.
3. After one year, said Probationary National Class must have six registered drivers who have competed for the year. Class must also have had fields of six (6) boats or more in two different Regions, in order to attain full National Class status the following year.
4. If the proposed class does not pass the NCC, or fails to meet the criteria set forth in 3., said class can run as a Divisional Class, providing the safety rules and requirements have been approved by the National Safety Committee.
5. During the probationary period, National High Points will be awarded; however, no Hall of Champions, records or National Championships would be awarded until the class attains full National Class status.

## **RULE 20 • CLASSES**

1. OPC Classes are grouped into categories by engine types: Stock, Super Stock, Formula and Altered. OPC offers National classes and Divisional (Sportsman) classes. National High Points will be awarded to National classes only. Divisional classes will not receive National High Points. In the event that a National class's season boat count of active wet boats falls to six or below, said class will be put on notice, and given two years to bring boat count up. If the boat count remains below seven, said class will be demoted to Divisional (Sportsman) Class status

### **A. NATIONAL CLASSES:**

<u>Stock Classes</u>	<u>Super Stock Classes</u>	<u>Altered Classes</u>	<u>Formula Classes</u>	<u>National Limited Classes</u>
Sport C	SST 45	Mod U	Formula 150	Formula 1
	SST 60	GT-1		Formula Tri-Hull
	SST 120			
	SST 200			

### **2. SPORT Agreement for F1 and Formula Tri Hull ... National Limited Classes.**

- a. F1 and Formula Tri-Hull are subject to all APBA general safety rules (GSR).
- b. SPORT has complete control of all racing and technical rules for F1 and Formula Tri-Hull. The F1 and Formula Tri-Hull racing and technical rules shall be posted on the APBA website and any other websites designated by SPORT. SPORT is the sole and final decision-maker regarding eligibility, legality, and appeals at all SPORT events for F1 and Formula Tri-hull only. APBA has no authority to overrule any decision made by SPORT regarding these two (2) classes.
- c. F1 and Formula Tri-Hull shall be eligible for APBA national high point championships and national championships held at annual national championship regattas. F1 and Formula Tri-Hull are not eligible for Hall of Champions through the OPC Category.
- d. SPORT may run F1 and Formula Tri-Hull at all races that their club conducts. Other APBA clubs may run F1 and/or Formula Tri-Hull with written permission from SPORT.

e. In addition to F1 and Formula Tri-Hull, SPORT may run other APBA classes at their events. When classes other than F1 and/or Formula Tri-Hull are run at SPORT events, these classes will be run in compliance with all APBA rules.

**B. DIVISIONAL (SPORTSMAN) CLASSES:**

Mini GT, GT PRO, Sport C Marathon, Super Sport and VP 75

**2. STOCK CLASSES: SPORT C**

**A. SPORT C TECHNICAL STANDARDS**

<u>Max. Total Cu. In. Displacement</u>	<u>Min. Boat Length</u>	<u>Min. Boat Weight</u>
35.00 CI	8' (14' Max.)	675 Lbs.

Sport C Boat Standards (see also Rule 21)

- 1) Trim tabs or afterplanes are allowed, and may be adjustable while the boat is underway; however, hydrofoils shall not be permitted.
- 2) Power trim and/or adjustable spoilers shall be allowed in Sport classes.
- 3) Boat must be of vee, flatbottom, modified vee, or tunnel design; no hydros. The boat must be at least 48.0 inches wide.
- 4) Driver must be seated in a seat.
- 5) Running surfaces may be altered.
- 6) Factory or non-factory turn fins or skegs are allowed.
- 7) Transom adapters for raising, lowering or extending the engine will be allowed, but must be fixed while underway.

**Sport C Motor Standards** (see also Rule 23, 25, 26)

- 1) Super Stock and Altered engines are not eligible in OPC Sport classes.
- 2) Engine cowling must be in place during race. If cowling or engine is repainted it must be repainted to original colors to retain product identification.
- 3) Tiller arms may be removed.
- 4) Any reed material will be acceptable.
- 5) Gearcases' outside surfaces may be contoured, but must meet production specifications.
- 6) Solid or pinned motor mounts allowed.
- 7) The skeg may be sharpened to a 1/32 radius and the wear plate removed.
- 8) Sport C engines may have a substitution of a maximum of 2 sleeves of any manufacturer with original porting specifications and the same material will be allowed for the repair of damaged cylinders.
- 9) Grinding is permitted to match block casting to the ports/liner. No grinding is permitted beyond 5/8 inch past the liner into the casting of the block. All OPC Technical Specifications must be maintained.
- 10) Sport C class is to use one 12-volt "nominal" battery only.

**3. SUPER STOCK CLASSES: SST 45, SST 60, SST 120, and SST 200.**

**A. SST 45 TECHNICAL STANDARDS**

<u>Max. Total Cu. In. Displacement</u>	<u>Min. Boat Length</u>	<u>Min. Boat Weight</u>
44.9 (740cc)	12'	700 Lbs.

**SST 45 Boat Standards** (see also Rule 21)

- 1) Any design of boat including bottom, deck, cockpit openings and seating arrangements is permissible so far as boat meets minimum length.
- 2) Power trim and/or adjustable spoilers shall be allowed in Super Stock classes, except up/down lift adjustable while boat is underway for the SST 45 class.
- 3) All cowling and engine graphics and colors shall be essentially the same as OEM, with updating to later models allowed only as a complete OEM design.
- 4) SST 45 drivers must be seated in a seat.

**SST 45 Motor Standards** (see also Rule 23, 25, 26)

- 1) SST 45 class to use one 12-volt (nominal) battery only.
- 2) SST 45 class gearcases may have their outside surfaces refinished, but must meet the requirements of OPC Engine Specification sheets and the original design. The outside surfaces of the gearcases may be either painted or unpainted. If they are painted, the color of the paint must be the same as the original factory motor color. If the gearcases are unpainted, any surface finished is acceptable.
- 3) SST 45 class may use alternate plastic reeds - OMC part number 568427.
- 4) SST 45 class shall use only one propeller of three blades or less.
- 5) SST 45 engines may have a substitution of a maximum of 2 sleeves of any manufacturer with original porting specifications and the same material will be allowed for repair of damaged cylinders.

**B. SST 60 TECHNICAL STANDARDS**

<u>Max. Total Cu. In. Displacement</u>	<u>Min. Boat Length</u>	<u>Min. Boat Weight</u>
56.1 (920cc)	14'	825 Lbs.

**SST 60 Boat Standards** (see also Rule 21)

- 1) Any boat design including bottom, deck, cockpit openings and seating arrangements is permissible so long as boat meets minimum length.
- 2) Power trim and/or adjustable spoilers shall be allowed in SST 60 classes.
- 3) SST 60 classes can change engine wiring to allow 24-volt starting system.

**SST 60 Motor Standards** (see also Rule 23, 25, 26)

- 1) All cowling and engine graphics and colors shall be essentially the same as OEM, with updating to later models allowed only as a complete OEM design.
- 2) The SST 60 class gear cases may have their outside surfaces re-finished; however, they must meet the requirements of OPC Engine Specification sheets and the original design. The outside surfaces of the gearcases may be either painted or unpainted. If they are painted, the color of the paint must be the same as the original factory motor color. If the gearcases are unpainted, any surface finished is acceptable.
- 3) SST 60 class may use alternate plastic reeds - OMC part number 568428.
- 4) SST 60 engines may have substitution of a maximum of 3 sleeves of any manufacture with original porting specifications and the same material for repair of damaged cylinders.
- 5) Glue line may be removed on "Boost Port" only. (The Motor Technical Committee will establish the specifications to be printed on the inspection sheet.)

**C. SST 120 TECHNICAL STANDARDS**

<u>Max. Total Cu. In. Displacement</u>	<u>Min. Boat Length</u>	<u>Min. Boat Weight</u>
122.0 (2.0L)	16'	1,100 Lbs.

**SST 120 Boat Standards** (see also Rule 21)

- 1) Any design of boat including bottom, deck, cockpit openings and seating arrangements is permissible so far as boat meets minimum length.
- 2) Power trim and/or adjustable spoilers shall be allowed in Super Stock.

**SST 120 Motor Standards** (see also Rule 23, 25, 26)

- 1) All cowling and engine graphics and colors shall be the same as OEM for product identity and may either be OEM or aftermarket.
- 2) SST 120 class can change engine wiring to allow 24-volt starting system.
- 3) The SST 120 class gear cases may have their outside surfaces refinished; however, they must meet the requirements of OPC Engine Specification sheets and the original design. The outside surfaces of the gearcases may be either painted or unpainted. If painted, the color of the paint must be the same as the original factory motor color. If the gearcases are unpainted, any surface finish is acceptable.
- 4) In SST 120 it is permissible to remove, or render inoperable, the engine primer system and plug all primer related holes in the fuel system opened by removing the primer.
- 5) SST 120 engines may have a substitution of a maximum of 6 sleeves of any manufacturer with original porting specifications and the same material will be allowed for repair of damaged cylinders.
- 6) SST 120 reeds may be of any material or design.
- 7) SST 120 cylinder block exhaust port outlet openings may be remachined to the maximum dimensions shown in the OPC Specification Sheet. Only machined openings are acceptable, machined in the same manner as originally done with no grinding or blending of any sharp edges.
- 8) SST 120 cylinder head combustion chamber pockets may have surface refinished. The cylinder head measurements must be within specified dimensions. No welding or repairs in the combustion chamber surfaces will be permitted.
- 9) The Mercury-produced bolt-on plate muffler is an optional part for the SST 120 class. Note that this part fits only the studs-down SST 120 engine.

**D. SST 200 TECHNICAL STANDARDS**

<u>Max. Total Cu. In. Displacement</u>	<u>Min. Boat Length</u>	<u>Min. Boat Weight</u>
154.0 (2.5L)	16'	1,150 Lbs.
122.0 (2.0L)	16'	1,100 Lbs.

**SST 200 Boat Standards** (see also Rule 21)

- 1) Any design of boat including bottom, deck, cockpit openings and seating arrangements is permissible so far as boat meets minimum length.
- 2) Power trim and/or adjustable spoilers shall be allowed in Super Stock.

**SST 200 Motor Standards** (see also Rule 23, 25 and 26)

- 1) All cowling and engine graphics and colors shall be the same as OEM.
- 2) The SST 200 class can change engine wiring to a 24-volt starting system.
- 3) The SST 200 class gear cases may have their outside surfaces refinished; however, they must meet the requirements of OPC Engine Specification sheets and the original design.
- 4) The SST 120 engine, unaltered, is a legal engine in SST 200 class, and must meet the SST 120 class weight.

**4. FORMULA CLASSES**

**A. FORMULA 150 TECHNICAL STANDARDS**

<u>Max. Total Cu. In. Displacement</u>	<u>Min. Boat Length</u>	<u>Min. Boat Weight</u>
165 (2.7L)	16'	1,050 Lbs.

**Formula 150 Boat Standards** (see also Rule 21)

- 1) Any design of boat including bottom, deck, cockpit openings and seating arrangements is permissible so far as boat meets minimum length.
- 2) Power trim and/or adjustable spoilers shall be allowed in Formula 150.

**Formula 150 Motor Standards**

- 1) Standard factory production models of any manufacture may enter F-150. The 200XS SST OptiMax engine, unaltered, is a legal Formula 150 motor.
- 2) All cowlings and engine graphics shall be essentially the same as OEM for product identity, and may be either OEM or aftermarket manufacture.
- 3) All engines must be carbureted with original manufacturer's carburetors, with the exception of the SST 200 OptiMax, which is DFI. Carburetors may be modified to prevent shutting off, hesitating or slogging in the corners or in rough race conditions. The carburetor bores/venturis may not be modified.
- 4) Only 12- or 24-volt starting system is permitted.
- 5) Engines may substitute up to 6 sleeves of any manufacture as long as original port specs are maintained.
- 6) Iron liner engines will be allowed up to .060 over bore for repair.
- 7) Reed blocks and reed petals may be of any manufacturer but must fit within the OEM intake manifold.
- 8) All engines may use aftermarket (non-OEM) pistons, rings, bearings, gaskets and ignition parts.
- 9) Any gearcase, midsection, cowling and transom/trim assemblies are legal. 10) Exhaust stacks must be contained within the driveshaft housing.
- 11) Powerhead parts must be of original manufacturer with no intermixing of various manufacturers parts. The midsections and lower units are exempt from this rule.
- 12) 100ci engines permitted with any modification except open stacks.
- 13) Cylinder heads for engines over 156 cubic inches may be modified by welding and matching their combustion chamber pockets to achieve higher compression. All cylinder and heads will be checked, with heads on, by a closed block liquid cubic centimeter (cc) measurement. Above specification includes spark plug thread hole as follows: 158.4 cu. in. Yamaha - 37 cc, 165 cu. in. OMC - 40 cc, 164 cu.in. Suzuki - 39 cc. Modifications to cylinder heads must not alter pocket location or shape from factory heads.

**F-150 Mercury**

- 1) Standard factory production 2.5L engines may be run with no modification to the block or ports.
- 2) No grinding or additional machining.
  - a) Any Mercury connecting rod may be used in any model Mercury engine. Dome pistons and O-ring heads may not be used.
  - b) 2.5 production blocks may use any tuner.
  - c) No S3000 or 2.5L Nikasil Race blocks allowed.
  - d) 2.5L production blocks require heads of 30 cc volume minimum (flat plate measurement with surface gap plug).
  - e) 2.4L Bridgeport or Oval-port blocks may be used.
    - i. Bridgeport and oval port blocks may use up to a 7 pedal reed block.
    - ii. Carb venturi of 1.312" maximum.
    - iii. Modified Oval port blocks may use any tuner and head.
    - iv. Stock Bridgeport may use a head of 26cc min. and any exhaust tuner.
    - v. Bridgeport blocks may use a head of 26cc min and any exhaust tuner.
  - f) 2.0L Oval port SST 120 type blocks with cast in iron liners may be modified in any way.
    - i. Any reed block assembly.
    - ii. Any Carb venturi.
    - iii. Any exhaust tuner. iv. Any head volume.
  - g) Pre-1989 2.0L Oval-port Champ blocks may be modified and used with:
    - i. Carb venturi of 1.312" maximum
    - ii. Any exhaust tuner.
    - iii. 2.0L head volume 21cc minimum (flat plate).
  - h) 2.0L Bridgeport Champ block may be modified and used with:
    - i. Any reed block assembly.
    - ii. Carb venturi of 1.312" max. iii. Any exhaust tuner.
    - iii. 2.0L head volume 21cc minimum (flat plate).

**F-150 OMC**

- 1) OMC SST 100 engines may be modified.
- 2) OMC engines, may run 165 cubic inch displacement but must maintain stock block, porting and heads. No alterations to these above mentioned components. No grinding or additional machining. No V-8 blocks.

**F-150 Yamaha, etc.**

- 1) May run 158.4 cubic inch displacement engines but must maintain stock block porting and heads. No alterations to the



above-mentioned components. No grinding or machining.

#### F-150 Suzuki

- 1) May run 164 cubic inch displacement engines but must maintain stock block porting and heads. No alterations to the above-mentioned components. No grinding or machining.

### 5. ALTERED CLASSES: MOD U AND GT-1

The OPC Commission reserves the right to modify or change these technical rules at any time to ensure the competitive compatibility of engines, for safety reasons, or in the interest of controlling the participants' cost of racing. Any technical changes must have the support of the OPC Technical Committee.

#### A. GT-1 TECHNICAL STANDARDS

Engine	Merc 2.0 L Carb/EFI	Merc 2.4 L Carb	Merc 2.4 L EFI	Merc 2.5 L Carb*	MERC 2.5 L EFI**	MERC 200XS	Yamaha 2.6 L Carb/EFI	OMC 3.0 L Carb/EFI
RPM Limiter	none	none	none	none	8600	8000	9000	none
Gearcase	any	any	any	any	# 4 SSM	#4 SSM R/L	# 4 SSM	any
E C R (reference only)	any	any	any	6.5:1	6.5:1	91-880118A04	6.5:1	6.5:1
Installed Head Vol. min.	any	any	any	45	45	-	46.3	any
Heads	any	any	any	36cc spec	36cc spec	51cc	any	any
Intake	any	3 two barrels	any	3 two barrels	Merc Spec	2.750	any	any
Total Min. Weight	1050	1050	1100	1155	1155	1155	1155	1200
Boat Min. Length	16	16	16	16	16	16	16	16
Gearcase Torpedo Min.	R=2.25	R=2.25	R=2.25	R=2.25	R=2.54	R=2.54	R=2.54	R=2.461

\*iron sleeved fishing engine (No Nikasil Racing Blocks)\*\*Nikasil/iron sleeve race or fishing

Mercury 2.5 L EFI engines: Fuel Pressure minimum deadhead 95 lbs. Fuel Pressure minimum flow-through 53 lbs. Only OEM fuel injectors are permitted. Gearcases may have the outside shape blueprinted but no modifications to the internal parts allowed. All gearcase components must be in place and in working order.

3.0 L is the maximum total displacement for GT-1 engines.

**GT-1 Boat Standards** (see also Rule 21): Any design of boat including bottom, deck, cockpit openings and seating arrangements shall be permissible so far as boat meets minimum length.

#### GT-1 Motor Standards

- 1) All motors must run with engine cowls and product identification in place.
- 2) Altered motors must be originally outboard.
- 3) Exhaust stacks not contained in the driveshaft housing will not be permitted.
- 4) It is permissible to change a powerhead and/or gearcase during the course of an event without loss of position if, in the opinion of the inspector, a unit has failed and is beyond repair.
- 5) Only 12- or 24-volt starting system is permitted.

**Mercury 2.5 Liter Race Engine:** Any component of the engine may be modified, substituted or changed with the following exceptions and/or reservations:

- 1) Total engine displacement must not exceed 153.1 cubic inches. Overbore is allowed in no more than two cylinders. Bore=3.500 X Stroke=2.650 inches.
- 2) Total combustion chamber volume must not be less than 45.0 cc. The power head will be removed and placed in such a manner that the cylinder to be measured will be in a vertical plane; the piston in that cylinder will be brought to a top dead center position; no less than 45.0 cc of liquid must fit completely into the combustion chamber below the top of the spark plug hole in the cylinder head. No dome pistons allowed.
- 3) Cylinder head combustion chamber volume must not be less than 36.0 cc. on cylinder heads using head gaskets. The only allowable cylinder heads are manufactured by Mercury Marine using the lost foam method. Head combustion volume will be measured using the flat-plate method with the standard BUHW spark plug installed. When measuring the O-Ring head, the flat-plate volume will be 43.4 cc. A head should maintain stock configuration and appearance.
- 4) The minimum distance from the head parting surface to the piston is .040 inches. A micrometer or vernier caliper will be used to determine the thickness of the head gasket just removed from the inspecting engine. A bridge tool will be used to measure the piston protrusion from the block. The piston protrusion is subtracted from the gasket thickness. An average of all 6 cylinders will be calculated to determine the final dimension. Final dimension must be .040 or greater to be considered legal. When checking the O-Ring head, a vernier caliper or depth micrometer will be used to determine the depth of the "squish band" at the outer diameter of the band. A bridge tool will be used to measure the piston protrusion from the block. The piston protrusion is subtracted from the "squish band" depth. The resulting number must be 0.040" or greater to be considered legal.
- 5) All Mercury 2.5 Liter engines must run the OEM electronic fuel injection (EFI) system. Only the Mercury air horn with a horizontal shaft and one air inlet is permitted. The air horn must be stock in appearance with a functional butterfly. The maximum diameter of the air horn is 3.405 inches.
- 6) All engines shall be equipped with the Mercury Racing digital ECU fuel injection box P/N 849849A-10 or Mercury Racing digital fuel injection box #8M8023278. This ECU box shall contain the Mercury RPM limiting computer chip 847619-22,

8600 RPM. This ECU box and computer chip must be the only box and chip operable at any time. No other device that controls the supply or delivery of fuel may be utilized in place of these devices, or be present in the boat or motor at any time during racing. The ECU box with the RPM limiting chip must be furnished by Mercury Marine, with the factory seal in place at the conclusion of any racing. No alterations, modifications, or substitutions to the above noted ECU box or computer chip are allowed.

- 7) All engines are required to use fuel pressure regulator P/N 12026-2 (56 PSI Reference).
- 8) All engines are required to have a Shrader valve P/N 0-22-849606 properly installed in the fuel supply system to test fuel pressure.
- 9) Fuel pump inspection: Install fuel pressure gauge onto the Shrader valve. With the engine not running, turn on the fuel pump. Let the fuel flow through the return line to the tank. The minimum pressure must be 53 PSI to be considered legal. Then kink the return line to stop flow; the minimum deadhead pressure must be 95 PSI to be considered legal. Use CAUTION with this test, as some pumps may exceed 150 PSI. The only legal fuel pump is the Weldon brand adjustable or non-adjustable pump.
- 10) No devices that reduce the volume of fuel available to the pump, from the pump, or to or through the injectors may be employed.
- 11) No devices that reduce the volume of fuel available to the pump, from the pump, or to or through the injectors may be employed.
- 12) The only legal fuel injector is Mercury P/N 98818 that was originally supplied with the engine. The Bosch P/N 0280150036 must be stamped on the injector. With all six injectors operating together using a spray test, each injector must deliver 33 +/- 2cc per 5 seconds interval. At least 5 injectors must pass the test. Total volume must exceed 186 cc per 5 seconds. 12) The only allowable gear case is the IV SSM Mercury Racing lower unit and it must be run within the proper tolerances of the GT-1 OPC spec sheet. The intention of this rule is to run the gear case as manufactured. The 15:17 gear ratio is the only legal ratio. The surfaces of the gear case and internal parts may be polished. No alterations other than surface improvements are permitted to the gear case or any parts within. No parts may be removed from the gear case and no additional parts may be added. The water pump and impeller may not be altered. The gear case must be filled with fluid and the amount of fluid contained is inspectable.

**Yamaha 2.6 Liter:** Any component of the engine may be modified, substituted or changed with the following exceptions and/or reservations:

- 1) Total engine displacement must not exceed 158.4 cc. The powerhead will be removed and placed in such a manner that the cylinder to be measured will be in a vertical plane; the piston in that cylinder will be brought to top dead center; no less than 46.3 cc of Marvel Mystery Oil (OPC spec fluid) must fit completely into spark plug hole in the installed cylinder head. No domed pistons allowed.
- 2) All Yamaha engines are required to have a 9000 RPM limit.
- 3) After any two Yamaha powered wins at any Champ and/or APBA sanctioned final event in a given year, the RPM limit will change to 8600 for all following events.

**B. MOD U TECHNICAL STANDARDS**

Max. Total Cu. <u>Centimeter Displacement</u>	Minimum <u>Boat Length</u>	Minimum <u>Boat Weight</u>
less than 2800cc	16'	1050 lbs.
2800cc and over	16'	1250 lbs.

**Mod U Boat Standards** (see also Rule 21)

- 1) Any design of boat including bottom, deck, cockpit openings and seating arrangements shall be permissible so far as boat meets minimum length.

**Mod U Motor Standards** (see also Rule 23-A)

- 1) Modifications: open.
- 2) Altered motors must be originally outboard.
- 3) Exhaust stacks not contained in the driveshaft housing will not be permitted.
- 4) Engines must be equipped with starter; and cowlings must be in place to maintain product identity.
- 5) Altered classes with displacement limits must also be limited to naturally aspirated engines.

**6. NATIONAL LIMITED CLASSES –**

**FORMULA TRI HULL, FORMULA 1**

- A. For all Technical Standards, contact John Schubert 281-238-0060
- B. All APBA General Racing and Safety Rules must be complied with. Kill switches, foot throttles and driver's seats are mandatory. Motor kill switches (tether, on/off or push button) must be accessible and clearly marked on the left side of the boat. Rollover or gravity kill switches are also required in case the boat is overturned.

**7. SPORTSMAN CLASSES**

**A. SPORTSMAN CLASS MINI GT TECHNICAL STANDARDS**

- 1) Boat: Minimum Length 10'0"  
Minimum Weight 600 lbs.
  - a) Boats must be of tunnel or V-bottom design; no Hydros.

- b) Boat must be minimum beam of 48" (width).
  - c) Drivers must remain in a sitting position at all times, in a seat securely fastened to the hull, and use a foot throttle and steering wheel.
  - d) Junction of seat and seat back may not be more than 36" rearward of midships.
- 2) Engine:
- a) Any advertised 25 horsepower engine is permitted.
  - b) Engines must remain stock (as manufactured) with the following exceptions:
    - RPM limiters and oil injection may be removed.
    - Electric starter may be added.
    - Solid or pinned motor mounts are allowed.
    - Engines must be bolted securely to the transom with a minimum of two bolts.
    - Power trim, manual trim or spoilers, adjustable while underway, are not permitted.
    - An ignition interrupt switch attached to the driver via tether is required.
- 3) Propellers:
- a) Aluminum props only.
  - b) Cupping, re-pitching and removal of material is permitted.
  - c) No material may be added to a propeller.

**B. SPORTSMAN CLASS GT PRO TECHNICAL STANDARDS**

- A) Minimum driver's age: 12
- B) Motors (See also Rules 24 and 25 regarding replacement parts and modifications.)
- 1) Any 25 horsepower (small bore carburetor), two cylinder, 31.8 cid., thru-hub Johnson or Evinrude;
  - 2) Any 30 or 35 horsepower (large bore carburetor), two cylinder, 31.8 cid. Johnson or Evinrude is allowed
  - 3) Unlimited part swapping with parts original to the 31.8 cid. OMC powerhead is allowed.
  - 4) Engines must be stock—as manufactured (no blueprinting)—with the following exceptions:
    - i. RPM limiters and oil injection systems may be removed.
    - ii. Electric start may be added.
    - iii. Solid or pinned motor mounts are allowed.
    - iv. Tiller arms may be removed.
    - v. Air silencers may be removed. vi. Skeg wear bar may be removed.
    - vii. Under-flywheel ignition may be converted to powerpack ignition using OEM or aftermarket parts/kits.
    - viii. Neutral start switch may be removed.
    - ix. Cylinders may be bored .30 over and fitted with OEM oversize pistons.
    - x. Reeds of any material, OEM or aftermarket, are allowed. xi. Cosmetic appearance of engine may be changed.
  - 5) 30/35 hp only: Power trim, manual-trim or spoilers, adjustable while the boat is underway, are allowed. Up to 24 volt starting system allowed.
  - 6) Transom adapters for raising, lowering or extending the engine will be allowed, but must be fixed while underway.
  - 7) Two 1" diameter holes that can be readily plugged (for testing) may be drilled in the lower unit above the cavitation plate.
  - 8) Cosmetic appearance of engine may be changed.
  - 9) Engines must be securely bolted to the boat with a minimum of two bolts.
- C) Boats: 10'0" long, 48" wide minimum; Minimum Weights: 30/35 hp -- 650 Lbs.; 25 hp -- 525 Lbs.
- 1) Homebuilt, custom-built or production boats of any material are allowed.
  - 2) Boats may be V-bottom, modified vee or tunnel (no hydroplanes), with four inch minimum tunnel depth at transom.
  - 3) Drivers must be sitting in a seat at all times, using a foot throttle and steering wheel.
  - 4) Junction of seat and seat back may not be more than 36" rearward of midships.
  - 5) Boats will be required to start off plane.
- D) Propellers: Any propeller, prop nut, washer and thrust washer are allowed.

**C. VP 75 TECHNICAL STANDARDS**

<u>Total Cu. In. Displacement</u>	<u>Min. Boat Length</u>	<u>Min. Wt.-Boat, Engine, Driver</u>
45 to 49.9 cu. in.	13'	900 lbs.

- 1) Boats must be molded V-bottoms.
- 2) Capsule and roll cages are allowed.
  - a) Boats with less than 20" of molded depth at the driver's seat (external keel to top of gunnel) must have a roll cage per APBA Super Sport class specs.
- 3) Driver's seat must not be more than 36" aft of midships.
- 4) Steering: Mechanical push/pull (Ride Guide style) or Cable and Pulley Steering is allowed per APBA OPC standards.
- 5) Engines must be stock production and mass marketed class E (49.99 cu. In. max. total piston displacement. An overbore of up to .040 is allowed.
- 6) Power trim is not allowed. Engines with factory power trim must be operable at the transom only, or disconnected. In addition, all engines must be tied down to prevent kick-up.

- 7) Thrust jacks and upper mount snubbers are allowed. (No solid mounts allowed.)
- 8) Engine Modifications:
  - a) Tilt switches, oil injection and rev limiters may be rendered inoperative.
  - b) Two 1 inch diameter holes can be drilled in the lower unit above the cavitation plates (readily plugged for testing and water skiing).
  - c) Cosmetic appearance may be changed.
- 9) Propellers - any through hub allowed.
- 10) Engines must be mounted such that when trim parallel to running surface, the center line of the propeller shaft is located 5 inches below the running surface.
- 11) 20-inch midsection only is allowed.

#### **D. SUPER SPORT TECHNICAL STANDARDS**

Minimum Boat Length ..... 17' 9"  
 Minimum Weight ..... 1600 lbs.

##### **Super Sport Standards**

- 1) V-Bottom and Flatbottom boats are permissible in Super Sport. The rectangular area of the bottom extending from the aft end to a transverse line four feet forward of the aft end of the boat bottom, and one foot on either side of the boat centerline, are subject to the following limitations.
  - a) No part of this area shall be above any part of the boat bottom outside this rectangle, with the exception of the longitudinal grooves of a depth not to exceed two (2) inches formed by strakes or lengthwise steps.
  - b) Any devices to extend the engine set-back will be allowed, provided that the distance from the trailing edge of the bottom rectangular area to the top of the engine mounting point—including any spacers, jack plates, brackets or set-backs—does not exceed thirty (30) inches.
- 2) Modified Tunnel Boats will be allowed in the Super Sport. These boats must have a center pod. Starting at the transom, the center pod must be a minimum of eight (8) inches wide and extend even with or below the plane created by the lowest part of the outside sponsons from the trailing edge of the pod to thirty-six (36) inches forward. The outside sponsons may extend a maximum of three (3) inches aft of the center pod, including any protrusions, extensions, or fins attached to the outside sponsons. Any devices to extend the engine set-back will be allowed, provided that the distance from the trailing edge of the center pod to the top of the engine mounting point—including any spacers, jack plates, brackets or set-backs—does not exceed thirty (30) inches. *See Figures H and I.*
- 3) The length of all boats will be measured as originally manufactured.
- 4) Modifications may be made to the hull bottoms during or after production, provided that any hull modifications comply with these rules.
- 5) Modifications to the deck of the boat may be made to accommodate the addition of capsules and/or roll cages.
- 6) All boats used in this class must be molded Fiberglass or composite construction. Any modifications shall be made of similar or like materials.
- 7) Dual cable (i.e.: Ride Guide-type) hydraulic, or electric-assisted hydraulic, steering will be permitted in this class.
- 8) All Super Sport boats are required to have a driver restraint reinforced cockpit or roll cage with driver restraint. (See OPC Safety Rule 9)

##### **Super Sport Motor Standards**

- 1) Legal Super Sport Engine Manufacturers and Models: D.F.I. 150 horsepower, as listed in the current OPC Technical Manual and Specification Book, available online at [www.OPCRace.com](http://www.OPCRace.com) under Rules and Regulations.
- 2) All engines are 20" shaft, standard right hand rotation single prop design gearcases. Motors must be production 2-stroke or 4-stroke, meeting USA environmental emission standards applicable in the year the motor is raced.
- 3) No form of lifting the engine while underway will be allowed.
- 4) All Super engines must comply with OPC Rule 20, A, B and C. Exceptions are as follows:
  - a) Rule 23, 2. F. Studs may not be substituted.
  - b) Rule 23, 2. G. RPM Limiting devices may not be eliminated.
  - c) Rule 23, 2. C. [spark plugs only] The only legal spark plugs are those part numbers recommended by the engine manufacturer for that model engine.
  - 5) It is permitted on all brands to pin the Prop Shaft Bearing Carrier by using flat head screws.
  - 6) Low water pickups and nose cones allowed.
  - 7) Open/Venting exhaust by removing interior exhaust baffle and vent above the anti-ventilation plate.

##### **Super Sport LeMans Start:**

- 1) Use Rule 6, 2 B. in its entirety except for paragraph 7). Super Sport replacement for paragraph 7): When the one-minute gun is fired and a countdown begins, all engines must be running in neutral.

#### **RULE 21 • BOAT STANDARDS**

1. The length is to be measured parallel with the fore and aft centerline from the rear of the transom at the point of engine attachment, to the foremost part of the bow. A tolerance of two inches will be allowed in measuring overall boat length dimensions.
2. No add-on extensions to the hull will be permitted to achieve class length. Fins are not included in measurement of boat length

(see Figure L).

3. The minimum weights assigned to a specific class shall include motors, steering systems, motor controls, hardware, instruments, and all securely attached cushions, fuel tanks and brackets, batteries and boxes, fire extinguishers, etc. Any fuel remaining in the tanks at the end of the race will be included in the boat weight. Driver's weight will be included with life jacket and helmet and clothing as raced. No water will constitute any part of the total class weight. All weights other than the driver, engine and its controls, and fire extinguishers, must be fastened in such a manner that their centers of gravity cannot be moved during the race. Except in races of longer than one-half hour duration per heat, only one fuel tank will be allowed. No weights, other than the engine and its controls, may be fastened in locations external to the hull where they may constitute a hazard upon impact with another object.
4. In questionable cases, acceptability of a given hull shall be the responsibility of the Referee and his decision shall be final.
5. All boats constructed with false floors, seat box compartment or air filled flotation tanks must be fitted with inspection holes of at least 7/8" diameter such that no point inside said tank is more than 24 inches from inspection hole. These holes may be plugged during competition but must be open for weighing and inspection.
6. There shall be no devices or arrangements specifically to take advantage of external air pressure to produce or assist planing.

## **RULE 22 • BOAT NUMBERS**

1. Owners are to fasten their assigned numbers to each side of the boat in such a manner that the number is readily visible to the officials. Numbers must remain intact throughout the race. Failure of the number to be visible may disqualify the boat. Black numerals on a white background that is approximately elliptical or rectangular in shape, or the reverse of the preceding, is acceptable. Vertical block characters shall be used and be a minimum of twelve inches (12") high and a minimum stroke of two inches (2"). Less than 12" minimum is acceptable only if the surface area will not allow otherwise, and the numbers must be as close as possible to the stated minimum standards. Should the background be the same color as the adjacent section of the boat, a 1/2" contrasting, approximately elliptical or rectangular, border is required. Spacing between numbers, and between borders and numbers, must be at least two inches (2"). Numbers, as well as the background and borders may not be angled or tilted. The National Office assigned number must take precedence in case of a number conflict. The legality of any boat numbering is the responsibility of the Race Committee only and cannot be protested.

## **RULE 23 • OUTBOARD MOTOR STANDARDS**

1. An outboard motor is defined as a complete internal combustion power and propulsion unit that can be attached to a boat and which can be lifted bodily from the hull as one unit. Batteries used for ignition and starting, tachometer, throttle control and steering arrangement are excepted.
2. A manufacturer of outboard motors for Outboard Performance Craft Racing is one who filed specifications and is responsible for the original design and manufacture of the following: crankshaft, connecting rod, cylinder head, cylinder, crankcase, gears and valving arrangement, and who complied with such other requirements as provided by these rules. Manufacturers may be of either foreign or USA (domestic) origin, and motors must be or have been available in the USA through dealer networks.
  - A. Motors must be the product of a recognized manufacturer engaged in the production of outboard motors offered for sale to the general public.
  - B. There shall be no alterations of parts with the exception of spark plugs, carburetor jets, and propellers, or specific parts approved by the Technical Committee and approved by the Commission. The intention is to race the engine exactly as manufactured and without special performance boosting accessories. The gearcases on motors raced in Stock classes must be raced with either the same surface coating or paint as supplied by the manufacturer, or with no surface coating or paint over part or all of the surface of the gearcase casting, but the smoothness of the metal surface must under no circumstances be better than that supplied by the manufacturer.
  - C. No special parts or interchange of parts will be allowed, unless approved by the Commission.
  - D. In all classes the trim tab, thrust and locking washers may be altered or removed from the lower unit to permit the use of any propeller, thrust washer or nut.
  - E. Cylinder head and power head attaching studs may be substituted for bolts.
  - F. Electronic engine RPM limiting devices may be eliminated.
3. Stock Engines (Outboard) as referred to in these rules shall be defined as outboard models that:
  - A. All engines in Stock classes must be capable of shifting from the driver's seat, with one hand on the steering wheel, by electric or mechanical methods; and be capable of forward and reverse shifting at all times.
  - B. Are manufactured in annual or model year quantities of greater than 250 units.
  - C. Are intended for sale to and to be used by the general public.
  - D. Are advertised through the same media, in the same publications and given the same prominence as the manufacturer's other engines.
  - E. Are distributed through the manufacturer's normal channels.
  - F. Are not equipped with an accessory or high-speed gearcase.
  - G. Are equipped with standard under-cavitation plate or through-prop exhaust.
4. Super Stock Engines (Outboard) as referred to in these rules shall be defined as outboard models that:
  - A. Are manufactured in annual or model year quantities of more than 25 units.
  - B. Are not necessarily intended for sale and to be used by the general non-racing public.
  - C. Are not necessarily advertised through the same media, in the same publications and given the same prominence as the manufacturer's other engines.
  - D. Are not necessarily distributed through the manufacturer's normal channels.

- E. Accessory gearcases, as submitted by the manufacturer, may be used in these engines provided that they are built in a total quantity of no less than 25.
  - F. Exhaust stacks not contained in the driveshaft housing will not be permitted.
  - G. Standard factory production models may run in Super Stock classes.
  - H. Only one manufacturer's engine should be approved per class.
  - I. No Stock or Super Stock motor shall be eligible for Outboard Performance Craft (OPC) racing until such time as the model has been approved by the OPC Racing Commission.
5. Engines run in Stock and Super Stock classes may only be run in the configuration that they were homologated in by the Technical Committee.

## **RULE 24 • MOTOR MANUFACTURER'S REGISTRATION**

1. The procedure for registration of motors is as follows:
  - A. The manufacturer shall submit ten (10) copies of the engine specifications to the Chairman of the Motor Technical Committee no later than September 30. A copy of this correspondence shall be sent to the OPC Chairperson and to the Executive Administrator, APBA National Headquarters.
  - B. The Chairman of the Technical Committee, upon receiving the engine specifications, shall expeditiously survey all members of the Technical Committee for their approval or objections.
  - C. The manufacturer shall submit one copy of his full line folder for the succeeding model year to the OPC Chairperson by September 30th of each year, showing all models which are candidates for Stock OPC approval.
  - D. Final approval of specifications of a new engine model will be contingent on the Technical Committee inspecting said model and verifying that the specifications represent the model and that the letter of the rules is not violated by this model, and therefore report its findings to the OPC Chairperson.
  - E. After receipt of a recommendation on the adequacy, form and details of the specifications from the Chairman of the Technical Committee, it will be at the discretion of the OPC Chairperson to approve the specifications and poll the OPC Racing Commission.
  - F. Final approval for use in Outboard Performance Craft racing of any motor described above shall not be given until the Chairperson of the OPC Racing Commission has advised the APBA National Office that he is satisfied that all provisions of the rule have been met with, and until such time as the Chairperson shall have specification sheets on the motor sufficient to supply the appointed inspectors at regattas, and until such time as the manufacturers have built at least 250 motors of the model submitted for registration except Super Stock engines.
  - G. New Models: Motor specifications, as defined in the foregoing parts of this rule, shall be frozen for the period of one racing year, effective November 1 through October 31. All approved engine makes and models must be published in Propeller as soon as possible.
  - H. New Stock Models: No models shall be approved for competition between February 1st and November 1st for that racing year.
  - I. New Super Stock Models: No models shall be approved for competition between May 1st and November 1st for that racing year.
  - J. No motor shall be eligible for Outboard Performance Craft racing until such time as the model has been registered with the OPC Racing Commission by the motor manufacturer and until such time as the model has been advertised for sale to the general public and is available for purchase through retail dealers for national distribution prior to January 1st of a given racing season, except Super Stock engines which are often sold directly by the manufacturer.
  - K. Models approved are eligible for competition after notification of the OPC membership, starting no earlier than November 1st or no later than January 1st.
  - L. In cases of questionable integrity, the OPC Chairperson may poll the OPC Commission regarding a candidate model.
  - M. In all cases it shall be the responsibility of the present OPC Chairperson and present Commission to perform all steps for approval of new Stock models.
  - N. If, after September 30, racing rule changes are approved allowing additional non-registered motors to compete in a class, the manufacturers must submit specifications, etc., prior to December 31st in compliance with sections (1) and (3) of this rule.
  - O. Engines will have major part component groups. Any changes of these parts are limited to the original manufacturer of the same. Any changes to any of these groups carry the same requirements of payment and part quantities.
    - 1) Cylinder and crankcase assembly.
    - 2) Crankshaft assembly (includes crank parts, rod and piston).
    - 3) Induction system assembly.
    - 4) Ignition.
    - 5) Midsection assembly.
    - 6) Gearcase assembly.
    - 7) Any bore or stroke change constitutes an engine homologation.
    - 8) Parts or component groups not listed above will be considered minor parts.
  - P. Homologation fees will be reviewed on an annual basis. New engine homologation \$600.00. Major part homologation \$250.00. Minor part homologation \$150.00. Payment, drawings, pictures and related data on parts and/or engines must accompany the same when submitted. All are to be sent to the OPC Chairperson and are not refundable. Fees are to be put into the OPC Promotional Fund and a separate accounting of these funds for the Motor Technical Committee will be maintained.
2. Prototype engines may be raced in established classes, with no points or prizes, at the discretion of the Race Committee. Approval of this testing must be given to the manufacturer at the APBA Annual Meeting by the OPC Commission. In races with

national high point totals, drivers must be polled when a new motor is being tested or included in a class.

## **RULE 25 • REPLACEMENT PARTS**

1. Only such parts shall be permitted as are standard production OEM parts used on the motor as the purchaser may obtain it from the dealer as a stock item or electrical or electronic products as approved by the OPC Technical Committee and the OPC Commission, and published in Propeller and available to the general public through dealers. These products cannot provide any performance advantage over original OEM parts.
  - A. No replacement part for current production motors (motors currently being produced by the original manufacturer) shall be considered standard production until this part appears on current production motors which can be purchased from the dealers.
  - B. Engine components are of two categories: primary and secondary parts.
    - 1) Primary components are: Block and crank case assembly; cylinder head; crankshaft; connecting rods; pistons; wrist pins; induction system; reeds (SST 45 & SST 60); cooling system (must retain original cooling concept); midsection; exhaust; and gear case assembly. No alterations of these components are allowed unless specifically specified in the class rules. Primary parts must be OEM for the model.
    - 2) Secondary components are: Bearings; seals; impellers; cylinder sleeves; gaskets (must be same design and thickness); fuel lines and fitting; ignition wires (high tension) and caps or boots. Secondary parts may be of any manufacture and must be of same design intent and configuration as the OEM parts.
  - C. Any replacement part for non-current motors (motors no longer being produced by the original manufacturer) shall be approved only after the part being replaced is no longer available for the motor model from the manufacturer or is specifically approved by the Commission.
  - D. Final approval of non-OEM electrical or electronic parts approved for use in OPC racing shall not be given until the Chairman of the OPC Racing Commission has advised the Executive Administrator that he is satisfied that all provisions of the rule have been complied with, and until such time as the manufacturers have built at least 250 units of the part submitted for homologation.
  - E. For non-OEM electrical or electronic parts, the manufacturer must follow the same rules as specified for motor manufacturer registration with respect to submission of specifications to the Chairman of the Technical Committee and the time period for which the parts are approved.
  - F. The OPC Technical Committee reserves the right to retain all submitted electrical or electronic parts for a one year period.

## **RULE 26 • MOTOR MODIFICATIONS**

### **Stock and Super Stock classes:**

1. There shall be no modifications whatsoever to the motor as furnished by the manufacturer other than:
  - A. Any carburetor jets, spark plugs or propellers may be used, provided other parts are not altered to accommodate them with the exception of the trim tab.
  - B. Only such parts shall be permitted as are used by the motor manufacturer on the particular model as built on the production line (see Rule 23). Modifications covered by a manufacturer's service or engineering bulletins are legal seven days after the date of any such bulletin and approval by the OPC Technical Committee, provided all direct purchasers of affected engines are notified by mail as well as all OPC inspectors, followed by printing in Propeller at the next opportunity. In the event the manufacturer is unwilling or unable to meet these criteria, modifications covered in such bulletins will be legal after printing in Propeller.
  - C. Oversize pistons furnished by the manufacturer of an outboard motor may be used in the model for which they are furnished. The bore of the engine may be enlarged by the amount that the oversize pistons differ from the standard size pistons. An additional total 0.005 inch enlargement of the bore will be allowed for bore enlargement due to wear or re-matching errors, or measuring tolerance. Under no circumstances may the bore be enlarged more than 0.035 inch over the original dimension. It is not permissible to chromium plate cylinder walls unless the motor manufacturer uses chrome plating of cylinder walls as standard production procedure on that particular model.
  - D. Tachometer, fuel and water pressure, and temperature gauges may be installed if desired.
  - E. The attachment of a steering bar or its equivalent may be accomplished at any point or points on an engine. Any cowlings or plates removed may be cut, and must be replaced. Any openings created by this operation must be sealed to prevent the engines from pulling in air. Studs or bolts may be exchanged to secure steering bar.
  - F. Throttle return springs will be allowed on engines; however, no drilling of holes or other modifications to the engine will be permitted to install same. Mounting links may be attached with present fasteners.
  - G. Isolation Mounts: Only those supplied by the engine manufacturer as original equipment or through the service group are acceptable.
  - H. Any adjustments of mixture control, throttle and shift linkage will be allowed. Any mechanical adjustments of spark advance will be allowed provided no modifications are made either to the spark advance system or the engine as manufactured.
    - I. Safety tilt switches and safety starting switches may be disconnected or bypassed.
  - J. Fuel pumps, filters, heat exchangers or auxiliary tanks may be installed, provided their use entails no modification to the engine and fuel lines used to connect to the fuel connector provided with the engine.
  - K. The attachment of a power trim system may be accomplished at any point or points on an engine. Only those parts of the production motor interfering with the attachment and function of the trim system may be altered or removed.
  - L. Bead blasting will be allowed at the block and crankcase interface only. No other internal parts may be bead-blasted.

## **RULE 27 • INSPECTION PROCEDURE**

1. Motors, hulls, and other equipment subject to these rules shall be inspected by the inspector and/or designated safety inspector(s) prior to the contestant entering the water at the event, and a report of any violation of rules and regulations submitted at the earliest possible moment to the Race Committee for action.
2. Such equipment shall be available for examination previous to the race and if found not in compliance with any governing rule or regulation, unsafe, unseaworthy, or unmanageable, or if the owner or driver has failed to live up to the rules, the Race Committee may rescind the entry. Correction or substitution may be permitted if made previous to competing in the race, but the start shall not be delayed to allow compliance.
3. Immediately after the finish of a race, contestants shall report with their boats and motors to the Inspector at such place as designated by the Race Committee. The boat and motor shall remain in the custody of the Inspector until dismissed. For the purpose of the enforcement of OPC technical rules, the engine and boat shall be assumed to have been raced in the same condition in which it appears during post race inspection. A boat which flips, or sustains substantial damage in a heat, does not have to meet minimum weight requirements for the heat in which the damage was sustained (at the inspectors' discretion).
4. The Inspectors shall have the power after the finish of any race to order any contestant to dismantle his motor for inspection and measurement. These are the minimum requirements for all events, stated below, and apply to all Stock and Super Stock motors, except SST 200.
  - A. Class 1 Inspection (required at all OPC Nationals, Worlds title & Record events)
    - 1) First Place: Removal of crankcase from cylinder block and inspection for all potential modifications listed in the Inspector's Manual. Also includes A.2 and A.3.
    - 2) Second Place: Inspection of the exhaust pipe(s) and pistons. Also includes A.3.
    - 3) Third Place or random draw: Inspection of cylinder heads, ports, intake and gearcase.
  - B. Class 2 Inspection (required for all OPC approved Series, North American Championships and Divisional title [Championship] events)
    - 1) First Place: Inspection of exhaust pipe(s). Procedure shall also include B.2) and B.3) (below)
    - 2) Second Place: Inspection of heads, ports, intake and gearcase.
    - 3) Third Place or random draw: At the discretion of the Inspector, one or more of the following shall be inspected: cylinder heads, ports, intake and gearcase.
  - C. Class 3 Inspection - (required at all other OPC events) shall be an inspection of external features and specifications.
- 5. SST 200 Motors:**
  - A. Class 1 Inspection (required at all Nationals, World Titles & Record events)
    - 1) First Place: optional removal of crankcase from cylinder block. Inspection for all potential modifications listed in the Inspector's Manual. Also includes A.2 and A.3
    - 2) Second Place: Inspection of the exhaust pipe(s) and one piston. Also includes A.3
    - 3) Third Place or random draw: Inspection of one cylinder head, ports, intake and gearcase.
  - B. Class 2 Inspection (required at all OPC approved Series, North American Championships and Divisional title [championship] events).
    - 1) First Place: Inspection of exhaust pipe(s). Procedure shall also include B.2 and B.3 (below)
    - 2) Second Place: Inspection of one head, ports, intake and gearcase.
    - 3) Third Place or random draw: At the discretion of the inspector, one or more of the following shall be inspected: one cylinder head, ports, intake and gearcase.
  - C. Class 3 Inspection: (required at all other OPC events ) shall be an inspection of external features and specifications. Inspector Note: During the homologation process, the Motor Technical Committee members present observed:
    - 1) When inspecting the heads and ports, the starboard head was easier to remove than the port head.
    - 2) The inlet system can be visually inspected without removal of the plenum.
    - 3) It is possible to remove a piston through the intake without needing to split the crankcase.
    - 4) If a Mercury data reader is available, it is recommended to obtain data from the engine management system to confirm specifications.Any contestant refusing to comply with the orders of the Inspector or Pit Manager or who violates the provisions of Section C of this rule shall be disqualified by the Race Committee.
6. Each winning boat and motor and such others as may be designated by the Race Committee, shall be torn down, inspected, measured and weighed. The Referee may waive inspection except at Regional, Divisional, North American, World and National Championship regattas or if a protest has been filed or records are claimed.
7. The Inspector shall inspect and check the boat with the same powers and requirements defined for motors in other sections of this rule. Boats in each weight regulated class must be weighed at the Inspector's discretion. If the boat is not equipped with a lifting bridle per Rule 4, Section I, it will be disqualified. All water must be removed from the boat prior to weigh-in.
8. The driver shall be responsible for the condition of the motor and hull as raced. Errors on the part of the manufacturer, boat builder, mechanic, or previous owner shall not excuse noncompliance with the rules.
9. The Referee shall record a disqualification on a specific member's card whenever:
  - A. A driver does not report with his boat to the Inspector after a race for inspection.
  - B. A driver refuses to dismantle his engine when asked to by the Inspector.
  - C. A driver forfeits a race rather than submit to inspection.



- D. In the opinion of the Inspector, the driver has defied the rule and competed non-stock equipment. All appropriate paperwork must be forwarded to APBA Headquarters.
10. In case of infractions of any technical rules during a heat, the driver shall be disqualified from that heat.
11. Any technical disqualification during a sanctioned event shall disqualify that participant for all racing preceding the disqualification under that sanction in that class. The participant can compete in future racing once the infraction is corrected.
12. The inspector may impound any component of the racing unit to determine compliance with these rules, and send the impounded components to the appropriate technical committee. No prizes and points for the class will be awarded until the decision is made on the component's compliance with the rules. At that time, the referee will notify the concerned parties of the decision so that positions, prizes and points can be awarded.

#### **RULE 28 - CATEGORY AWARDS**

1. Nominations for Category Awards will be received by the incumbent Category Chairman no later than December 1st for the prior racing season.
2. Category Award recipients will be determined by a majority vote of the current Racing Commission members no later than December 15th.

Figure "A"

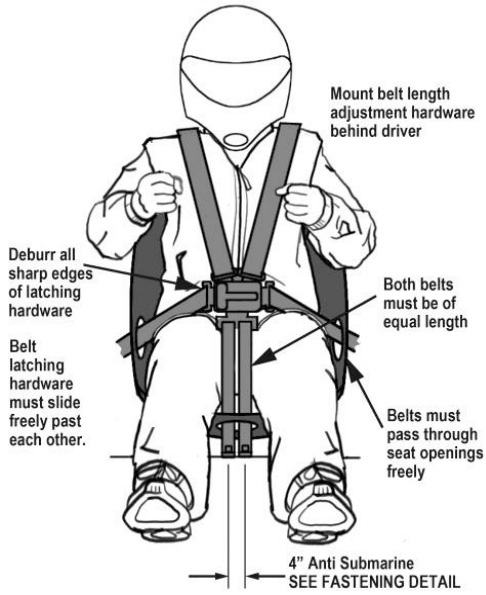

Figure "B" Shoulder Belt Anchoring

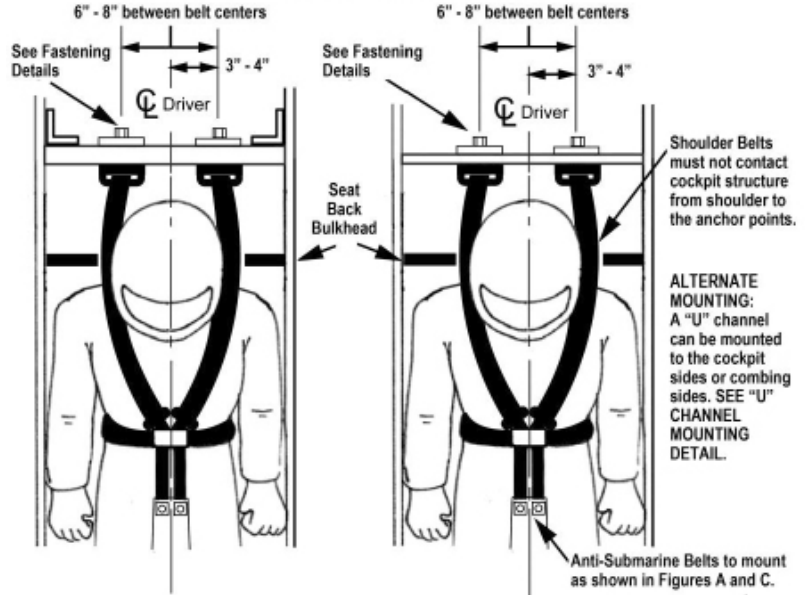
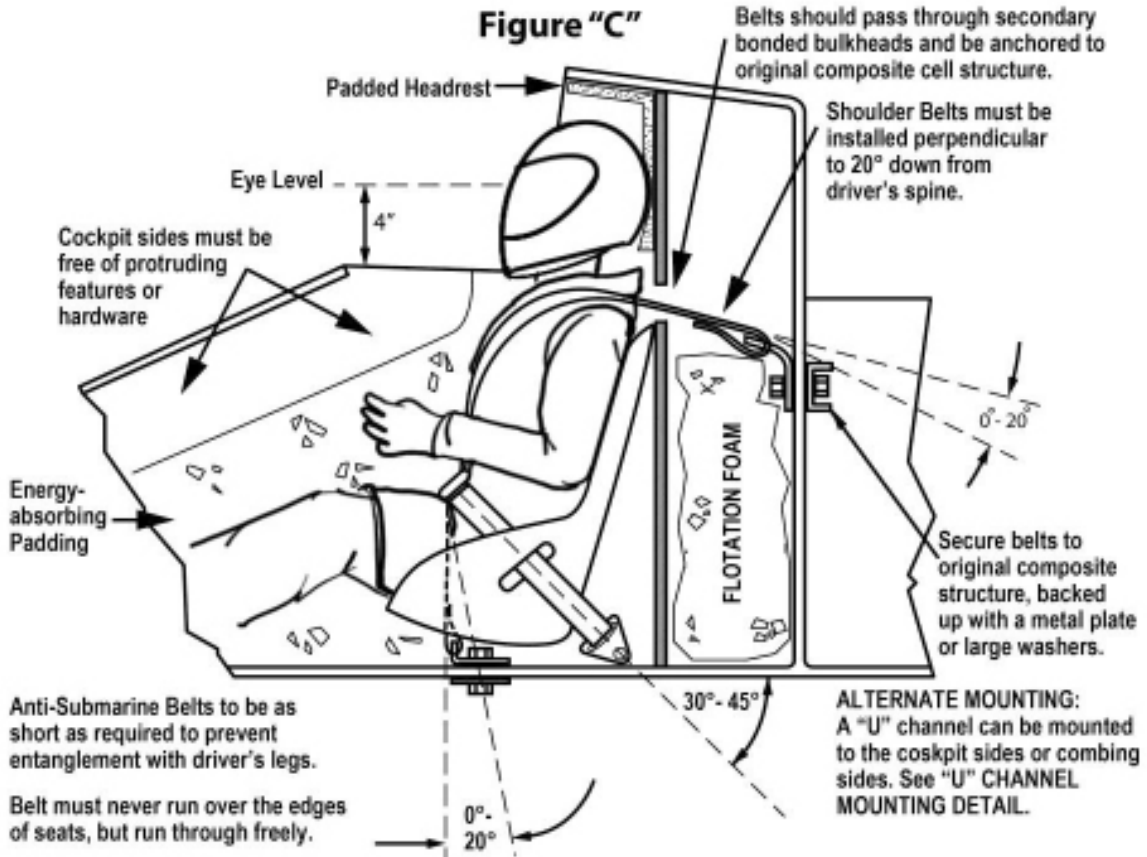
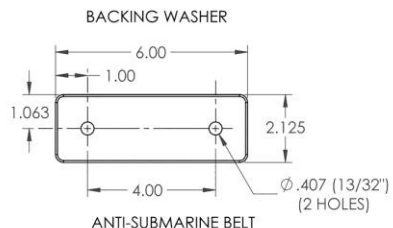
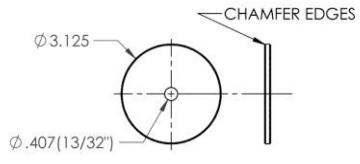
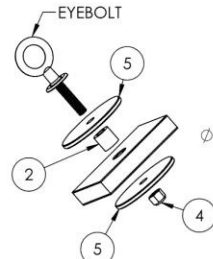
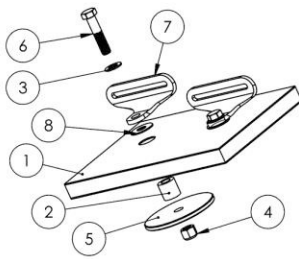

Figure "C"



### FASTENING DETAILS

ITEM NO.	DESCRIPTION	QTY.
1	CELL WALL	1
2	SLEEVE	2
3	FLAT WASHER	2
4	LOCK NUT	2
5	3 1/8" WASHER	2
6	3/8" DIAMETER BOLT	2
7	BELT ANCHOR	2
8	LARGE DIAMETER WASHER	2



MOUNTING FASTENERS TO HAVE A MINIMUM TENSILE STRENGTH OF 150,000 PSI. AND BE CORROSION RESISTANT

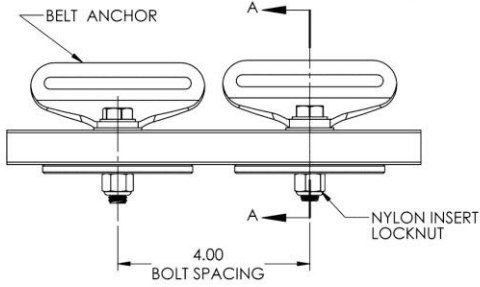

**ANTI-SUBMARINE BELT MOUNTING**

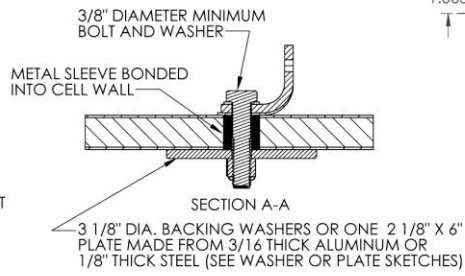

NOTE: THIS SECTION IS TYPICAL OF ALL HARNESS ANCHORING TYPES THAT WOULD PENETRATE THE COCKPIT COMPOSITE STRUCTURE

PARTS REQUIRED		
ITEM NO.	DESCRIPTION	QTY.
1	U CHANNEL	1
2	MOUNTING BRACKET	2
3	LARGE DIAMETER WASHER	14
4	BELT ANCHOR	2
5	3/8 DIAMETER BOLT	10
6	LOCK NUT	10
7	CELL WALL	2
8	SLEEVE	4

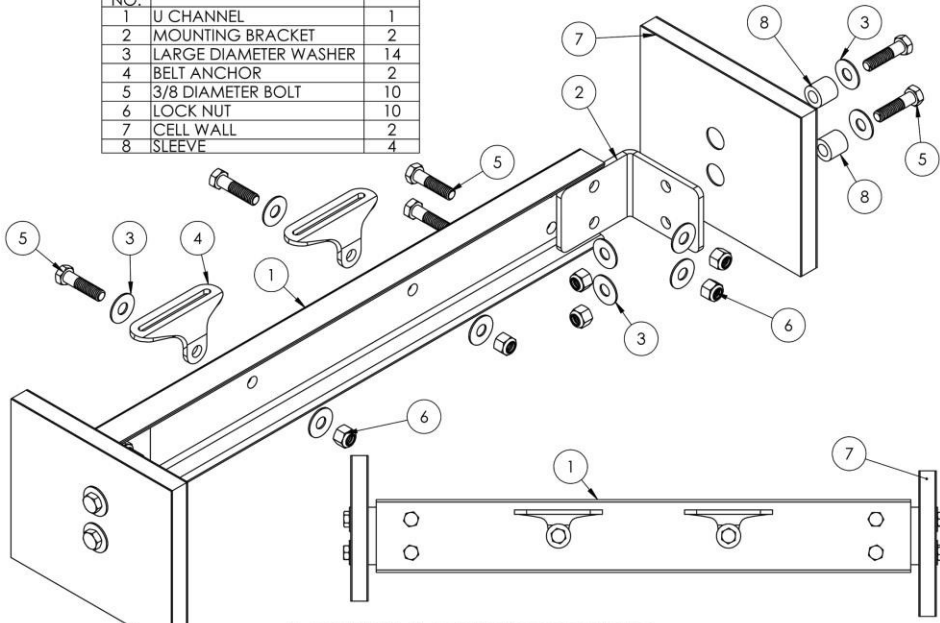

**U CHANNEL MOUNTING DETAILS**

**FIG. D**

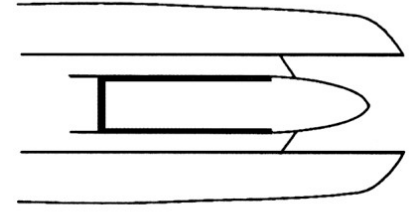

**FIG. E**

